

Xenon™ 1900/1910
Xenon™ 1902/1912
Granit™ 1910i/1911i

Area-Imaging Scanner

User's Guide

Disclaimer

Honeywell International Inc. ("HII") reserves the right to make changes in specifications and other information contained in this document without prior notice, and the reader should in all cases consult HII to determine whether any such changes have been made. The information in this publication does not represent a commitment on the part of HII.

HII shall not be liable for technical or editorial errors or omissions contained herein; nor for incidental or consequential damages resulting from the furnishing, performance, or use of this material. HII disclaims all responsibility for the selection and use of software and/or hardware to achieve intended results.

This document contains proprietary information that is protected by copyright. All rights are reserved. No part of this document may be photocopied, reproduced, or translated into another language without the prior written consent of HII.

© 2010-2014 Honeywell International Inc. All rights reserved.

Web Address: www.honeywellaidc.com

Microsoft® Windows®, Windows NT®, Windows 2000, Windows ME, Windows XP, and the Windows logo are trademarks or registered trademarks of Microsoft Corporation.

The Bluetooth® word mark and logos are owned by Bluetooth SIG, Inc.

Other product names or marks mentioned in this document may be trademarks or registered trademarks of other companies and are the property of their respective owners.

Product Agency Compliance - Xenon 1900/1910

USA

FCC Part 15 Subpart B Class B

This device complies with part 15 of the FCC Rules. Operation is subject to the following two conditions:

1. This device may not cause harmful interference.
2. This device must accept any interference received, including interference that may cause undesired operation.

This equipment has been tested and found to comply with the limits for a Class B digital device pursuant to part 15 of the FCC Rules. These limits are designed to provide reasonable protection against harmful interference in a residential installation. This equipment generates, uses, and can radiate radio frequency energy and, if not installed and used in accordance with the instructions, may cause harmful interference to radio communications. However, there is no guarantee that interference will not occur in a particular installation. If this equipment does cause harmful interference to radio or television reception, which can be determined by turning the equipment off and on, the user is encouraged to try to correct the interference by one or more of the following measures:

- Reorient or relocate the receiving antenna.
- Increase the separation between the equipment and receiver.
- Connect the equipment into an outlet on a circuit different from that to which the receiver is connected.
- Consult the dealer or an experienced radio or television technician for help.

If necessary, the user should consult the dealer or an experienced radio/television technician for additional suggestions. The user may find the following booklet helpful: "Something About Interference." This is available at FCC local regional offices. Honeywell is not responsible for any radio or television interference caused by unauthorized modifications of this equipment or the substitution or attachment of connecting cables and equipment other than those specified by Honeywell. The correction is the responsibility of the user.

Use only shielded data cables with this system. This unit has been tested with cables less than 3 meters. Cables greater than 3 meters may not meet class B performance.

Caution: Any changes or modifications made to this equipment not expressly approved by Honeywell may void the FCC authorization to operate this equipment.

UL Statement

UL listed: UL60950-1, 2nd Edition.

Canada

Industry Canada ICES-003

This Class B digital apparatus complies with Canadian ICES-003. Operation is subject to the following conditions:

1. This device may not cause harmful interference.
2. This device must accept any interference received, including interference that may cause undesired operation.

Conformité à la réglementation canadienne

Cet appareil numérique de la Classe B est conforme à la norme NMB-003 du Canada. Son fonctionnement est assujéti aux conditions suivantes :

1. Cet appareil ne doit pas causer de brouillage préjudiciable.
2. Cet appareil doit pouvoir accepter tout brouillage reçu, y compris le brouillage pouvant causer un fonctionnement indésirable.



C-UL listed: CSA C22.2 No.60950-1-07, 2nd Edition.

Europe



The CE marking indicates compliance to 2004/108/EC EMC Directive with Standards EN55022 CLASS B, EN55024, EN61000-3-2, EN61000-3-3 and 2011/65/EU RoHS directive. In addition, complies to 2006/95/EC Low Voltage Directive, when shipped with recommended power supply. European contact:

Hand Held Products Europe B.V.
Nijverheidsweg 9-13
5627 BT Eindhoven
The Netherlands

Honeywell International Inc. shall not be liable for use of our product with equipment (i.e., power supplies, personal computers, etc.) that is not CE marked and does not comply with the Low Voltage Directive.

Honeywell Scanning & Mobility Product Environmental Information

Refer to www.honeywellaidc.com/environmental for the RoHS / REACH / WEEE information.

Australia/NZ

C-Tick Statement



Conforms to AS/NZS 3548 EMC requirement

Mexico



Conforms to NOM-019.

Japan



Russia



Gost-R certificate

South Korea



The product meets Korean agency approval for Class B equipment:

이 기기는 가정용 (B 급) 전자파적합기기로서 주로 가정에서 사용하는 것을 목적으로 하며, 모든 지역에서 사용할 수 있습니다.

Taiwan

If the following label is attached to your product, the product meets Taiwan agency approval:



BSMI Standard: CNS13438, CNS14336

依據標準 : CNS13438, CNS14336

International

LED Safety Statement

LEDs have been tested and classified as “EXEMPT RISK GROUP” to the standard: IEC 62471:2006.

CB Scheme

Certified to CB Scheme IEC 60950-1, Second Edition.

Laser Safety Statement

If the following label is attached to your product, it indicates the product contains a laser engine or laser aimer:

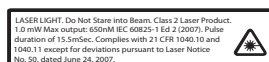

This device has been tested in accordance with and complies with IEC60825-1 ed2 (2007) Pulse duration of 15.5 mSec. Complies with 21 CFR 1040.10 and 1040.11, except for deviations pursuant to Laser Notice No. 50, dated June 24, 2007.

LASER LIGHT, DO NOT STARE INTO BEAM, CLASS 2 LASER PRODUCT, 1.0 mW MAX OUTPUT: 650nm.

Caution: Use of controls or adjustments or performance of procedures other than those specified herein may result in hazardous radiation exposure.

Patents

For patent information, please refer to www.hsmpats.com.

Solids and Water Protection

The Xenon 1900 has a rating of IP41, immunity of foreign particles and dripping water.

Warning



To reduce the possibility of heat-related injuries, avoid touching sections of the scanner that feel warm.

Product Agency Compliance - Xenon 1902/1912 and CCB01-010BT Base

USA

FCC Part 15 Subpart C

This device complies with part 15 of the FCC Rules. Operation is subject to the following two conditions:

1. This device may not cause harmful interference.
2. This device must accept any interference received, including interference that may cause undesired operation.

Caution: Any changes or modifications made to this equipment not expressly approved by Honeywell may void the FCC authorization to operate this equipment.

Use only shielded data cables with this system. This unit has been tested with cables less than 3 meters. Cables greater than 3 meters may not meet class B performance.



UL listed: UL60950-1, 2nd Edition.

Canada

Industry Canada

This device complies with Canadian RSS-210. Operation is subject to the following conditions:

1. This device may not cause interference.
2. This device must accept any interference, including interference that may cause undesired operation.

Conformité à la réglementation canadienne

Cet appareil ISM est conforme à la norme CNR-210 du Canada. Son fonctionnement est assujéti aux conditions suivantes :

1. Cet appareil ne doit pas causer de brouillage préjudiciable.
2. Cet appareil doit pouvoir accepter tout brouillage reçu, y compris le brouillage pouvant causer un fonctionnement indésirable.



C-UL listed: CSA C22.2 No.60950-1-07, 2nd Edition for I.T.E. product safety.

Europe

CE The CE marking on the product indicates that this device is in conformity with all essential requirements of the 1999/5/EC R&TTE Directive and 2011/65/EU RoHS directive. In addition, complies to 2006/95/EC Low Voltage Directive, when shipped with recommended power supply. European contact:

Hand Held Products Europe B.V.
Nijverheidsweg 9-13
5627 BT Eindhoven
The Netherlands

Honeywell shall not be liable for use of our product with equipment (i.e., power supplies, personal computers, etc.) that is not CE marked and does not comply with the Low Voltage Directive. This equipment is intended for use throughout the European Community and has been assessed to the following standards:

EN 300 328
EN 301 489-1
EN 301 489-17

EN60950-1

Waste Electrical and Electronic Equipment Information

Honeywell complies with Directive 2002/96/EC OF THE EUROPEAN PARLIAMENT AND OF THE COUNCIL on waste electrical and electronic equipment (WEEE).

This product has required the extraction and use of natural resources for its production. It may contain hazardous substances that could impact health and the environment, if not properly disposed.

In order to avoid the dissemination of those substances in our environment and to diminish the pressure on the natural resources, we encourage you to use the appropriate take-back systems for product disposal. Those systems will reuse or recycle most of the materials of the product you are disposing in a sound way.



The crossed out wheeled bin symbol informs you that the product should not be disposed of along with municipal waste and invites you to use the appropriate separate take-back systems for product disposal.

If you need more information on the collection, reuse, and recycling systems, contact your local or regional waste administration.

You may also contact your supplier for more information on the environmental performances of this product.

Australia/NZ

C-Tick Statement



Conforms to AS/NZS 3548 EMC requirements.

Brazil

This product is approved by Anatel, according to the procedures regulated by Resolution No. 242/2000 and meets the technical requirements applied.

Este produto está homologado pela ANATEL, de acordo com os procedimentos regulamentados pela Resolução No. 242/2000 e atende aos requisitos técnicos aplicados.

Para maiores informações, consulte o site da ANATEL – www.anatel.gov.br



China

SRRC Radio Certificate.

Japan



Complies with Technical Regulations Conformity Certification of Specified Radio equipment.

Korea



This product meets Korean agency approval.

Mexico



Conforms to NOM-019.

This product meets Cofetel approval.

Russia



Gost-R certificate.

Taiwan

If the following label is attached to your product, the product meets Taiwan agency approval:



BSMI Standard: CNS13438, CNS14336 (Xenon 1902 only)

依據標準 : CNS13438, CNS14336



NCC standard: Low power frequency electric machineries technical standard: LP0002

International

LED Safety Statement

Scanner LEDs have been tested and classified as “EXEMPT RISK GROUP” to the standard: IEC 62471:2006.

Radio Technology



CB Scheme

Certified to CB Scheme IEC 60950-1, Second Edition.

Laser Safety Statement

If the following label is attached to your product, it indicates the product contains a laser engine or laser aimer:

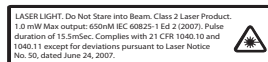

This device has been tested in accordance with and complies with IEC60825-1 ed2 (2007) Pulse duration of 15.5 mSec. Complies with 21 CFR 1040.10 and 1040.11, except for deviations pursuant to Laser Notice No. 50, dated June 24, 2007.

LASER LIGHT, DO NOT STARE INTO BEAM, CLASS 2 LASER PRODUCT, 1.0 mW MAX OUTPUT: 650nM.

Caution: Use of controls or adjustments or performance of procedures other than those specified herein may result in hazardous radiation exposure.

Solids and Water Protection

The Xenon 1902 has a rating of IP41, immunity of foreign particles and dripping water.

Patents

For patent information, please refer to www.hsmpats.com.

Warning



To reduce the possibility of heat-related injuries, avoid touching sections of the scanner that feel warm.

Product Agency Compliance - Granit 1910i

USA

FCC Part 15 Subpart B Class B

This device complies with part 15 of the FCC Rules. Operation is subject to the following two conditions:

1. This device may not cause harmful interference.
2. This device must accept any interference received, including interference that may cause undesired operation.

This equipment has been tested and found to comply with the limits for a Class B digital device pursuant to part 15 of the FCC Rules. These limits are designed to provide reasonable protection against harmful interference in a residential installation. This equipment generates, uses, and can radiate radio frequency energy and, if not installed and used in accordance with the instructions, may cause harmful interference to radio communications. However, there is no guarantee that interference will not occur in a particular installation. If this equipment does cause harmful interference to radio or television reception, which can be determined by turning the equipment off and on, the user is encouraged to try to correct the interference by one or more of the following measures:

- Reorient or relocate the receiving antenna.
- Increase the separation between the equipment and receiver.
- Connect the equipment into an outlet on a circuit different from that to which the receiver is connected.
- Consult the dealer or an experienced radio or television technician for help.

If necessary, the user should consult the dealer or an experienced radio/television technician for additional suggestions. The user may find the following booklet helpful: "Something About Interference." This is available at FCC local regional offices. Honeywell is not responsible for any radio or television interference caused by unauthorized modifications of this equipment or the substitution or attachment of connecting cables and equipment other than those specified by Honeywell. The correction is the responsibility of the user.

Use only shielded data cables with this system. This unit has been tested with cables less than 3 meters. Cables greater than 3 meters may not meet class B performance.

Caution: Any changes or modifications made to this equipment not expressly approved by Honeywell may void the FCC authorization to operate this equipment.



TÜV-R Statement

TÜV R listed: UL 60950-1, Second Edition and CSA C22.2 No.60950-1-07, Second Edition.

Canada

Industry Canada ICES-003

This Class B digital apparatus complies with Canadian ICES-003. Operation is subject to the following conditions:

1. This device may not cause harmful interference.
 2. This device must accept any interference received, including interference that may cause undesired operation.
-

Conformité à la réglementation canadienne

Cet appareil numérique de la Classe A est conforme à la norme NMB-003 du Canada. Son fonctionnement est assujéti aux conditions suivantes :

1. Cet appareil ne doit pas causer de brouillage préjudiciable.
2. Cet appareil doit pouvoir accepter tout brouillage reçu, y compris le brouillage pouvant causer un fonctionnement indésirable.



TÜV-R Statement

TÜV R listed: UL 60950-1, Second Edition and CSA C22.2 No.60950-1-07, Second Edition.

Europe



The CE marking indicates compliance to 2004/108/EC EMC Directive with Standards EN55022 CLASS B, EN55024, EN61000-3-2, EN61000-3-3 and 2011/65/EU RoHS directive. In addition, complies to 2006/95/EC Low Voltage Directive, when shipped with recommended power supply. European contact:

Hand Held Products Europe B.V.
Nijverheidsweg 9-13
5627 BT Eindhoven
The Netherlands

Honeywell International Inc. shall not be liable for use of our product with equipment (i.e., power supplies, personal computers, etc.) that is not CE marked and does not comply with the Low Voltage Directive.

Waste Electrical and Electronic Equipment Information

Honeywell complies with Directive 2002/96/EC OF THE EUROPEAN PARLIAMENT AND OF THE COUNCIL of 27 January 2003 on waste electrical and electronic equipment (WEEE).

This product has required the extraction and use of natural resources for its production. It may contain hazardous substances that could impact health and the environment, if not properly disposed.

In order to avoid the dissemination of those substances in our environment and to diminish the pressure on the natural resources, we encourage you to use the appropriate take-back systems for product disposal. Those systems will reuse or recycle most of the materials of the product you are disposing in a sound way.



The crossed out wheeled bin symbol informs you that the product should not be disposed of along with municipal waste and invites you to use the appropriate separate take-back systems for product disposal.

If you need more information on the collection, reuse, and recycling systems, please contact your local or regional waste administration.

You may also contact your supplier for more information on the environmental performances of this product.

Australia/NZ

C-Tick Statement



Conforms to AS/NZS 3548 EMC requirement

Russia



Gost-R certificate

International

LED Safety Statement

LEDs have been tested and classified as “EXEMPT RISK GROUP” to the standard: IEC 62471:2006.

CB Scheme

Certified to CB Scheme IEC 60950-1, Second Edition.

Laser Safety Statement

If the following label is attached to your product, it indicates the product contains a laser engine or laser aimer:

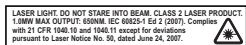

This device has been tested in accordance with and complies with IEC60825-1 ed2 (2007). Complies with 21 CFR 1040.10 and 1040.11, except for deviations pursuant to Laser Notice No. 50, dated June 24, 2007.

LASER LIGHT, DO NOT STARE INTO BEAM, CLASS 2 LASER PRODUCT, 1.0 mW MAX OUTPUT: 650nm.

Caution: Use of controls or adjustments or performance of procedures other than those specified herein may result in hazardous radiation exposure.

Patents

For patent information, please refer to www.hsmpats.com.

Solids and Water Protection

The Granit 1910i has a rating of IP65, totally protected against dust and protected against low pressure water jets.

Warning



To reduce the possibility of heat-related injuries, avoid touching sections of the scanner that feel warm.

Product Agency Compliance - Granit 1911i and CCB02-100BT Base

USA

FCC Part 15 Subpart C

This device complies with part 15 of the FCC Rules. Operation is subject to the following two conditions:

1. This device may not cause harmful interference.
2. This device must accept any interference received, including interference that may cause undesired operation.

Caution: Any changes or modifications made to this equipment not expressly approved by Honeywell may void the FCC authorization to operate this equipment.

Use only shielded data cables with this system. This unit has been tested with cables less than 3 meters. Cables greater than 3 meters may not meet class B performance.



TÜV-R Statement

TÜV R listed: UL 60950-1, Second Edition and CSA C22.2 No.60950-1-07, Second Edition.

Canada

Industry Canada

This device complies with Canadian RSS-210. Operation is subject to the following conditions:

1. This device may not cause interference.
2. This device must accept any interference, including interference that may cause undesired operation.

Conformité à la réglementation canadienne

Cet appareil ISM est conforme à la norme CNR-210 du Canada. Son fonctionnement est assujéti aux conditions suivantes :

1. Cet appareil ne doit pas causer de brouillage préjudiciable.
2. Cet appareil doit pouvoir accepter tout brouillage reçu, y compris le brouillage pouvant causer un fonctionnement indésirable.



TÜV-R Statement

TÜV R listed: UL 60950-1, Second Edition and CSA C22.2 No.60950-1-07, Second Edition.

Europe



The CE marking on the product indicates that this device is in conformity with all essential requirements of the 1999/5/EC R&TTE Directive and 2011/65/EU RoHS directive. In addition, complies to 2006/95/EC Low Voltage Directive, when shipped with recommended power supply. European contact:

Hand Held Products Europe B.V.
Nijverheidsweg 9-13
5627 BT Eindhoven
The Netherlands

Honeywell shall not be liable for use of our product with equipment (i.e., power supplies, personal computers, etc.) that is not CE marked and does not comply with the Low Voltage Directive. This equipment is intended for use throughout the European Community and has been assessed to the following standards:

- EN 300 328
 - EN 301 489-1
 - EN 301 489-17
-

EN60950-1

Waste Electrical and Electronic Equipment Information

Honeywell complies with Directive 2002/96/EC OF THE EUROPEAN PARLIAMENT AND OF THE COUNCIL on waste electrical and electronic equipment (WEEE).

This product has required the extraction and use of natural resources for its production. It may contain hazardous substances that could impact health and the environment, if not properly disposed.

In order to avoid the dissemination of those substances in our environment and to diminish the pressure on the natural resources, we encourage you to use the appropriate take-back systems for product disposal. Those systems will reuse or recycle most of the materials of the product you are disposing in a sound way.



The crossed out wheeled bin symbol informs you that the product should not be disposed of along with municipal waste and invites you to use the appropriate separate take-back systems for product disposal.

If you need more information on the collection, reuse, and recycling systems, contact your local or regional waste administration.

You may also contact your supplier for more information on the environmental performances of this product.

Australia/NZ

C-Tick Statement



Conforms to AS/NZS 3548 EMC requirements.

Russia



Gost-R certificate.

International

LED Safety Statement

Scanner LEDs have been tested and classified as "EXEMPT RISK GROUP" to the standard: IEC 62471:2006.

Radio Technology



Class I

CB Scheme

Certified to CB Scheme IEC 60950-1, Second Edition.

Laser Safety Statement

If the following label is attached to your product, it indicates the product contains a laser engine or laser aimer:

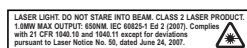

This device has been tested in accordance with and complies with IEC60825-1 ed2 (2007). Complies with 21 CFR 1040.10 and 1040.11, except for deviations pursuant to Laser Notice No. 50, dated June 24, 2007.

LASER LIGHT, DO NOT STARE INTO BEAM, CLASS 2 LASER PRODUCT, 1.0 mW MAX OUTPUT: 650nm.

Caution: Use of controls or adjustments or performance of procedures other than those specified herein may result in hazardous radiation exposure.

Solids and Water Protection

The Granit 1911i has a rating of IP65, immunity of foreign particles and dripping water.

Patents

For patent information, please refer to www.hsmpats.com.

Warning



To reduce the possibility of heat-related injuries, avoid touching sections of the scanner that feel warm.

Required Safety Labels

Xenon 1900/1910/1902/1912 Scanner

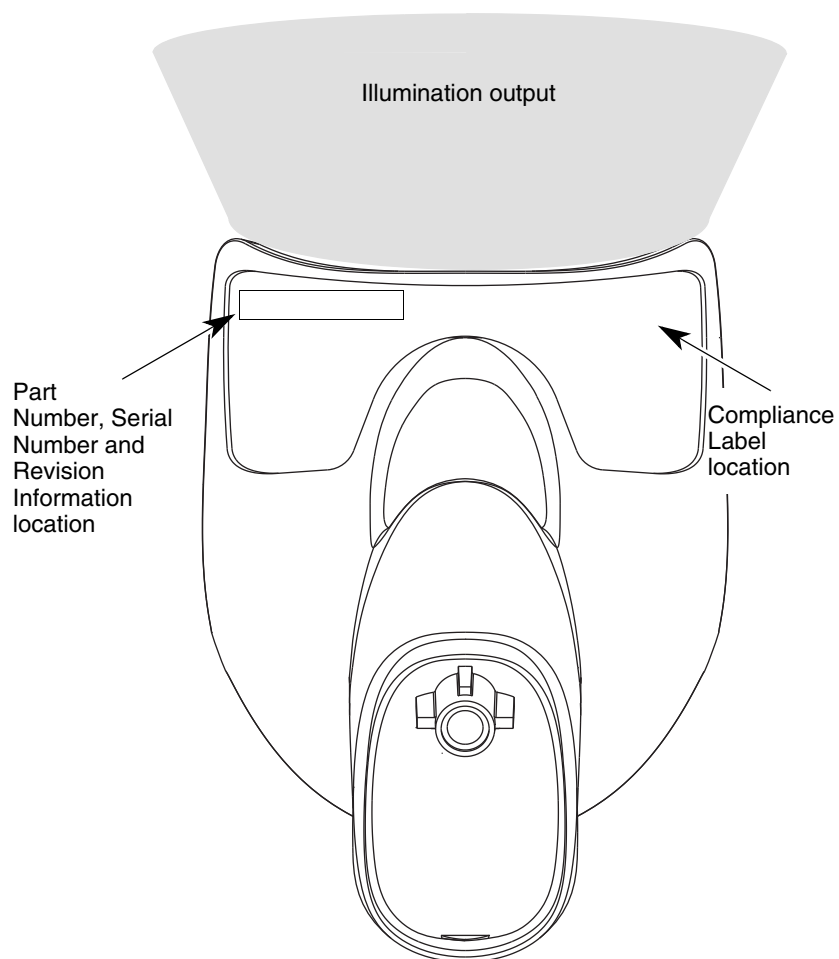

CCB01-010BT Base

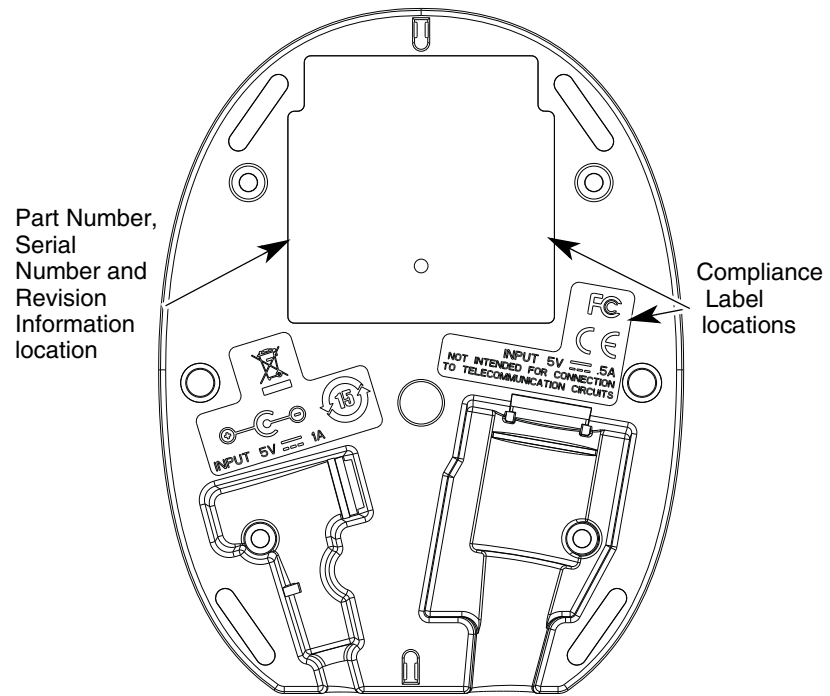

Granit 1910i/1911i Scanner

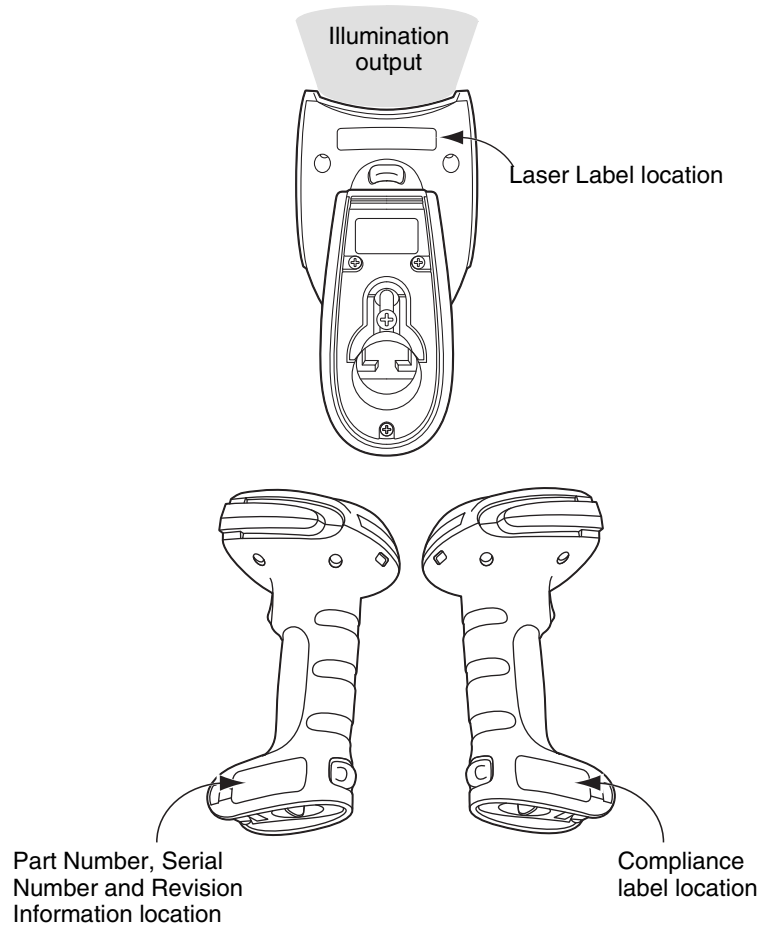

CCB02-100BT Base

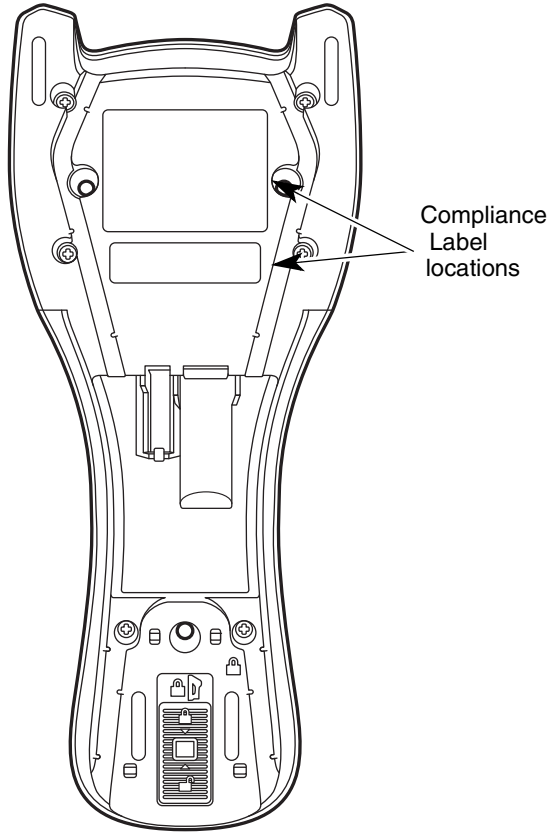



Table of Contents

Chapter 1 - Getting Started

| | |
|--|------|
| About This Manual | 1-1 |
| Unpacking Your Device | 1-1 |
| Connecting the Device | 1-1 |
| Connecting with USB | 1-1 |
| Connecting with Keyboard Wedge | 1-3 |
| Connecting with RS232 Serial Port | 1-5 |
| Connecting with RS485 | 1-7 |
| Mounting a CCB01-010BT Charge Base | 1-8 |
| Mounting a CCB02-100BT Base | 1-8 |
| Reading Techniques | 1-10 |
| Menu Bar Code Security Settings | 1-10 |
| Setting Custom Defaults | 1-11 |
| Resetting the Custom Defaults | 1-11 |

Chapter 2 - Programming the Interface

| | |
|--|------|
| Introduction | 2-1 |
| Programming the Interface - Plug and Play | 2-1 |
| Keyboard Wedge | 2-1 |
| Laptop Direct Connect | 2-1 |
| RS232 Serial Port | 2-1 |
| RS485 | 2-2 |
| RS485 Packet Mode | 2-2 |
| USB IBM SurePos | 2-3 |
| USB PC or Macintosh Keyboard | 2-3 |
| USB HID | 2-4 |
| USB Serial | 2-4 |
| CTS/RTS Emulation | 2-4 |
| ACK/NAK Mode | 2-4 |
| Remote MasterMind™ for USB | 2-4 |
| Verifone® Ruby Terminal Default Settings | 2-5 |
| Gilbarco® Terminal Default Settings | 2-5 |
| Honeywell Bioptic Aux Port Configuration | 2-5 |
| Datalogic™ Magellan® Aux Port Configuration | 2-6 |
| NCR Bioptic Aux Port Configuration | 2-6 |
| Wincor Nixdorf Terminal Default Settings | 2-6 |
| Wincor Nixdorf Beetle™ Terminal Default Settings | 2-6 |
| Keyboard Country Layout | 2-7 |
| Keyboard Style | 2-14 |
| Keyboard Conversion | 2-15 |
| Control Character Output | 2-16 |
| Keyboard Modifiers | 2-16 |

| | |
|---|------|
| RS232 Modifiers | 2-18 |
| RS232 Baud Rate | 2-18 |
| RS232 Word Length: Data Bits, Stop Bits, and Parity | 2-19 |
| RS232 Receiver Time-Out..... | 2-20 |
| RS232 Handshaking..... | 2-20 |
| RS232 Timeout..... | 2-20 |
| XON/XOFF | 2-21 |
| ACK/NAK | 2-21 |
| Scanner to Bioptic Communication | 2-21 |
| Scanner-Bioptic Packet Mode | 2-21 |
| Scanner-Bioptic ACK/NAK Mode..... | 2-22 |
| Scanner-Bioptic ACK/NAK Timeout..... | 2-22 |

Chapter 3 - Cordless System Operation

| | |
|--|-----|
| How the Cordless Charge Base/Access Point Works | 3-1 |
| Linking the Scanner to a Charge Base | 3-1 |
| Linking the Scanner to an Access Point | 3-1 |
| Replacing a Linked Scanner..... | 3-2 |
| Communication Between the Cordless System and the Host..... | 3-2 |
| Programming the Scanner and Base or Access Point | 3-3 |
| RF (Radio Frequency) Module Operation | 3-3 |
| System Conditions..... | 3-3 |
| Linking Process | 3-3 |
| Scanner Is Out of Range | 3-3 |
| Scanner Is Moved Back Into Range | 3-3 |
| Out of Range and Back into Range with Batch Mode On..... | 3-3 |
| Page Button..... | 3-3 |
| About the Battery | 3-4 |
| Charging Information | 3-4 |
| Battery Recommendations | 3-4 |
| Proper Disposal of the Battery..... | 3-4 |
| Beeper and LED Sequences and Meaning | 3-5 |
| Scanner LED Sequences and Meaning..... | 3-5 |
| Base/Access Point LED Sequences and Meaning | 3-5 |
| Base Power Communication Indicator..... | 3-5 |
| Reset Scanner..... | 3-6 |
| Scanning While in Base Cradle | 3-6 |
| Base Charging Modes | 3-6 |
| Paging | 3-7 |
| Paging Mode..... | 3-7 |
| Paging Pitch..... | 3-7 |
| Error Indicators | 3-8 |
| Beeper Pitch - Base Error..... | 3-8 |
| Number of Beeps - Base Error | 3-8 |
| Scanner Report | 3-8 |
| Scanner Address | 3-9 |
| Base or Access Point Address | 3-9 |

| | |
|---|------|
| Scanner Modes | 3-9 |
| Charge Only Mode..... | 3-9 |
| Linked Modes | 3-9 |
| Unlinking the Scanner | 3-10 |
| Override Locked Scanner..... | 3-10 |
| Out-of-Range Alarm | 3-10 |
| Alarm Sound Type..... | 3-11 |
| Scanner Power Time-Out Timer..... | 3-11 |
| Flexible Power Management..... | 3-12 |
| Batch Mode | 3-13 |
| Batch Mode Beep..... | 3-14 |
| Batch Mode Storage..... | 3-14 |
| Batch Mode Quantity | 3-15 |
| Batch Mode Output Order..... | 3-16 |
| Total Records | 3-17 |
| Delete Last Code | 3-17 |
| Clear All Codes..... | 3-17 |
| Transmit Records to Host..... | 3-17 |
| Batch Mode Transmit Delay | 3-17 |
| Multiple Scanner Operation | 3-18 |
| Scanner Name..... | 3-18 |
| Application Work Groups..... | 3-19 |
| Application Work Group Selection | 3-20 |
| Resetting the Factory Defaults: All Application Work Groups | 3-20 |
| Resetting the Custom Defaults: All Application Work Groups | 3-21 |
| Using the Scanner with Bluetooth Devices..... | 3-21 |
| Bluetooth HID Keyboard Connect..... | 3-21 |
| Virtual Keyboard | 3-22 |
| Bluetooth HID Keyboard Disconnect | 3-23 |
| Bluetooth Serial Port - PCs/Laptops | 3-23 |
| PDAs/Mobility Systems Devices..... | 3-23 |
| Changing the Scanner's Bluetooth PIN Code..... | 3-23 |
| Minimizing Bluetooth/ISM Band Network Activity | 3-23 |
| Auto Reconnect Mode | 3-24 |
| Maximum Link Attempts | 3-24 |
| Relink Time-Out..... | 3-25 |
| Bluetooth/ISM Network Activity Examples..... | 3-25 |
| Host Acknowledgment..... | 3-26 |

Chapter 4 - Input/Output Settings

| | |
|----------------------------|-----|
| Power Up Beeper | 4-1 |
| Beep on BEL Character..... | 4-1 |
| Trigger Click | 4-2 |

| | |
|--|------|
| Good Read and Error Indicators..... | 4-2 |
| Beeper – Good Read..... | 4-2 |
| Beeper Volume – Good Read..... | 4-2 |
| Beeper Pitch – Good Read..... | 4-3 |
| Vibrate – Good Read..... | 4-3 |
| Beeper Pitch – Error..... | 4-4 |
| Beeper Duration – Good Read..... | 4-4 |
| LED – Good Read..... | 4-4 |
| Number of Beeps – Good Read..... | 4-5 |
| Number of Beeps – Error..... | 4-5 |
| Beeper Volume Max..... | 4-5 |
| Good Read Delay..... | 4-5 |
| User-Specified Good Read Delay..... | 4-6 |
| Manual Trigger Modes..... | 4-6 |
| LED Illumination - Manual Trigger..... | 4-6 |
| Serial Trigger Mode..... | 4-7 |
| Read Time-Out..... | 4-7 |
| Presentation Mode..... | 4-7 |
| LED Illumination - Presentation Mode..... | 4-8 |
| Presentation LED Behavior after Decode..... | 4-8 |
| Presentation Sensitivity..... | 4-8 |
| Presentation Centering..... | 4-8 |
| In-Stand Sensor Mode..... | 4-10 |
| CodeGate®..... | 4-10 |
| Streaming Presentation™ Mode..... | 4-11 |
| Streaming Presentation In-Stand Programming..... | 4-11 |
| Mobile Phone Read Mode..... | 4-11 |
| Hands Free Time-Out..... | 4-12 |
| Reread Delay..... | 4-12 |
| User-Specified Reread Delay..... | 4-12 |
| 2D Reread Delay..... | 4-13 |
| Character Activation Mode..... | 4-13 |
| Activation Character..... | 4-14 |
| End Character Activation After Good Read..... | 4-14 |
| Character Activation Timeout..... | 4-14 |
| Character Deactivation Mode..... | 4-14 |
| Deactivation Character..... | 4-15 |
| Illumination Lights..... | 4-15 |
| Aimer Delay..... | 4-15 |
| User-Specified Aimer Delay..... | 4-16 |
| Aimer Mode..... | 4-16 |
| Centering..... | 4-16 |
| Preferred Symbology..... | 4-18 |
| High Priority Symbology..... | 4-18 |
| Low Priority Symbology..... | 4-18 |
| Preferred Symbology Time-out..... | 4-19 |
| Preferred Symbology Default..... | 4-19 |

| | |
|-----------------------------------|------|
| Output Sequence Overview..... | 4-19 |
| Output Sequence Editor | 4-19 |
| To Add an Output Sequence | 4-19 |
| Other Programming Selections..... | 4-20 |
| Output Sequence Editor | 4-21 |
| Partial Sequence | 4-21 |
| Require Output Sequence | 4-21 |
| Multiple Symbols | 4-22 |
| No Read | 4-22 |
| Video Reverse | 4-23 |
| Working Orientation..... | 4-23 |

Chapter 5 - Data Editing

| | |
|--|-----|
| Prefix/Suffix Overview | 5-1 |
| To Add a Prefix or Suffix:..... | 5-1 |
| To Clear One or All Prefixes or Suffixes | 5-2 |
| To Add a Carriage Return Suffix to All Symbologies | 5-2 |
| Prefix Selections..... | 5-2 |
| Suffix Selections | 5-2 |
| Function Code Transmit | 5-3 |
| Intercharacter, Interfunction, and Intermesssage Delays..... | 5-3 |
| Intercharacter Delay | 5-3 |
| User Specified Intercharacter Delay | 5-3 |
| Interfunction Delay..... | 5-4 |
| Intermesssage Delay..... | 5-4 |

Chapter 6 - Data Formatting

| | |
|--|------|
| Data Format Editor Introduction | 6-1 |
| Add a Data Format | 6-1 |
| Other Programming Selections..... | 6-2 |
| Terminal ID Table | 6-3 |
| Data Format Editor Commands..... | 6-3 |
| Move Commands..... | 6-6 |
| Search Commands..... | 6-7 |
| Miscellaneous Commands..... | 6-9 |
| Data Formatter | 6-12 |
| Data Format Non-Match Error Tone | 6-13 |
| Primary/Alternate Data Formats | 6-13 |
| Single Scan Data Format Change | 6-13 |

Chapter 7 - Symbologies

| | |
|----------------------------------|-----|
| All Symbologies | 7-1 |
| Message Length Description | 7-1 |
| Codabar | 7-2 |
| Codabar Concatenation..... | 7-3 |

| | |
|--|------|
| Code 39 | 7-4 |
| Code 32 Pharmaceutical (PARAF) | 7-5 |
| Full ASCII..... | 7-6 |
| Code 39 Code Page | 7-6 |
| Interleaved 2 of 5..... | 7-7 |
| NEC 2 of 5 | 7-8 |
| Code 93 | 7-9 |
| Code 93 Code Page | 7-10 |
| Straight 2 of 5 Industrial (three-bar start/stop)..... | 7-11 |
| Straight 2 of 5 IATA (two-bar start/stop) | 7-12 |
| Matrix 2 of 5..... | 7-13 |
| Code 11 | 7-14 |
| Code 128..... | 7-15 |
| ISBT 128 Concatenation..... | 7-15 |
| Code 128 Code Page | 7-16 |
| GS1-128 | 7-17 |
| Telepen..... | 7-18 |
| UPC-A | 7-19 |
| UPC-A/EAN-13 with Extended Coupon Code | 7-21 |
| Coupon GS1 DataBar Output..... | 7-21 |
| UPC-E0 | 7-22 |
| UPC-E1 | 7-24 |
| EAN/JAN-13 | 7-24 |
| Convert UPC-A to EAN-13 | 7-24 |
| ISBN Translate | 7-26 |
| EAN/JAN-8 | 7-27 |
| MSI | 7-29 |
| GS1 DataBar Omnidirectional | 7-31 |
| GS1 DataBar Limited..... | 7-31 |
| GS1 DataBar Expanded | 7-32 |
| Trioptic Code | 7-32 |
| Codablock A | 7-33 |
| Codablock F | 7-34 |
| PDF417 | 7-35 |
| MacroPDF417 | 7-35 |
| MicroPDF417..... | 7-36 |
| GS1 Composite Codes..... | 7-36 |
| UPC/EAN Version..... | 7-37 |
| GS1 Emulation | 7-37 |
| TCIF Linked Code 39 (TLC39) | 7-38 |
| QR Code..... | 7-38 |
| QR Code Page | 7-39 |
| Data Matrix | 7-40 |
| Data Matrix Code Page | 7-40 |
| MaxiCode | 7-41 |
| Aztec Code | 7-42 |
| Aztec Code Page..... | 7-42 |
| Chinese Sensible (Han Xin) Code..... | 7-43 |

| | |
|------------------------------------|------|
| Postal Codes - 2D | 7-44 |
| Single 2D Postal Codes:..... | 7-44 |
| Combination 2D Postal Codes:..... | 7-45 |
| Postal Codes - Linear | 7-48 |
| China Post (Hong Kong 2 of 5)..... | 7-48 |
| Korea Post..... | 7-49 |

Chapter 8 - Imaging Commands

| | |
|--|------|
| Single-Use Basis | 8-1 |
| Command Syntax..... | 8-1 |
| Image Snap - IMGSNP | 8-1 |
| IMGSNP Modifiers..... | 8-1 |
| Image Ship - IMGSHIP | 8-3 |
| IMGSHIP Modifiers..... | 8-4 |
| Intelligent Signature Capture - IMGBOX | 8-10 |
| Signature Capture Optimize | 8-10 |
| IMGBOX Modifiers..... | 8-11 |
| RF Default Imaging Device..... | 8-14 |

Chapter 9 - Interface Keys

| | |
|--------------------------------------|-----|
| Keyboard Function Relationships..... | 9-1 |
| Supported Interface Keys | 9-3 |

Chapter 10 - Utilities

| | |
|---|------|
| To Add a Test Code I.D. Prefix to All Symbolologies | 10-1 |
| Show Decoder Revision | 10-1 |
| Show Scan Driver Revision | 10-1 |
| Show Software Revision..... | 10-1 |
| Show Data Format..... | 10-1 |
| Test Menu..... | 10-2 |
| TotalFreedom | 10-2 |
| Application Plug-Ins (Apps) | 10-2 |
| EZConfig-Scanning Introduction..... | 10-3 |
| Installing EZConfig-Scanning from the Web..... | 10-3 |
| Resetting the Factory Defaults | 10-4 |

Chapter 11 - Serial Programming Commands

| | |
|------------------------------------|------|
| Conventions..... | 11-1 |
| Menu Command Syntax | 11-1 |
| Query Commands | 11-1 |
| Responses..... | 11-2 |
| Trigger Commands..... | 11-3 |
| Resetting the Custom Defaults..... | 11-3 |
| Menu Commands | 11-4 |

Chapter 12 - Product Specifications

| | |
|---|-------|
| Xenon 1900/1910 Corded Scanner Product Specifications | 12-1 |
| Xenon 1902/1912 Cordless Scanner Product Specifications | 12-1 |
| Granit 1910i Industrial Corded Scanner Product Specifications..... | 12-2 |
| Granit 1911i Industrial Cordless Scanner Product Specifications | 12-3 |
| CCB01-010BT Charge Base Product Specifications..... | 12-4 |
| CCB02-100BT Industrial Charge Base Product Specifications | 12-5 |
| Depth of Field Charts..... | 12-6 |
| Xenon B&W Scanner Typical Performance..... | 12-6 |
| Xenon B&W Scanner Guaranteed Performance | 12-6 |
| Xenon Color Scanner (Model COL) Typical Performance..... | 12-7 |
| Xenon Color Scanner (Model COL) Guaranteed Performance | 12-7 |
| Granit Scanner Typical Performance | 12-7 |
| Granit Scanner Guaranteed Performance | 12-8 |
| Standard Connector Pinouts | 12-9 |
| Keyboard Wedge | 12-9 |
| Serial Output..... | 12-9 |
| RS485 Output..... | 12-9 |
| USB | 12-10 |

Chapter 13 - Maintenance

| | |
|--|------|
| Repairs | 13-1 |
| Maintenance | 13-1 |
| Cleaning the Scanner | 13-1 |
| Cleaning the Window..... | 13-1 |
| Health Care Housing | 13-1 |
| Inspecting Cords and Connectors | 13-2 |
| Replacing Cables in Corded Scanners..... | 13-2 |
| Replacing a Xenon Interface Cable | 13-2 |
| Replacing a Granit Interface Cable..... | 13-2 |
| Replacing Cables and Batteries in Cordless Systems | 13-2 |
| Replacing an Interface Cable in a Base | 13-2 |
| Changing a Xenon Scanner Battery | 13-3 |
| Changing a Granit Scanner Battery..... | 13-3 |
| Troubleshooting a Corded Scanner..... | 13-3 |
| Troubleshooting a Cordless System..... | 13-4 |
| Troubleshooting a Base..... | 13-4 |
| Troubleshooting a Cordless Scanner | 13-4 |

Chapter 14 - Customer Support

| | |
|---------------------------------|------|
| Technical Assistance..... | 14-1 |
| Product Service and Repair..... | 14-1 |

Appendix A - Reference Charts

| | |
|--------------------------|-----|
| Symbology Charts | A-1 |
| Linear Symbologies | A-1 |
| 2D Symbologies..... | A-2 |
| Postal Symbologies | A-2 |

| | |
|---|------|
| ASCII Conversion Chart (Code Page 1252)..... | A-3 |
| Lower ASCII Reference Table..... | A-4 |
| ISO 2022/ISO 646 Character Replacements | A-7 |
| Unicode Key Maps | A-10 |

Sample Symbols

Programming Chart



Getting Started

About This Manual

This User's Guide provides installation and programming instructions for the Xenon™ 1900 and 1910 corded area-imaging scanners, the Xenon 1902 and 1912 cordless area-imaging scanners, and the Granit 1910i corded and 1911i cordless industrial scanners. Product specifications, dimensions, warranty, and customer support information are also included.

Honeywell bar code scanners are factory programmed for the most common terminal and communications settings. If you need to change these settings, programming is accomplished by scanning the bar codes in this guide.

An asterisk (*) next to an option indicates the default setting.

Unpacking Your Device

After you open the shipping carton containing the product, take the following steps:

- Check for damage during shipment. Report damage immediately to the carrier who delivered the carton.
- Make sure the items in the carton match your order.
- Save the shipping container for later storage or shipping.

Connecting the Device

Connecting with USB

A scanner or a cordless base can be connected to the USB port of a computer.

1. Connect the appropriate interface cable to the device first, then to the computer.

Corded Xenon Scanner USB Connection:

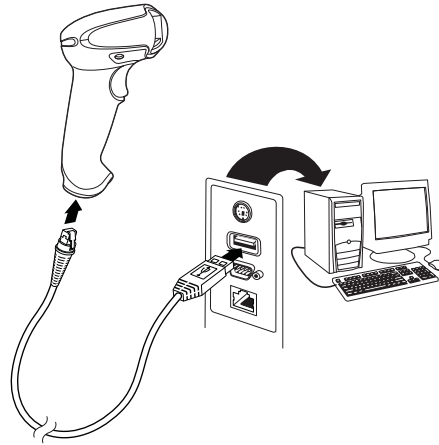

**Corded Granit Scanner
USB Connection:**

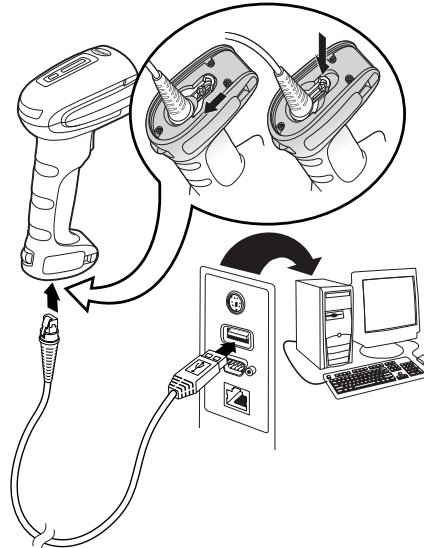

2. If you are connecting a Granit scanner, make sure the cable is pushed tightly into the scanner. Loosen the locking plate and slide it over the base of the cable connector to lock the cable in place. Tighten the screw.

**CCB01-010BT Base
USB Connection:**

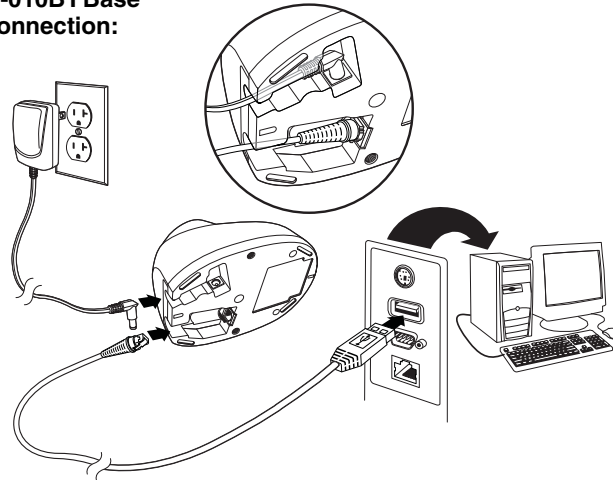

**CCB02-100BT Base
USB Connection:**

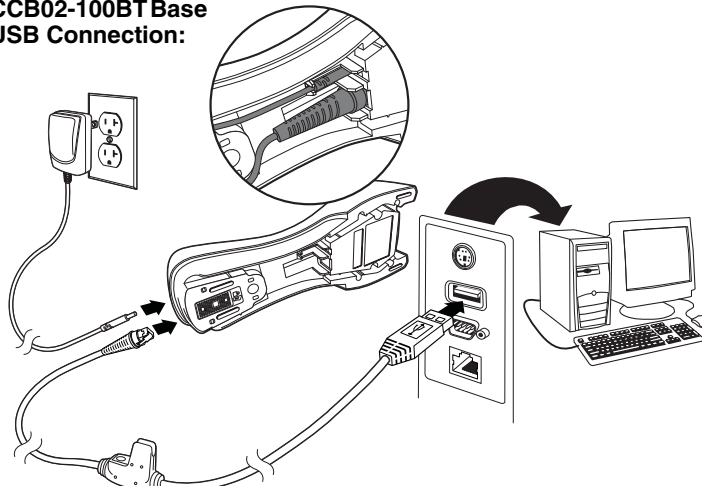

Note: The power supply must be ordered separately, if needed.

3. If you are connecting a CCB01-010BT Base, make sure the cables are secured in the wireways in the bottom of the cordless base and the base sits flat on a horizontal surface. If you are connecting a CCB02-100BT Base, see [Mounting a CCB02-100BT Base](#) on page 1-8.
4. The scanner beeps.
5. Verify the scanner or cordless base operation by scanning a bar code from the [Sample Symbols](#) in the back of this manual.

The unit defaults to a USB PC Keyboard. Refer to [page 2-3](#) for other USB terminal settings.

For additional USB programming and technical information, refer to "USB Application Note," available at www.honeywellaidc.com.

Connecting with Keyboard Wedge

A scanner or cordless base can be connected between the keyboard and PC as a "keyboard wedge," where the scanner provides data output that is similar to keyboard entries. The following is an example of a keyboard wedge connection:

1. Turn off power and disconnect the keyboard cable from the back of the terminal/computer.
2. Connect the appropriate interface cable to the device and to the terminal/computer.

Corded Xenon Scanner Keyboard Wedge Connection:

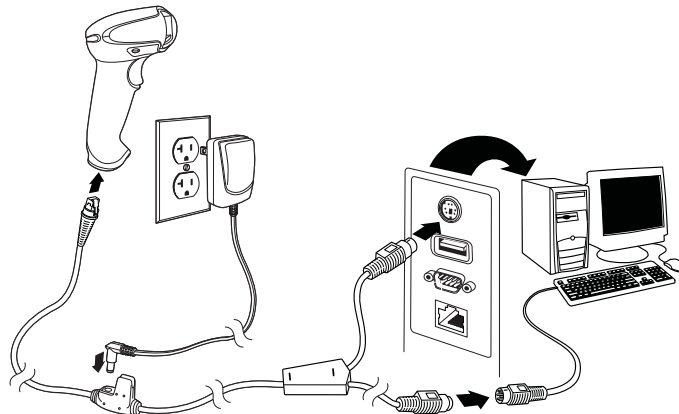

Corded Granit Scanner Keyboard Wedge Connection:

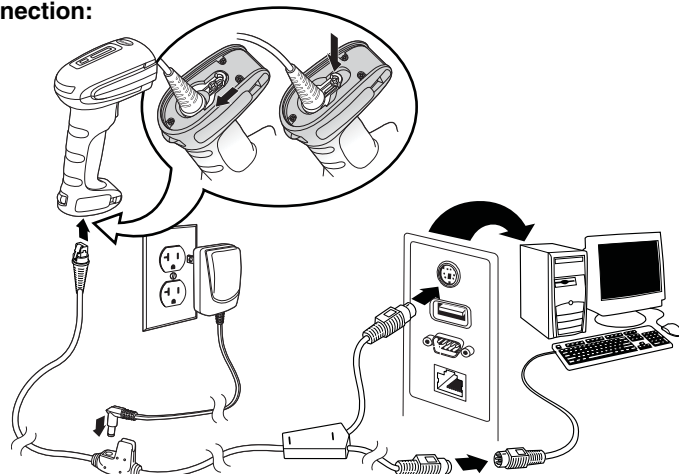

3. If you are connecting a Granit scanner, make sure the cable is pushed tightly into the scanner. Loosen the locking plate and slide it over the base of the cable connector to lock the cable in place. Tighten the screw.

**CCB01-010BT Base Keyboard
Wedge Connection:**

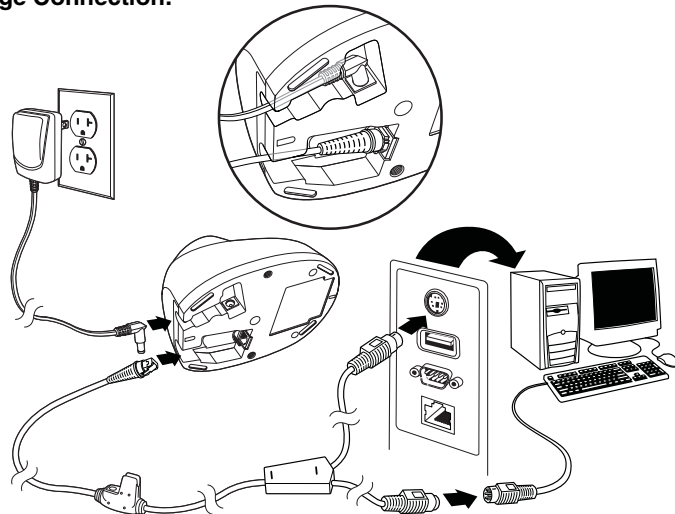

**CCB02-100BT Base Keyboard
Wedge Connection:**

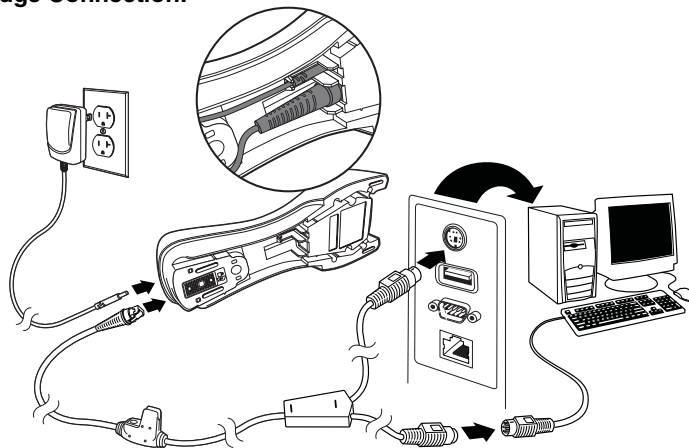

Note: The power supply must be ordered separately, if needed.

4. If you are connecting a CCB01-010BT Base, make sure the cables are secured in the wireways in the bottom of the cordless base and the base sits flat on a horizontal surface. If you are connecting a CCB02-100BT Base, see [Mounting a CCB02-100BT Base](#) on page 1-8.
5. Turn the terminal/computer power back on. The scanner beeps.
6. Verify the scanner or cordless base operation by scanning a bar code from the [Sample Symbols](#) in the back of this manual. The scanner beeps once. If using a Granit scanner, it also vibrates.

The unit defaults to an IBM PC AT and compatibles keyboard wedge interface with a USA keyboard. A carriage return (CR) suffix is added to bar code data.

Connecting with RS232 Serial Port

1. Turn off power to the terminal/computer.
2. Connect the appropriate interface cable to the scanner.

Note: For the scanner or cordless base to work properly, you must have the correct cable for your type of terminal/computer.

Corded Xenon Scanner RS232 Serial Port Connection:

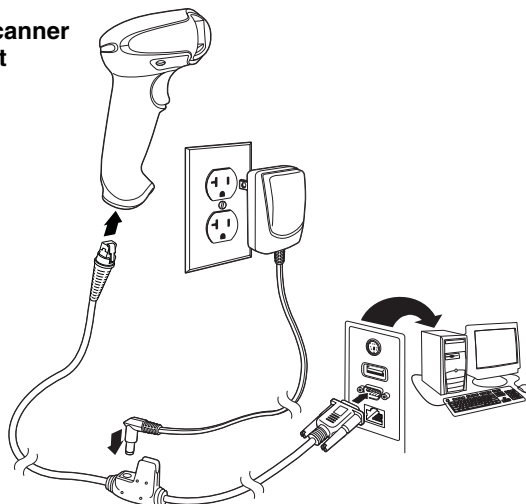

Corded Granit Scanner RS232 Serial Port Connection:

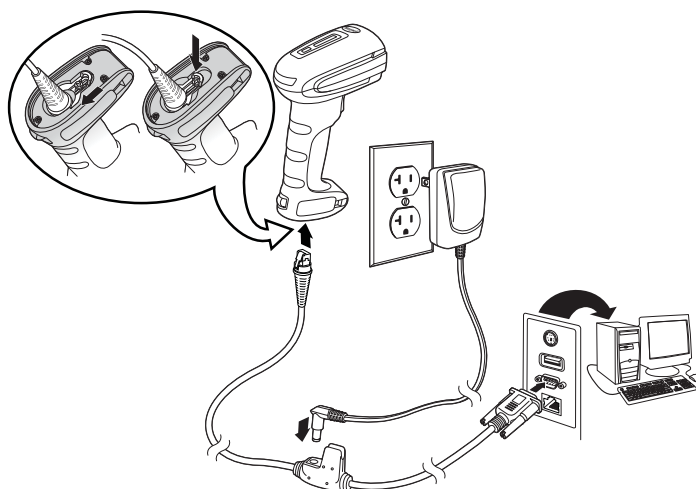

-
3. If you are connecting a Granit scanner, make sure the cable is pushed tightly into the scanner. Loosen the locking plate and slide it over the base of the cable connector to lock the cable in place. Tighten the screw.

**CCB01-010BT Base
RS232 Serial Port Connection:**

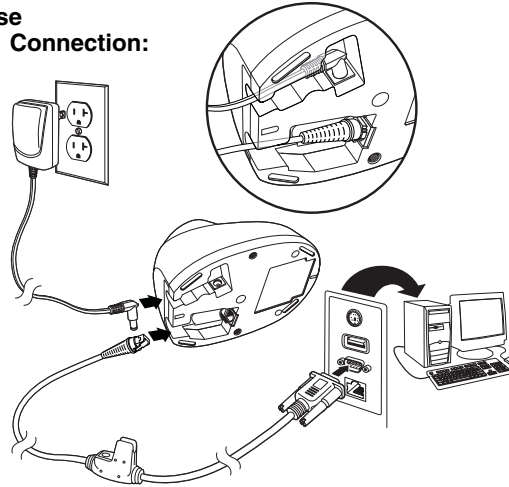

**CCB02-100BT Base
RS232 Serial Port Connection:**

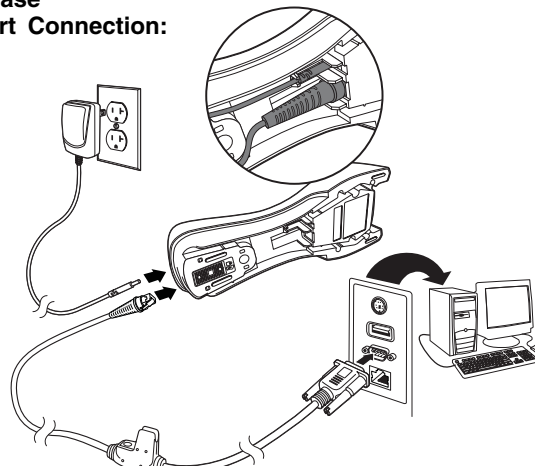

Note: The power supply must be ordered separately, if needed.

4. If you are connecting a CCB01-010BT Base, make sure the cables are secured in the wireways in the bottom of the cordless base and the base sits flat on a horizontal surface. If you are connecting a CCB02-100BT Base, see [Mounting a CCB02-100BT Base](#) on page 1-8.
5. Plug the serial connector into the serial port on your computer. Tighten the two screws to secure the connector to the port.
6. Once the scanner or cordless base has been fully connected, power up the computer.

This interface programs 115,200 baud, 8 data bits, no parity, and 1 stop bit.

Connecting with RS485

A Xenon scanner or cordless base can be connected for an IBM POS terminal interface. (This interface is not available in the Gravit devices.)

1. Connect the appropriate interface cable to the device, then to the computer.

Corded Xenon Scanner RS485 Connection:

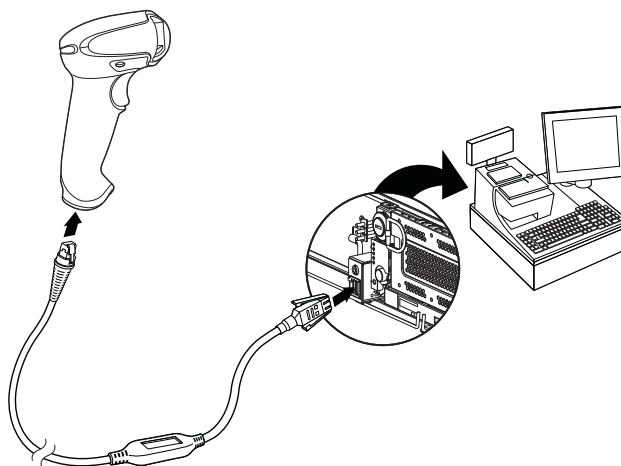

CCB01-010BT Base RS485 Connection:

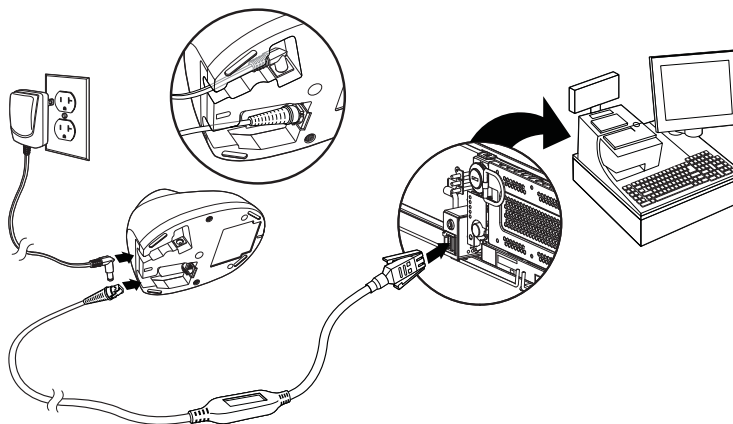

Note: The power supply must be ordered separately, if needed.

2. Make sure the cables are secured in the wireways in the bottom of the cordless base and the base sits flat on a horizontal surface.
3. Turn the terminal/computer power back on. The scanner beeps.
4. Verify the scanner or cordless base operation by scanning a bar code from the [Sample Symbols](#) in the back of this manual. The scanner beeps once. If using a Gravit scanner, it also vibrates.

For further RS485 settings, refer to [RS485](#), page 2-2.

Mounting a CCB01-010BT Charge Base

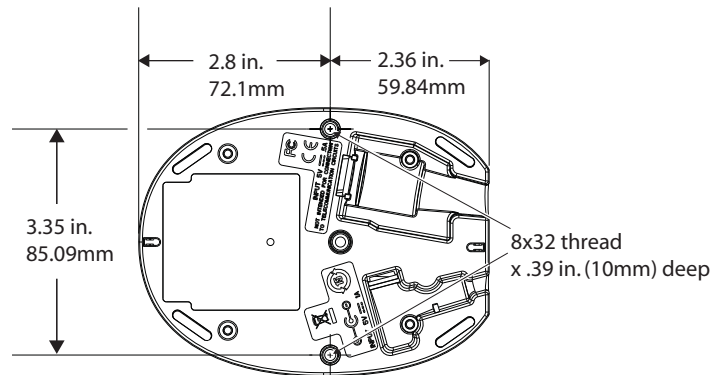

Mounting a CCB02-100BT Base

The CCB02-100BT Base can be mounted on either a horizontal or vertical surface. The cables can be routed through either the top or the bottom of the base.

The cables can be routed down through the bottom of the base, securing the cables in the wireways.

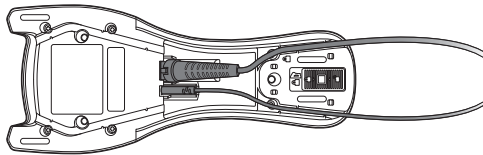

The cables can also be routed up through the top of the base, crossing them over and securing the cables in the wireways.

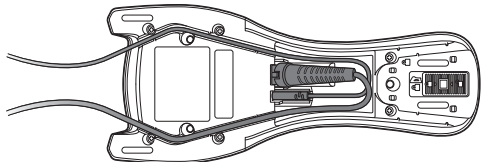

When routing the cables up through the top of the base, be sure to cross the cables over before placing in the wireways. If not, too much strain is placed on the cable connectors.

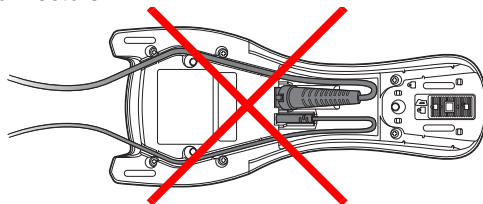

When mounted on a vertical surface, a locking system is used to secure the scanner when it is in the stand. When mounted on a horizontal surface, the locking mechanism should be set to unlocked (pushed up). When mounted on a vertical surface, the locking mechanism should be set to locked (pushed down).

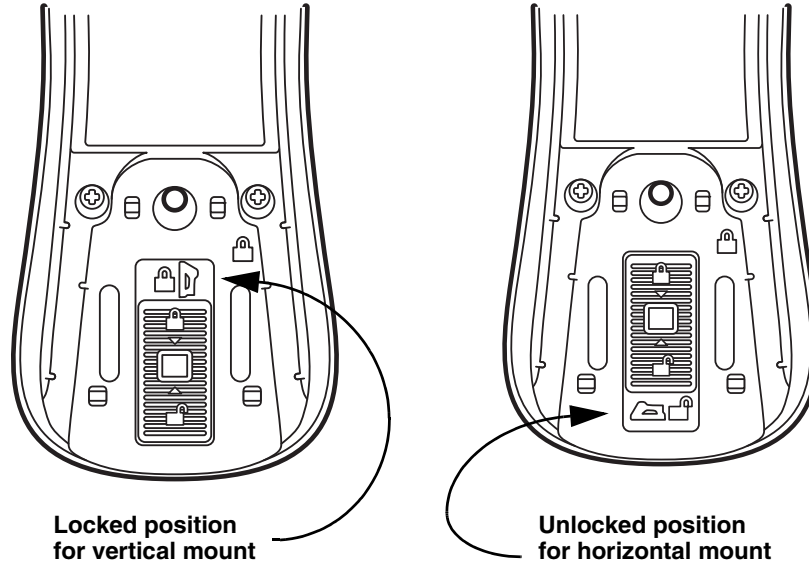

Use 30mm screws, appropriate for the mounting surface material, to mount the base securely.

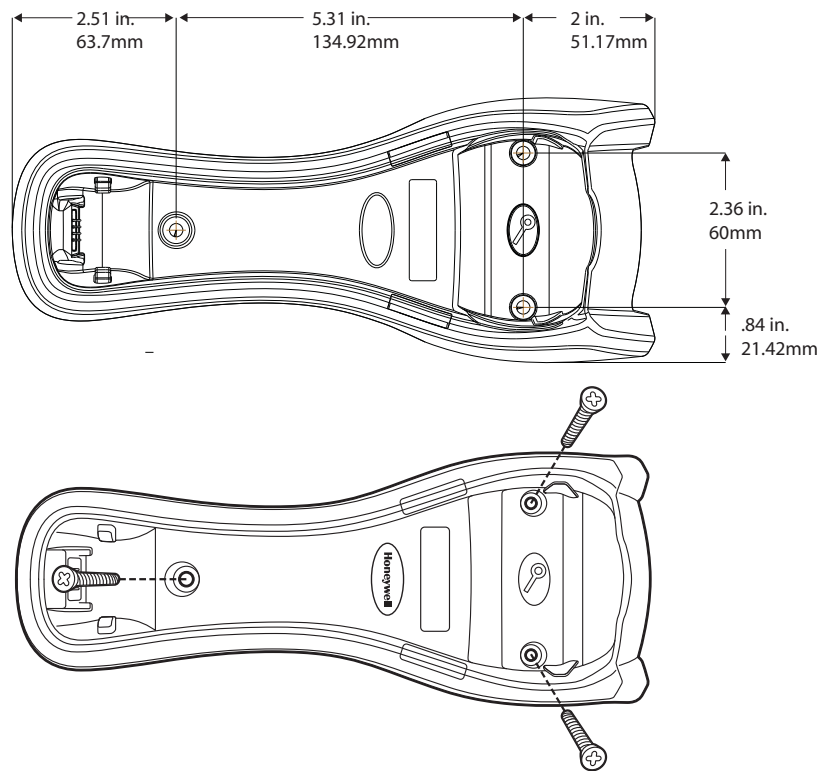

Reading Techniques

The Xenon 1900/1902 scanners have a view finder that projects a bright red aiming beam that corresponds to the scanner's horizontal field of view. The Xenon 1910/1912 and Granit 1910i/1911i scanners have an aiming pattern. The aiming beam or pattern should be centered over the bar code, but it can be positioned in any direction for a good read.

**Linear bar codes
with aiming beam**

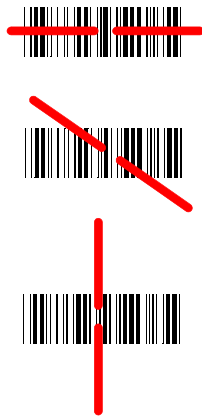

**Linear bar codes
with aiming pattern**

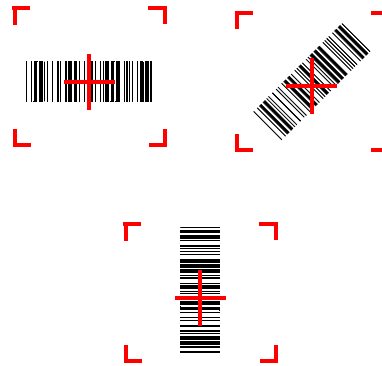

**2D Matrix symbol
with aiming beam**

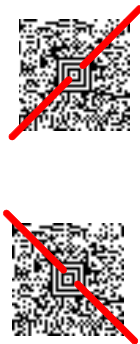

**2D Matrix symbol
with aiming pattern**

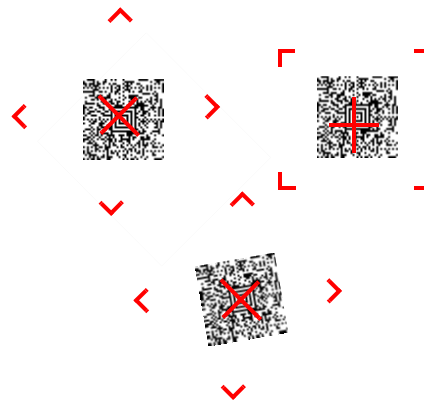

The aiming beam or pattern is smaller when the scanner is closer to the code and larger when it is farther from the code. Symbologies with smaller bars or elements (mil size) should be read closer to the unit. Symbologies with larger bars or elements (mil size) should be read farther from the unit. To read single or multiple symbols (on a page or on an object), hold the scanner at an appropriate distance from the target, pull the trigger, and center the aiming beam or pattern on the symbol. If the code being scanned is highly reflective (e.g., laminated), it may be necessary to tilt the code up 15° to 18° to prevent unwanted reflection.

Menu Bar Code Security Settings

Honeywell scanners are programmed by scanning menu bar codes or by sending serial commands to the scanner. If you want to restrict the ability to scan menu codes, you can use the Menu Bar Code Security settings. Please contact the nearest technical support office (see [Technical Assistance](#) on page 14-1) for further information.

Setting Custom Defaults

You have the ability to create a set of menu commands as your own, custom defaults. To do so, scan the **Set Custom Defaults** bar code below before scanning the menu commands for your custom defaults. If a menu command requires scanning numeric codes from the back cover, then a **Save** code, that entire sequence will be saved to your custom defaults. When you have entered all the commands you want to save for your custom defaults, scan the **Save Custom Defaults** bar code.



MNUCDP.
Set Custom Defaults



MNUCDS.
Save Custom Defaults

*Note: When using a cordless system, the Custom Defaults settings apply to all workgroups. Scanning the **Save Defaults** bar code also causes both the scanner and the base or Access Point to perform a reset and become unlinked. The scanner must be placed in its base to re-establish the link before any setup codes are entered. If using an Access Point, the linking bar code must be scanned. See [Cordless System Operation](#) beginning on page 3-1 for additional information.*

You may have a series of custom settings and want to correct a single setting. To do so, just scan the new setting to overwrite the old one. For example, if you had previously saved the setting for Beeper Volume at Low to your custom defaults, and decide you want the beeper volume set to High, just scan the **Set Custom Defaults** bar code, then scan the Beeper Volume High menu code, and then **Save Custom Defaults**. The rest of the custom defaults will remain, but the beeper volume setting will be updated.

Resetting the Custom Defaults

If you want the custom default settings restored to your scanner, scan the **Activate Custom Defaults** bar code below. This is the recommended default bar code for most users. It resets the scanner to the custom default settings. If there are no custom defaults, it will reset the scanner to the factory default settings. Any settings that have not been specified through the custom defaults will be defaulted to the factory default settings.



DEFAULT.
Activate Custom Defaults

Note: If using a cordless system, scanning this bar code also causes both the scanner and the base or Access Point to perform a reset and become unlinked. The scanner must be placed in its base to re-establish the link. If using an Access Point, the linking bar code must be scanned. See [Cordless System Operation](#) beginning on page 3-1 for additional information.



Programming the Interface

Introduction

This chapter describes how to program your system for the desired interface.

Programming the Interface - Plug and Play

Plug and Play bar codes provide instant scanner set up for commonly used interfaces.

Note: After you scan one of the codes, power cycle the host terminal to have the interface in effect.

Keyboard Wedge

If you want your system programmed for an IBM PC AT and compatibles keyboard wedge interface with a USA keyboard, scan the bar code below. Keyboard wedge is the default interface.

Note: The following bar code also programs a carriage return (CR) suffix.



Laptop Direct Connect

For most laptops, scanning the **Laptop Direct Connect** bar code allows operation of the scanner in parallel with the integral keyboard. The following **Laptop Direct Connect** bar code also programs a carriage return (CR) suffix and turns on Emulate External Keyboard ([page 2-15](#)).



RS232 Serial Port

The **RS232 Interface** bar code is used when connecting to the serial port of a PC or terminal. The following **RS232 Interface** bar code also programs a carriage return (CR) and a line feed (LF) suffix, baud rate, and data format as indicated below. It also changes the trigger mode to manual.

| Option | Setting |
|-------------|--|
| Baud Rate | 115,200 bps |
| Data Format | 8 data bits, no parity bit, 1 stop bit |



RS485

Scan one of the following “Plug and Play” codes to program the scanner for an IBM POS terminal interface.

*Note: This interface is not supported in Granit devices.
After scanning one of these codes, you must power cycle the cash register.*



IBM Port 5B Interface



**IBM Port 9B
HHBCR-1 Interface**



IBM Port 17 Interface



**IBM Port 9B
HHBCR-2 Interface**

Each bar code above also programs the following suffixes for each symbology:

| Symbology | Suffix | Symbology | Suffix |
|-----------|--------|--------------------|----------|
| EAN 8 | 0C | Code 39 | 00 0A 0B |
| EAN 13 | 16 | Interleaved 2 of 5 | 00 0D 0B |
| UPC A | 0D | Code 128 * | 00 0A 0B |
| UPC E | 0A | Code 128 ** | 00 18 0B |
| | | MaxiCode | 00 2F 0B |

* Suffixes programmed for Code 128 with IBM 4683 Port 5B, IBM 4683 Port 9B HHBCR-1, and IBM 4683 Port 17 Interfaces

** Suffixes programmed for Code 128 with IBM 4683 Port 9 HHBCR-2 Interface

RS485 Packet Mode

The following selection allows you to break up large bar code data into smaller packets on an IBM POS terminal. To break up large bar codes into small packets, scan the Packet Mode On bar code below. Scan the Packet Mode Off bar code if you want large bar code data to be sent to the host in a single chunk. *Default = Packet Mode Off.*



*** Packet Mode Off**



**RTLPDF1.
Packet Mode On**

RS485 Packet Length

If you are using Packet mode, you can specify the size of the data “packet” that is sent to the host. Scan the **Packet Length** bar code, then then the packet size (from 20 - 256) from the [Programming Chart](#) inside the back cover of this manual, then **Save**. *Default = 40.*



RTLMP.S.

Packet Length

USB IBM SurePos

Scan one of the following “Plug and Play” codes to program the scanner for an IBM SurePos (USB handheld scanner) or IBM SurePos (USB tabletop scanner) interface.

Note: After scanning one of these codes, you must power cycle the cash register.



PAPSPH.

**USB IBM SurePos
(USB Handheld Scanner)
Interface**



PAPSPT.

**USB IBM SurePos
(USB Tabletop Scanner)
Interface**

Each bar code above also programs the following suffixes for each symbology:

| Symbology | Suffix | Symbology | Suffix |
|-----------|--------|--------------------|----------|
| EAN 8 | 0C | Code 39 | 00 0A 0B |
| EAN 13 | 16 | Interleaved 2 of 5 | 00 0D 0B |
| UPC A | 0D | Code 128 | 00 18 0B |
| UPC E | 0A | Code 39 | 00 0A 0B |

USB PC or Macintosh Keyboard

Scan one of the following codes to program the scanner for USB PC Keyboard or USB Macintosh Keyboard. Scanning these codes also adds a CR suffix.



PAP124.

USB Keyboard (PC)



PAP125.

USB Keyboard (Mac)



TRMUSB134.

USB Japanese Keyboard (PC)

USB HID

Scan the following code to program the scanner for USB HID bar code scanners.



USB Serial

Scan the following code to program the scanner to emulate a regular RS232-based COM Port. If you are using a Microsoft® Windows® PC, you will need to download a driver from the Honeywell website (www.honeywellaidc.com). The driver will use the next available COM Port number. Apple® Macintosh computers recognize the scanner as a USB CDC class device and automatically use a class driver.



Note: No extra configuration (e.g., baud rate) is necessary.

CTS/RTS Emulation



ACK/NAK Mode



Remote MasterMind™ for USB

When using a USB interface, you may wish to configure your scanner to communicate with Remote MasterMind Scanner Management Software (ReM). Scan the **ReM On** bar code to communicate with ReM. To disable this capability, scan **ReM Off**.





REMIFC1.
ReM On

Verifone® Ruby Terminal Default Settings

Scan the following Plug and Play code to program the scanner for a Verifone Ruby terminal. This bar code sets the baud rate to 1200 bps and the data format to 8 data bits, no parity bit, 1 stop bit. It also adds a line feed (LF) suffix and programs the following prefixes for each symbology:

| Symbology | Prefix |
|-----------|--------|
| UPC-A | A |
| UPC-E | A |
| EAN-8 | FF |
| EAN-13 | F |



PAPRBY.
Verifone Ruby Settings

Gilbarco® Terminal Default Settings

Scan the following Plug and Play code to program the scanner for a Gilbarco terminal. This bar code sets the baud rate to 2400 bps and the data format to 7 data bits, even parity, 2 stop bits. It also adds a carriage return (CR) suffix and programs the following prefixes for each symbology:

| Symbology | Prefix |
|-----------|--------|
| UPC-A | A |
| UPC-E | E0 |
| EAN-8 | FF |
| EAN-13 | F |



PAPGLB.
Gilbarco Settings

Honeywell Bioptic Aux Port Configuration

Scan the following Plug and Play code to program the scanner for a Honeywell bioptic scanner auxiliary port configuration. This bar code sets the baud rate to 38400 bps and the data format to 8 data bits, no parity, 1 stop bit.



PAPBIO.
Honeywell Bioptic Settings

Datalogic™ Magellan® Aux Port Configuration

Scan the following Plug and Play code to program the scanner for a Datalogic Magellan auxiliary port configuration. This bar code sets the baud rate to 9600 bps and the data format to 8 data bits, no parity, 1 stop bit.



PAPMAG.

Datalogic Magellan Settings

NCR Bioptic Aux Port Configuration

Scan the following Plug and Play code to program the scanner for an NCR bioptic scanner auxiliary port configuration. The following prefixes are programmed for each symbology:

| Symbology | Prefix | Symbology | Prefix |
|-----------|--------|--------------------------------------|--------|
| UPC-A | A | Interleaved 2 of 5 | b |
| UPC-E | E0 | Code 128 | f |
| | | GS1 DataBar Omnidirectional | r |
| EAN-8 | FF | GS1 DataBar Expanded | r |
| EAN-13 | F | Codabar | N |
| Code 39 | a | Code 32 Pharmaceutical (PARAF) | a |



PAPNCR.

NCR Bioptic Settings

Wincor Nixdorf Terminal Default Settings

Scan the following Plug and Play code to program the scanner for a Wincor Nixdorf terminal. This bar code sets the baud rate to 9600 bps and the data format to 8 data bits, no parity, 1 stop bit.



PAPWNX.

Wincor Nixdorf Terminal Settings

Wincor Nixdorf Beetle™ Terminal Default Settings

Scan the following Plug and Play code to program the scanner for a Wincor Nixdorf Beetle terminal. The following prefixes are programmed for each symbology:

| Symbology | Prefix | Symbology | Prefix |
|-----------|--------|----------------------|--------|
| Code 128 | K | EAN-13 | A |
| Code 93 | L | GS1-128 | P |
| Codabar | N | Interleaved 2 of 5 | I |
| UPC-A | A0 | Plessey | O |
| UPC-E | C | Straight 2 of 5 IATA | H |
| EAN-8 | B | All other bar codes | M |



PAPBTL.

Wincor Nixdorf Beetle Settings

Keyboard Country Layout

Scan the appropriate country code below to program the keyboard layout for your country or language. As a general rule, the following characters are supported, but need special care for countries other than the United States:

@ | \$ # { } [] = / ' \ < > ~

Keyboard Countries



KBDCTY0.

* United States



KBDCTY35.

Albania



KBDCTY81.

Azeri (Cyrillic)



KBDCTY80.

Azeri (Latin)



KBDCTY82.

Belarus



KBDCTY1.

Belgium



KBDCTY33.

Bosnia



KBDCTY16.

Brazil



KBDCTY59.

Brazil (MS)

Keyboard Countries (Continued)



KBDCTY53.
Bulgaria (Latin)



KBDCTY18.
Canada (French)



KBDCTY32.
Croatia



KBDCTY40.
Czech (Programmers)



KBDCTY38.
Czech (QWERTZ)



KBDCTY52.
Bulgaria (Cyrillic)



KBDCTY54.
Canada (French legacy)



KBDCTY55.
Canada (Multilingual)



KBDCTY15.
Czech



KBDCTY39.
Czech (QWERTY)



KBDCTY8.
Denmark

Keyboard Countries (Continued)



KBDCTY11.
Dutch (Netherlands)



KBDCTY83.
Faroese



KBDCTY3.
France



KBDCTY4.
Germany



KBDCTY64.
Greek (220 Latin)



KBDCTY65.
Greek (319 Latin)



KBDCTY41.
Estonia



KBDCTY2.
Finland



KBDCTY84.
Gaelic



KBDCTY17.
Greek



KBDCTY61.
Greek (220)

Keyboard Countries (Continued)



KBDCTY63.
Greek (Latin)



KBDCTY60.
Greek (Polytonic)



KBDCTY50.
Hungarian (101 key)



KBDCTY75.
Iceland



KBDCTY56.
Italian (142)



KBDCTY62.
Greek (319)



KBDCTY66.
Greek (MS)



KBDCTY12.
Hebrew



KBDCTY19.
Hungary



KBDCTY73.
Irish



KBDCTY5.
Italy

Keyboard Countries (Continued)



KBDCTY28.
Japan ASCII



KBDCTY79.
Kyrgyz (Cyrillic)



KBDCTY42.
Latvia



KBDCTY44.
Lithuania



KBDCTY34.
Macedonia



KBDCTY86.
Mongolian (Cyrillic)



KBDCTY78.
Kazakh



KBDCTY14.
Latin America



KBDCTY43.
Latvia (QWERTY)



KBDCTY45.
Lithuania (IBM)



KBDCTY74.
Malta

Keyboard Countries (Continued)



KBDCTY9.
Norway



KBDCTY20.
Poland



KBDCTY57.
Polish (214)



KBDCTY58.
Polish (Programmers)



KBDCTY13.
Portugal



KBDCTY25.
Romania



KBDCTY26.
Russia



KBDCTY67.
Russian (MS)



KBDCTY68.
Russian (Typewriter)



KBDCTY21.
SCS



KBDCTY37.
Serbia (Cyrillic)

Keyboard Countries (Continued)



KBDCTY36.
Serbia (Latin)



KBDCTY49.
Slovakia (QWERTY)



KBDCTY31.
Slovenia



KBDCTY51.
Spanish variation



KBDCTY29.
Switzerland (French)



KBDCTY85.
Tatar



KBDCTY22.
Slovakia



KBDCTY48.
Slovakia (QWERTZ)



KBDCTY10.
Spain



KBDCTY23.
Sweden



KBDCTY6.
Switzerland (German)

Keyboard Countries (Continued)



KBDCTY24.
Turkey Q



KBDCTY7.
United Kingdom



KBDCTY88.
United States (Dvorak left)



KBDCTY30.
United States (International)



KBDCTY27.
Turkey F



KBDCTY76.
Ukrainian



KBDCTY87.
United States (Dvorak)



KBDCTY89.
United States (Dvorak right)



KBDCTY77.
Uzbek (Cyrillic)

Keyboard Style

This programs keyboard styles, such as Caps Lock and Shift Lock. If you have used [Keyboard Conversion](#) settings, they will override any of the following Keyboard Style settings. *Default = Regular.*

Regular is used when you normally have the Caps Lock key off.



KBDSTY0.
* Regular

Caps Lock is used when you normally have the Caps Lock key on.



Shift Lock is used when you normally have the Shift Lock key on (not common to U.S. keyboards).



Automatic Caps Lock is used if you change the Caps Lock key on and off. The software tracks and reflects if you have Caps Lock on or off. This selection can only be used with systems that have an LED that notes the Caps Lock status (AT keyboards).



Autocaps via NumLock bar code should be scanned in countries (e.g., Germany, France) where the Caps Lock key cannot be used to toggle Caps Lock. The NumLock option works similarly to the regular Autocaps, but uses the NumLock key to retrieve the current state of the Caps Lock.



Emulate External Keyboard should be scanned if you do not have an external keyboard (IBM AT or equivalent).



Note: After scanning the Emulate External Keyboard bar code, you must power cycle your computer.

Keyboard Conversion

Alphabetic keyboard characters can be forced to be all upper case or all lowercase. So if you have the following bar code: "abc569GK," you can make the output "ABC569GK" by scanning **Convert All Characters to Upper Case**, or to "abc569gk" by scanning **Convert All Characters to Lower Case**.

These settings override [Keyboard Style](#) selections.

Note: If your interface is a keyboard wedge, first scan the menu code for [Automatic Caps Lock](#) (page 2-15). Otherwise, your output may not be as expected.

Default = Keyboard Conversion Off.





Control Character Output

This selection sends a text string instead of a control character. For example, when the control character for a carriage return is expected, the output would display [CR] instead of the ASCII code of 0D. Refer to [ASCII Conversion Chart \(Code Page 1252\)](#) on page A-3. Only codes 00 through 1F are converted (the first column of the chart). *Default = Off.*

Note: Control + X (Control + ASCII) Mode overrides this mode.



Keyboard Modifiers

This modifies special keyboard features, such as CTRL+ ASCII codes and Turbo Mode.

Control + X (Control + ASCII) Mode On: The scanner sends key combinations for ASCII control characters for values 00-1F. Windows is the preferred mode. All keyboard country codes are supported. DOS mode is a legacy mode, and it does not support all keyboard country codes. New users should use the Windows mode. Refer to [Keyboard Function Relationships](#), page 9-1 for CTRL+ X Values.

Windows Mode Prefix/Suffix Off: The scanner sends key combinations for ASCII control characters for values 00-1F, but it does not translate prefix or suffix information.

Default = Control + X Mode Off.





KBCAS3.

Windows Mode Prefix/Suffix Off

Turbo Mode: The scanner sends characters to a terminal faster. If the terminal drops characters, do not use Turbo Mode.
Default = Off.



KBDTMD1.

Turbo Mode On



KBDTMD0.

*** Turbo Mode Off**

Numeric Keypad Mode: Sends numeric characters as if entered from a numeric keypad. *Default = Off.*



KBDNPS1.

Numeric Keypad Mode On



KBDNPS0.

*** Numeric Keypad Mode Off**

Automatic Direct Connect Mode: This selection can be used if you have an IBM AT style terminal and the system is dropping characters. *Default = Off.*



KBDADC1.

**Automatic Direct Connect Mode
On**



KBDADC0.

*** Automatic Direct Connect
Mode Off**

RS232 Modifiers

RS232 Baud Rate

Baud Rate sends the data from the scanner to the terminal at the specified rate. The host terminal must be set for the same baud rate as the scanner. *Default = 115,200.*



232BAD0.

300



232BAD1.

600



232BAD2.

1200



232BAD3.

2400



232BAD4.

4800



232BAD5.

9600



232BAD6.

19200



232BAD7.

38400



232BAD8.

57,600



232BAD9.

* 115,200

RS232 Word Length: Data Bits, Stop Bits, and Parity

Data Bits sets the word length at 7 or 8 bits of data per character. If an application requires only ASCII Hex characters 0 through 7F decimal (text, digits, and punctuation), select 7 data bits. For applications that require use of the full ASCII set, select 8 data bits per character. *Default = 8.*

Stop Bits sets the stop bits at 1 or 2. *Default = 1.*

Parity provides a means of checking character bit patterns for validity.
Default = None.



232WRD3.

7 Data, 1 Stop, Parity Even



232WRD0.

7 Data, 1 Stop, Parity None



232WRD6.

7 Data, 1 Stop, Parity Odd



232WRD4.

7 Data, 2 Stop, Parity Even



232WRD1.

7 Data, 2 Stop Parity None



232WRD7.

7 Data, 2 Stop, Parity Odd



232WRD5.

8 Data, 1 Stop, Parity Even



232WRD2.

*** 8 Data, 1 Stop, Parity None**



232WRD8.

8 Data, 1 Stop, Parity Odd



232WRD14.

8 Data, 1 Stop, Parity Mark

RS232 Receiver Time-Out

The unit stays awake to receive data until the RS232 Receiver Time-Out expires. A manual or serial trigger resets the time-out. When an RS232 receiver is sleeping, a character may be sent to wake up the receiver and reset the time-out. A transaction on the CTS line will also wake up the receiver. The receiver takes 300 milliseconds to completely come up. Change the RS232 receiver time-out by scanning the bar code below, then scanning digits from the inside back cover of this manual, then scanning **Save**. The range is 0 to 300 seconds. *Default = 0 seconds (no time-out - always on).*



232LPT.
RS232 Receiver Time-Out

RS232 Handshaking

RS232 Handshaking allows control of data transmission from the scanner using software commands from the host device. When RTS/CTS is turned **Off**, no data flow control is used.

Flow Control, No Timeout: The scanner asserts RTS when it has data to send, and will wait indefinitely for CTS to be asserted by the host.

Two-Direction Flow Control: The scanner asserts RTS when it is OK for the host to transmit. The host asserts CTS when it is OK for the device to transmit.

Flow Control with Timeout: The scanner asserts RTS when it has data to send and waits for a delay (see [RS232 Timeout](#) on page 2-20) for CTS to be asserted by the host. If the delay time expires and CTS is not asserted, the device transmit buffer is cleared and scanning may resume. *Default = RTS/CTS Off.*



232CTS1.
Flow Control, No Timeout



232CTS2.
Two-Direction Flow Control



232CTS3.
Flow Control with Timeout



232CTS0.
* RTS/CTS Off

RS232 Timeout

When using Flow Control with Timeout, you must program the length of the delay you want to wait for CTS from the host. Set the length (in milliseconds) for a timeout by scanning the bar code below, then setting the timeout (from 1-5100 milliseconds) by scanning digits from the inside back cover, then scanning **Save**.



232DEL.
RS232 Timeout

XON/XOFF

Standard ASCII control characters can be used to tell the scanner to start sending data (**XON/XOFF On**) or to stop sending data (**XON/XOFF Off**). When the host sends the XOFF character (DC3, hex 13) to the scanner, data transmission stops. To resume transmission, the host sends the XON character (DC1, hex 11). Data transmission continues where it left off when XOFF was sent. *Default = XON/XOFF Off.*



ACK/NAK

After transmitting data, the scanner waits for an ACK character (hex 06) or a NAK character (hex 15) response from the host. If ACK is received, the communications cycle is completed and the scanner looks for more bar codes. If NAK is received, the last set of bar code data is retransmitted and the scanner waits for ACK/NAK again. Turn on the ACK/NAK protocol by scanning the **ACK/NAK On** bar code below. To turn off the protocol, scan **ACK/NAK Off**. *Default = ACK/NAK Off.*



Scanner to Bioptic Communication

The following settings are used to set up communication between Honeywell scanners and bioptic scanners.

Note: The scanner's baud rate must be set to 38400 and the RS232 timeout must be set to 3000 in order to communicate with a bioptic scanner. See "RS232 Modifiers" on page 2-18, and [RS232 Timeout](#) on page 2-20 for further information.

Scanner-Bioptic Packet Mode

Packet Mode On must be scanned to set the scanner's format so it is compatible with a bioptic scanner. *Default = Packet Mode Off.*



Scanner-Bioptic ACK/NAK Mode

Bioptic ACK/NAK On must be scanned so the scanner will wait for an ACK or NAK from a bioptic scanner after each packet is sent. The Scanner-Bioptic ACK/NAK Timeout (below) controls how long the scanner will wait for a response.

Default = Bioptic ACK/NAK Off.



232NAK0.

* Bioptic ACK/NAK Off



232NAK1.

Bioptic ACK/NAK On

Scanner-Bioptic ACK/NAK Timeout

This allows you to set the length (in milliseconds) for a timeout for a bioptic scanner's ACK/NAK response. Scan the bar code below, then set the timeout (from 1-30,000 milliseconds) by scanning digits from the inside back cover, then scanning **Save**. *Default = 5100.*



232DLK.

ACK/NAK Timeout

Cordless System Operation

Note: This chapter applies only to cordless scanning systems. It does not apply to corded scanners.

How the Cordless Charge Base/Access Point Works

A cordless charge base or an Access Point provide the link between the cordless scanner and the host system. The base/Access Point contains an interface assembly and an RF communication module. The RF communication module performs the data exchange between the cordless scanner and the interface assembly. The control assembly coordinates the central interface activities including: transmitting/receiving commands and data to/from the host system, performing software activities (parameter menuing, visual indicator support, power-on diagnostics), and data translation required for the host system.

The cordless charge base is also a scanner's battery charger. Refer to [Charging Information](#), page 3-4, for additional information.

Linking the Scanner to a Charge Base

Turn off power before connecting a base, then power up the computer once the base is fully connected. When the base is connected and powered up, put the scanner in the base to establish a link. The green LED on the base flashes to indicate the scanner's battery is charging.

If the scanner and base have previously been linked, you do not receive any feedback. If this is the first time that the scanner and base are linked, both devices emit a short chirp when their radios link. At this point, that one scanner is linked to one base.

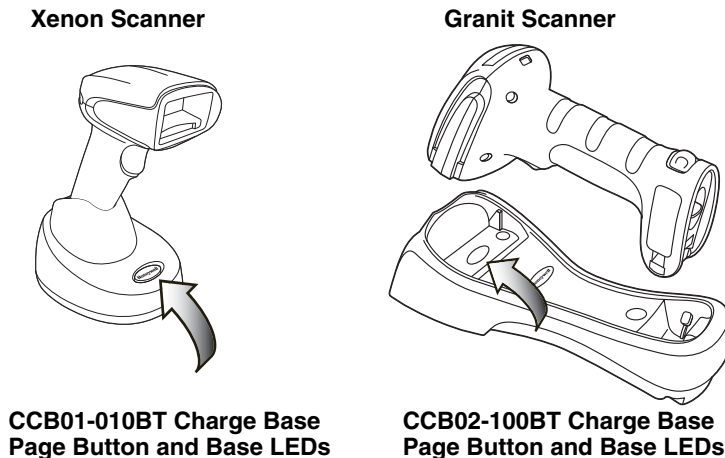

To determine if your cordless system is set up correctly, scan one of the sample bar codes in the back of this manual. If the scanner provides a single good read beep and the green LED lights, the scanner has successfully linked to the base. If using a Granit scanner, the scanner also vibrates. If you receive an error tone and the red LED lights, the scanner has not linked to the base. Refer to [page 13-4](#) for troubleshooting information.

Linking the Scanner to an Access Point

Turn on the computer (laptop/desktop). Plug the interface cable into the Access Point first and then into the appropriate port on the computer. The Page button lights up when the connection to the host is made.

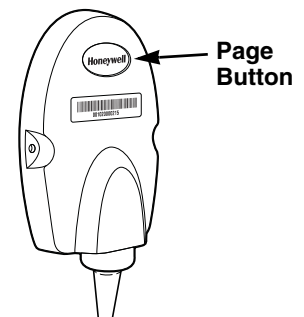

Scan the linking bar code on the top of the Access Point to establish a connection between the Access Point and the scanner. The scanner emits a short beep and flashes the green LED to confirm a connection with the Access Point. The Access Point's Page button remains blue.

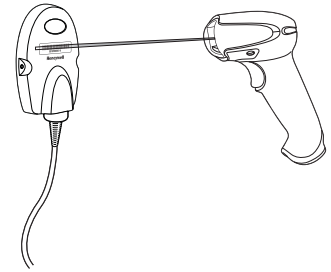

Replacing a Linked Scanner

If you need to replace a broken or lost scanner that is linked to a base or an Access Point, scan the **Override Locked Scanner** bar code below with a new scanner and place that scanner in the base, or scan the Access Point linking bar code. The locked link will be overridden; the broken or lost scanner's link with the base or Access Point will be removed, and the new scanner will be linked.



Communication Between the Cordless System and the Host

The cordless scanner provides immediate feedback in the form of a "good read" indication with a green LED on the scanner and an audible beep. If using a Granit scanner, the scanner also vibrates. This indicates that the bar code has been scanned correctly and the base or Access Point has acknowledged receiving the data. This is possible since the cordless system provides two-way communication between the scanner and the base or Access Point.

When data is scanned, the data is sent to the host system via the base or Access Point. The cordless scanner recognizes data acknowledgement (ACK) from the base or Access Point. If it cannot be determined that the data has been properly sent to the base or Access Point, the scanner issues an error indication. You must then check to see if the scanned data was received by the host system.

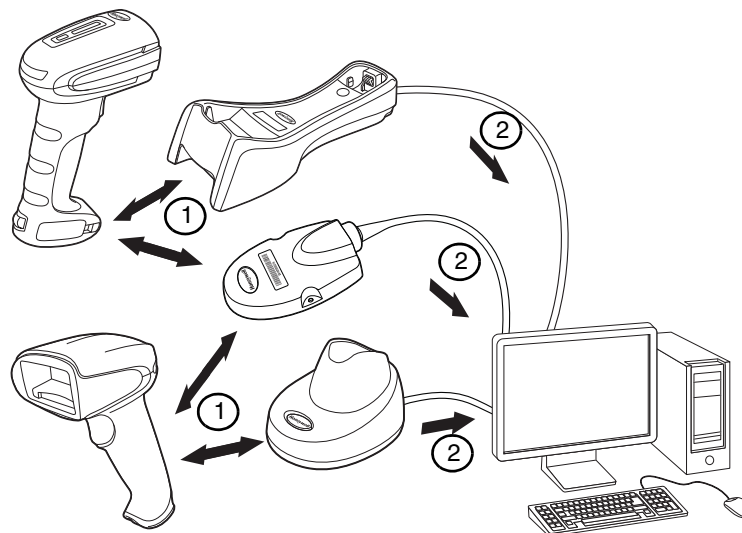

1. Scanner reads code and gets ACK from base or Access Point
2. Base or Access Point sends data to host

Programming the Scanner and Base or Access Point

When using the scanner and charge base or Access Point together as a system, menu parameters and configuration settings are stored in the charge base or Access Point. Therefore, when programming any menu configuration settings, the scanner must be linked to the intended charge base or Access Point.

Note: This only applies when the scanner is linked to a charge base or Access Point. If the scanner is in a non-base mode, configuration settings are stored in the scanner.

RF (Radio Frequency) Module Operation

The cordless system uses a two-way Bluetooth® radio to transmit and receive data between the scanner and the base or Access Point. Designed for point-to-point and multipoint-to-single point applications, the radio operates using a license free ISM band, which sends relatively small data packets at a fast data rate over a radio signal with randomly changing frequencies, makes the cordless system highly responsive to a wide variety of data collection applications and resistant to noisy RF environments. The CCB01-010BT (Bluetooth Class 2) provides a communication range of 33 feet (10m) between the scanner and base or Access Point, depending on the environment. The CCB02-100BT (Bluetooth Class 1) provides a communication range of 330 feet (100m) between the scanner and base or Access Point, depending on the environment. See [Flexible Power Management](#), page 3-12, for information about controlling this range.

System Conditions

The components of the cordless system interact in specific ways as you associate a scanner to a base or Access Point, as you move a scanner out of range, bring a scanner back in range, or swap scanners between two cordless systems. The following information explains the cordless system operating conditions.

Linking Process

Once a scanner is placed into a cordless charge base, the scanner's battery charge status is checked, and software automatically detects the scanner and links it to the base depending on the selected link mode.

Refer to [Linking the Scanner to an Access Point](#), page 3-1, for information about linking to an Access Point.

Scanner Is Out of Range

The cordless scanner is in communication with its base or Access Point, even when it is not transmitting bar code data. Whenever the scanner can't communicate with the base or Access Point for a few seconds, it is out of range. If the scanner is out of range and you scan a bar code, the scanner issues an error tone indicating no communication with the base or Access Point. A cordless charge base can also sound an alarm. Refer to [Out-of-Range Alarm](#), page 3-10.

Scanner Is Moved Back Into Range

The scanner relinks if the scanner or the base or Access Point have been reset, or the scanner comes back into range. If the scanner relinks, you will hear a single chirp when the relinking process (uploading of the parameter table) is complete. Refer to [Out-of-Range Alarm](#) on page 3-10 for further information.

Out of Range and Back into Range with Batch Mode On

The scanner may store a number of symbols (approximately 500 U.P.C. symbols; others may vary) when it is out of range and then send them to the base or Access Point when back in range (see [Batch Mode](#) on page 3-13).

You will not hear a communication error tone in this mode, but you will hear a short buzz when you pull the trigger if the radio communication is not working. Once the radio connection is made, the scanner produces a series of beeps while the data is being transferred to the base or Access Point.

Page Button

When you press the Page button on the base or Access Point, the scanners associated with that base or Access Point will begin beeping (3 short and 1 long beep). If you pull the trigger on a scanner that is beeping in response, or press the Page button on the base or Access Point a second time, all associated scanners will stop beeping. See [Paging](#) on page 3-7 for further information about Page Button settings.

About the Battery



There is a danger of explosion if the batteries are incorrectly replaced. Replace the batteries with only the same or equivalent type recommended by the manufacturer. Dispose of used batteries according to the recycle program for batteries as directed by the governing agency for the country where the batteries are to be discarded.

Power is supplied to the cordless scanner by a rechargeable battery that is integrated in the scanner handle. Batteries are shipped approximately 30% to 60% charged. The battery should be charged for a minimum of 4 hours before initial use to ensure optimal performance.

Charging Information

The battery is designed to charge while the scanner is positioned in the cordless base unit. Refer to [Base/Access Point LED Sequences and Meaning](#), page 3-5, for an interpretation of the Charge Status indicators. Refer to [Charge Only Mode](#) (page 3-9) if you need to charge a scanner without linking it to the base.

Place the scanner in the base that is connected to an appropriate power supply. Use only a Listed Limited Power Source (LPS) or Class 2 type power supply with output rated 5 to 5.2Vdc, 1A.

Note: If you are powering the base through the interface cable (for example, a USB cable) and not using an external power supply plugged into the aux port, the current available for charging is reduced and charge times are increased.

Battery Recommendations

- The battery is a lithium ion cell and can be used without a full charge, and can also be charged without fully discharging, without impacting the battery life. There is no need to perform any charge/discharge conditioning on this type of battery.
- Keep the base connected to power when the host is not in use.
- Replace a defective battery immediately since it could damage the scanner.
- Although your battery can be recharged many times, it will eventually be depleted. Replace it after the battery is unable to hold an adequate charge.
- If you are not sure if the battery or charger is working properly, send it to Honeywell International Inc. or an authorized service center for inspection. Refer to [Customer Support](#) on page 14-1 for additional information.



Caution:

Use only Honeywell Li-ion battery packs, model number BAT-SCN01, rated 3.7 Vdc, 7.4Whr in this device. Use of any non-Honeywell battery may result in damage not covered by the warranty.

Safety Precautions for Lithium Batteries

- Do not place batteries in fire or heat the batteries.
- Do not store batteries near fire or other high temperature locations.
- Do not store or carry batteries together with metal objects.
- Do not expose batteries to water or allow the batteries to get wet.
- Do not connect (short) the positive and negative terminals, of the batteries, to each other with any metal object.
- Do not pierce, strike or step on batteries or subject batteries to strong impacts or shocks.
- Do not disassemble or modify batteries.



Caution:

Danger of explosion if batteries are incorrectly replaced. Dispose of used batteries according to the recycle program for batteries as directed by the governing agency for the country where the batteries are to be discarded.

Proper Disposal of the Battery



When the battery has reached the end of its useful life, the battery should be disposed of by a qualified recycler or hazardous materials handler. Do not incinerate the battery or dispose of the battery with general waste materials. You may send the scanner's battery to us. (postage paid). The shipper is responsible for complying with all federal, state, and local laws and regulations related to the packing, labeling, manifesting, and shipping of spent batteries. Contact the Product Service Department ([page 14-1](#)) for recycling or disposal information. Since you may find that your cost of returning the batteries significant, it may be more cost effective to locate a local recycle/disposal company.

Beeper and LED Sequences and Meaning

The scanner contains LEDs on the rear of the unit that indicate linking status, decoding state, and battery condition. The base has LEDs on the top of the unit that indicate its power up, communication, and battery charge condition. The red LED = error; green LED = success of any type. Scanners and the CCB01-010BT base have audible indicators as well: 1 razz or error tone = error; 2 beeps = menu change; 1 beep = all other successes.

The table below lists the indication and cause of the LED indication, beeps, and vibrations for the scanner.

Scanner LED Sequences and Meaning

| LED Indication | Beeper Indication | Vibrate Indication | Cause |
|-------------------------|--------------------|--------------------|-------------------------------------|
| Normal Operation | | | |
| Red Flash | None | None | Battery low |
| Green Flash | 1 beep | None | Successful communication or linking |
| Red, blinking | Razz or error tone | None | Failed communication |
| Menu Operation | | | |
| Green Flash | 2 beeps | 2 vibrations | Successful menu change |
| Red, blinking | Razz or error tone | 1 long vibration | Unsuccessful menu change |

Base/Access Point LED Sequences and Meaning

The base contains a red LED and the Access Point has a blue LED that indicate the status of the unit and verifies its communication with the host system. The base also has a green LED that indicates scanner battery charge condition.

| Red or Blue LED - Host Communication | |
|---|--|
| Red or Blue LED | Communication Condition |
| Off | USB suspend |
| On continuously | Power on, system idle |
| Short blinks in multiple pulses. Occurs while transferring data to/from the RF module or the Host port. | Receiving data |
| Green LED - Scanner Battery (base only, does not apply to Access Point) | |
| Green LED | Charge Condition |
| Off | Battery not detected or charge suspended |
| Slow flash, 1 second on, 1 second off | Pre-charge and charging |
| On continuously | Charge complete |
| Fast flash, 300 mSec on, 300 mSec off | Charge Error |

Base Power Communication Indicator

To display the power indicator on a base or an Access Point, scan the **Base Power Communication Indicator On** bar code. To turn off the power indicator, scan the **Off** bar code. *Default = On.*



*:BASRED1.

* Base Power Communication
Indicator On



*:BASREDQ.
Base Power Communication
Indicator Off

Reset Scanner

Scanning this bar code reboots the scanner and causes it to relink with the base or Access Point.



RESET_
Reset Scanner

Scanning While in Base Cradle

Note: This feature only applies to the CCB01-010BT base.

If you want to be able to scan bar codes while the scanner is in the base cradle, scan the **Scanning in Cradle On** bar code below. If you want to only allow scanning when the scanner is out of the base cradle, scan **Scanning in Cradle Off**. If you want the scanner to shut down when in the base cradle, scan **Shut Down Scanner in Cradle**. *Default = Scanning in Cradle On (for CCB01-010BT).*



BT_SIC0.
Scanning in Cradle Off



BT_SIC1.
* Scanning in Cradle On



BT_SIC2.
Shut Down Scanner in Cradle

Base Charging Modes

When the base has both an external power supply (plugged into the auxiliary power port) and a host interface cable, it will draw its power from the external power supply. When the base does not have an external power supply, it draws its power from the interface cable. However, the scanner battery charges more slowly from a host interface cable than if auxiliary power were available. Using the following selections, you can specify whether the scanner battery is charged from power supplied via the host interface cable.

When **Base Charge Off** is selected, the scanner battery does not charge when the scanner is in the base cradle.

When **External or Interface Cable Power** is selected, the scanner battery charges from the base's external power supply, if there is one. If there is no external power supply to the base, the scanner battery charges from the interface cable.

When **External Power Only** is selected, the scanner battery only charges from the base's external power supply. If there is no external power supply, the scanner battery does not charge.

*Note: If you are using a cordless charge base in [Presentation Mode](#), **External Power Only** is the only setting available.*

Default = External or Interface Cable Power.



BASCHG0.
Base Charge Off



BASCHG1.
External or Interface Cable
Power



BASCHG2.
External Power Only

Paging

Paging Mode

By default, the paging button on the base or Access Point pages the scanners associated with that base or Access Point. If you want the paging button on your base or Access Point to be disabled, scan the **Paging Mode Off** bar code, below. When Paging Mode is off, the base or Access Point will no longer page scanners when the button is pressed. The red LED on the base or blue LED on the Access Point will remain lit to indicate that Paging Mode is off. (This light will go out when the button is pressed, then back on when it's released.) *Default = Paging Mode On.*



BEPPGE1.
* Paging Mode On



BEPPGE0.
Paging Mode Off

Paging Pitch

When you press the Page button on the base or Access Point, the scanners associated with that base or Access Point will begin beeping (see [Page Button](#) on page 3-3). You can set the pitch of the paging beep for each scanner by scanning one of the following bar codes. *Default = Low.*



BEPPFQ1000.
* Low (1000 Hz)



BEPPFQ3250.
Medium (3250 Hz)



BEPPFQ4200.
High (4200 Hz)

Error Indicators

Beeper Pitch - Base Error

Note: This feature only applies to the CCB01-010BT base.

The CCB01-010BT base can be configured to beep at a particular pitch when an error occurs, such as transmission problems to a host system. The beeper pitch codes modify the pitch (frequency) of the error tone the base emits when there is an error. *Default = Low.*



BASFQ2250.
* Razz (250 Hz)



BASFQ23250.
Medium (3250 Hz)



BASFQ24200.
High (4200 Hz)

Number of Beeps - Base Error

Note: This feature only applies to the CCB01-010BT base.

The number of beeps and LED flashes emitted by the CCB01-010BT base for an error condition can be programmed from 1 - 9. For example, if you program this option to have five error beeps, there will be five error beeps and five LED flashes in response to an error. To change the number of error beeps, scan the bar code below and then scan a digit (1-9) bar code and the **Save** bar code on the [Programming Chart](#) inside the back cover of this manual. *Default = 1.*



BASERR.
Number of Base Error Beeps/LED Flashes

Scanner Report

Scan the bar code below to generate a report for the connected scanners. The report indicates the port, work group, scanner name, and address. To assign a name to your scanner, refer to [Menu Command Syntax](#), page 11-1.



RPTSCN.
Scanner Report

Scanner Address

Scan the bar code below to determine the address of the scanner you are using.



Base or Access Point Address

Scan the bar code below to determine the address of the base or Access Point you are using.



Scanner Modes

Your scanner is capable of working in single scanner mode, multiple scanner mode, or with Bluetooth devices other than the charge base or Access Point.

Charge Only Mode

There may be times when you want to charge your scanner, but not link to the base. For example, if a scanner is linked to an Access Point or other Bluetooth device and you need to charge the scanner, but want to retain your existing link.

In order to program the base for Charge Only Mode, you must link a scanner to it. Once the scanner is linked to the base, scan the **Charge Only Mode** bar code. Any subsequent scanners placed in that base will charge without linking to it. The scanner used to program the base remains linked to the base. To unlink this scanner, scan [Unlink Scanner](#) on page 3-10.



Note: When in Charge Only Mode, the scanner periodically wakes up and beeps. See "Power Up Beeper" on page 4-1 to change this setting.

If you want to charge a scanner and link to the base, use **Charge and Link Mode**. If the base is programmed for Charge Only Mode, you must link a scanner to it first in order to program it for Charge and Link Mode. Scan the linking bar code on the base to link the scanner, then scan **Charge and Link Mode**. *Default = Charge and Link Mode.*



Linked Modes

Locked Link Mode and Open Link Mode are the link modes that accommodate different applications. Scan the appropriate bar codes included in the Open Link and Locked Link Mode explanations that follow to switch from one mode to another.

Default = Open Link Mode.

Locked Link Mode - Single Scanner

If you link a scanner to a base or an Access Point using the Locked Link Mode, other scanners are blocked from being linked if they are inadvertently placed into the base, or if the Access Point linking bar code is scanned. If you do place a different scanner into a base, it will charge the scanner, but the scanner will not be linked.



To use a different scanner, you need to unlink the original scanner by scanning the **Unlink Scanner** bar code. (See [Scanner Modes](#), page 3-9.)

Open Link Mode - Single Scanner

When newly shipped or defaulted to factory settings, a scanner is not linked to a base or an Access Point. A link is established when the scanner is placed into a base, or an Access Point linking bar code is scanned. When in Open Link Mode, a new link is established when a new scanner is placed in the base, or you scan an Access Point linking bar code. Each time a scanner is placed into a base or scans an Access Point linking bar code, the scanner becomes linked to the base or Access point and the old scanner is unlinked.



Unlinking the Scanner

If a base or an Access Point has a scanner linked to it, that scanner must be unlinked before a new scanner can be linked. Once the previous scanner is unlinked, it will no longer communicate with the base or Access Point. To unlink the scanner from a base or an Access Point, scan the **Unlink Scanner** bar code below.



Override Locked Scanner

If you need to replace a broken or lost scanner that is linked to a base or an Access Point, scan the **Override Locked Scanner** bar code below with a new scanner and place that scanner in the base, or scan the Access Point linking bar code. The locked link will be overridden; the broken or lost scanner's link with the base or Access Point will be removed, and the new scanner will be linked.



Out-of-Range Alarm

If your scanner is out range of the base, an alarm sounds from both your base and scanner. If your scanner is out range of an Access Point, an alarm sounds from just the scanner. The alarm stops when the scanner is moved closer to the base or Access Point, when the base or Access Point connects to another scanner, or when the alarm duration expires. To activate the alarm

options for the scanner or the base and to set the alarm duration, scan the appropriate bar code below and then set the time-out duration (from 0-3000 seconds) by scanning digits on the [Programming Chart](#) inside the back cover, then scanning **Save**.
Default = 0 sec (no alarm).



Note: The Access Point does not have a base alarm.



Note: If you are out of range when you scan a bar code, you will receive an error tone even if you do not have the alarm set. You receive the error tone since the data could not be communicated to the base or Access Point or the host.

Alarm Sound Type

You may change the alarm type for the scanner or a CCB01-010BT base by scanning the appropriate bar code below and then scanning a digit (0-7) bar code and the **Save** bar code on the [Programming Chart](#) inside the back cover of this manual.
Default = 0.

The sounds are as follows:

| Setting | Sound |
|---------|--------------------------------------|
| 0 | 3 long beeps, medium pitch |
| 1 | 3 long beeps, high pitch |
| 2 | 4 short beeps, medium pitch |
| 3 | 4 short beeps, high pitch |
| 4 | single chirps, medium pitch |
| 5 | 2 chirps, then 1 chirp, medium pitch |
| 6 | single chirps, high pitch |
| 7 | 2 chirps, then 1 chirp, high pitch |



Note: Only the CCB01-010BT base has an alarm.



Scanner Power Time-Out Timer

Note: Scanner Power Time-out Timer only applies to cordless systems. It does not apply to corded scanners.

When there is no activity within a specified time period, the scanner enters low power mode. Scan the appropriate scanner power time-out bar code to change the time-out duration (in seconds).

Note: Scanning zero (0) is the equivalent of setting no time-out.

If there are no trigger pulls during the timer interval, the scanner goes into power down mode. Whenever the trigger is enabled, the timer is reset. If the scanner is placed in the charge base cradle and the battery is in the process of being charged, the scanner will not go into power down mode. *Default = 3600 seconds.*



Note: When the scanner is in power down mode, pull the trigger to power the unit back up. There will be a set of power up beeps and a delay of up to a few seconds for the radio to join. The scanner will then be ready to use.

Flexible Power Management

If you are experiencing network performance issues, and suspect the scanner is interfering with other devices, you can turn down the power output of the scanner. This reduces the range between the scanner and a base or an Access Point as shown in the following illustration:

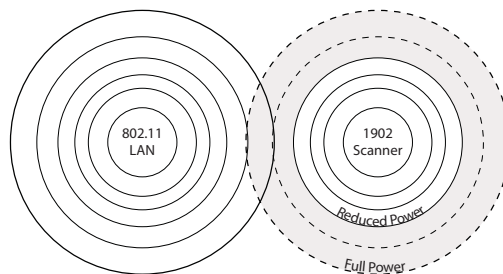

Scan one of the bar codes below to set the scanner's power output to **Full Power** (100%), **Medium Power** (35%), **Medium Low Power** (5%), or **Low Power** (1%). *Default = Full Power.*

Note: Setting a Granit scanner to anything lower than Full Power changes it to Class II Bluetooth.



BT_TXP100.
* Full Power



BT_TXP35.
Medium Power



BT_TXP5.
Medium Low Power



BT_TXP1.
Low Power

Batch Mode

Batch mode is used to store bar code data when a scanner is out of range of its base or Access Point, or when performing inventory. The data is transmitted to the base or Access Point once the scanner is back in range or when the records are manually transmitted.

Note: Batch mode has limitations when using multiple scanners to one base or Access Point. If a cordless system is being used in "multiple link mode," where up to 7 scanners are to be connected to one base or Access Point, some accumulated or batched scans could be lost if scanners are constantly being moved in and out of range.

Automatic Batch Mode stores bar code data when the scanner is out of range of the base or Access Point. The data is automatically transmitted to the base or Access Point once the scanner is back in range. When the scanner's buffer space is full, any bar codes scanned generate an error tone. In order to scan bar codes again, the scanner must be moved back into range of the base or Access Point so data can be transmitted.

Inventory Batch Mode stores bar code data, whether or not you are in range of the base or Access Point. To transmit the stored data to the base or Access Point, either place the scanner in the base, or scan [Transmit Inventory Records](#) (page 3-17). When the scanner's buffer space is full, any bar codes scanned generate an error tone. In order to scan bar codes again, the data must be transmitted to the base or Access Point. Once the data is transmitted, it is cleared in the scanner.

Persistent Batch Mode is the same as Inventory Batch Mode, except that once the data is transmitted to the base or Access Point, it is retained in the scanner. If you want to transmit more than once, you can do so using this mode. In order to clear the scanner's buffer, you must scan [Clear All Codes](#) (see page 3-17).

Default = Batch Mode Off.



BATENA0.
* Batch Mode Off



BATENA1.
Automatic Batch Mode



BATENA2.
Inventory Batch Mode



BATENA3.
Persistent Batch Mode

Batch Mode Beep

When scanning in [Inventory Batch Mode](#) (page 3-14), the scanner beeps every time a bar code is scanned. If using a Granit scanner, it also vibrates. When **Batch Mode Beep** is **On**, you will also hear a click when each bar code is sent to the host. If you do not want to hear these clicks, scan **Batch Mode Beep Off**. *Default = Batch Mode Beep On.*



BATBEP0.
Batch Mode Beep Off



BATBEP1.
* Batch Mode Beep On

Batch Mode Storage

When a scanner is storing data during a Batch Mode process, you can select whether the data is stored in Flash memory or in RAM.

Flash Storage: The scanner writes any untransmitted data to flash memory prior to powering down. The data will still be there when the scanner powers back up. However, the scanner will power down, even with untransmitted data, if it reaches a power down timeout or if the battery power is very low.

RAM Storage: The scanner will not power down while it contains data that has not been transmitted to the base or Access Point, even if it reaches a power down timeout. However, if the scanner runs out of battery power, it will power down and the data will be lost.

Default = Flash Storage.



BATNVS1.
* Flash Storage



BATNVS0.
RAM Storage

Batch Mode Quantity

When in Batch Mode, you may wish to transmit the number of multiple bar codes scanned, rather than a single bar code multiple times. For example, if you scan three bar codes called XYZ with **Batch Mode Quantity Off**, when you transmit your data it will appear as XYZ three times. Using **Batch Mode Quantity On** and the **Quantity Codes** (page 3-16), you could output your data as “XYZ, 00003” instead.

Note: If you wish to format your output, for example, place a CR or tab between the bar code data and the quantity, refer to [Data Formatting](#) beginning on page 6-1.

Default = Batch Mode Quantity Off.



BATQTY0.

* Batch Mode Quantity Off



BATQTY1.

Batch Mode Quantity On

Entering Quantities

Quantity Codes (page 3-16) allow you to enter a quantity for the last item scanned, up to 9999 (default = 1). Quantity digits are shifted from right to left, so if a 5th digit is scanned, the 1st digit scanned is discarded and the 2nd, 3rd and 4th digits are moved to the left to accommodate the new digit.

For example, if the Quantity 5 bar code is scanned after the quantity has been set to 1234, then the 1 is dropped, the quantity will be 2345.

Example: Add a quantity of 5 for the last item scanned.

1. Scan the item's bar code.
2. Scan the quantity 5 bar code.

Example: Add a quantity of 1,500 for the last item scanned.

1. Scan the item's bar code.
2. Scan the quantity 1 bar code.
3. Scan the quantity 5 bar code.
4. Scan the quantity 0 bar code.
5. Scan the quantity 0 bar code.

Example: Change a quantity of 103 to 10.

To correct an incorrect quantity, scan the quantity 0 bar code to replace the incorrect digits, then scan the correct quantity bar codes.

1. Scan the quantity 0 bar code to change the quantity to 1030.
2. Scan the quantity 0 bar code to change the quantity to 0300.
3. Scan the quantity 1 bar code to change the quantity to 3001.
4. Scan the quantity 0 bar code to change the quantity to 0010.

Default = 1.

Quantity Codes



BATNUM0.

0



BATNUM2.

2



BATNUM4.

4



BATNUM6.

6



BATNUM8.

8



BATNUM1.

1



BATNUM3.

3



BATNUM5.

5



BATNUM7.

7



BATNUM9.

9

Batch Mode Output Order

When batch data is transmitted, select whether you want that data sent as **FIFO** (first-in first-out), or **LIFO** (last-in first-out).

Default = Batch Mode FIFO.



BATLIFO.

* Batch Mode FIFO



BATLIF1.

Batch Mode LIFO

Total Records

If you wish to output the total number of bar codes scanned when in Batch Mode, scan **Total Records**.



Delete Last Code

If you want to delete the last bar code scanned when in Batch Mode, scan **Delete Last Code**.



Clear All Codes

If you want to clear the scanner's buffer of all data accumulated in Batch Mode, scan **Clear All Codes**.



Transmit Records to Host

If you are operating in Inventory Batch Mode (see [Inventory Batch Mode](#) on page 3-14), you must scan the following bar code to transmit all the stored data to the host system.



Batch Mode Transmit Delay

Sometimes when accumulated scans are sent to the host system, the transmission of those scans is too fast for the application to process. To program a transmit delay between accumulated scans, scan one of the following delays. *Default = Off.*

Note: In most cases, a short (250 ms (milliseconds)) delay is ideal, however, longer delays may be programmed. Contact Technical Support ([page 14-1](#)) for additional information.





Multiple Scanner Operation

Note: Multiple Scanner Operation Mode allows you to link up to 7 scanners to one base or Access Point. You cannot join an 8th scanner until you unlink one of the 7 scanners or take a scanner out of range.

To put the scanner in multiple scanner mode, scan the bar code below. Once you scan this bar code, the scanner is unlinked from the base or Access Point and must either be placed into the base, or you must scan the Access Point linking bar code in order to relink.



Scanner Name

You may assign a name to each scanner you are using for identification purposes. For example, you may want to have a unique identifier for a scanner that is receiving imaging commands sent from the base or Access Point.

The default name is in the format “ScannerName_Model_SN_XXXXXXXXXX” If you have more than one scanner linked to a base, and they all have the same name, the first scanner linked to the base receives commands. When renaming a series of scanners with identical names, unlink all except one of the scanners from the base.

Perform the rename operation using either the bar codes on [page 3-19](#), or by sending the serial command **:ScannerName:BT_NAMNewName**. where *ScannerName* is the current name of the scanner, and *NewName* is the new name for the scanner. If you wish to change the names of additional scanners, link them one at a time and repeat the **:ScannerName:BT_NAMNewName**. command for each scanner.

To rename scanners with sequential, numeric names, scan the bar codes below. Scan the **Reset** code after each name change and wait for the scanner to relink to the base or Access Point before scanning a bar code to rename the next scanner.





You may also scan the **Scanner Name** bar code below and scan a number for the scanner name. For example, if you wanted to name the linked scanner “312,” you would scan the bar code below, scan the **3**, **1**, and **2** bar codes on the [Programming Chart](#) inside the back cover of this manual, then scan **Save**. Scan the **Reset** bar code and wait for the scanner to relink to the base.



Application Work Groups

Your cordless system can have up to 7 scanners linked to one base or Access Point. You can also have up to 7 work groups. If you want to have all of the scanners’ settings programmed alike, you don’t need to use more than 1 work group. If you want each scanner to have unique settings (e.g., beeper volume, prefix/suffix, data formatter), then you may program each scanner to its own unique work group and may program each scanner independently. For example, you might want to have multiple work groups in a retail/warehouse application where you need to have different data appended to bar codes used in the warehouse area versus the retail area. You could assign all the scanners in the retail area to one work group and those in the warehouse to another. Consequently, any desired changes to either the retail or warehouse area would apply to all scanners in that particular work group. Honeywell’s online configuration tool, EZConfig-Scanning ([page 10-2](#)), makes it easy for you to program your system for use with multiple scanners and multiple work groups.

The scanner keeps a copy of the menu settings it is using. Whenever the scanner is connected or reconnected to a base or an Access Point, the scanner is updated with the latest settings from the base or Access Point for its work group. The scanner also receives menu setting changes processed by the base or Access Point. If a scanner is removed from a base or an Access Point and placed into another base or linked to another Access Point, it will be updated with the new base/Access Point settings for whatever work group to which that the scanner was previously assigned. For example, if the scanner was in work group 1 linked to the first base, it will be placed in work group 1 in the second base with the associated settings.

Application Work Group Selection

This programming selection allows you to assign a scanner to a work group by scanning the bar code below. You may then program the settings (e.g., beeper volume, prefix/suffix, data formatter) that your application requires. *Default = Group 0.*



GRPSEL0.
* Group 0



GRPSEL1.
Group 1



GRPSEL2.
Group 2



GRPSEL3.
Group 3



GRPSEL4.
Group 4



GRPSEL5.
Group 5



GRPSEL6.
Group 6

Resetting the Factory Defaults: All Application Work Groups

The following bar code defaults all of the work groups to the factory default settings.



PAPDFT&
Factory Default Settings:
All Work Groups

To see what the factory default settings are, refer to the table of [Menu Commands](#), beginning on page 11-4. The standard product default settings for each of the commands are indicated by an asterisk (*).

Note: Scanning this bar code also causes both the scanner and the base or Access Point to perform a reset and become unlinked. The scanner must be placed in the base, or the Access Point linking bar code must be scanned to re-establish the link. Refer to [Scanner Modes](#), page 3-9 for additional information.

If your scanner is in multiple scanner mode, you will hear up to 30 seconds of beeping while all scanners are relinked to the base or Access Point and the settings are changed.

Resetting the Custom Defaults: All Application Work Groups

If you want the custom default settings restored to all of the work groups, scan the **Custom Product Default Settings** bar code below. (If there are no custom defaults, it will reset the work groups to the factory defaults.) See "Setting Custom Defaults" on page 1-11 for further information about custom defaults.



PAPDFT.

**Custom Default Settings:
All Work Groups**

Note: Scanning this bar code also causes both the scanner and the base or Access Point to perform a reset and become unlinked. The scanner must be placed in its base, or the Access Point linking bar code must be scanned to re-establish the link. Refer to [Scanner Modes](#), page 3-9 for additional information.

If your scanner is in multiple scanner mode, you will hear up to 30 seconds of beeping while all scanners are relinked to the base or Access Point and the settings are changed.

Using the Scanner with Bluetooth Devices

The scanner can be used either with the charge base, an Access Point, or with other Bluetooth devices. Those devices include personal computers, laptops, PDAs, and Honeywell mobility systems devices.

Bluetooth HID Keyboard Connect

Your scanner can be paired with Bluetooth-capable devices, such as iPads, smart phones, and laptops, so that scanned data appears on your device screen as though it was entered on the keyboard. In order to pair with the Bluetooth device:

1. Scan the **Bluetooth HID Keyboard Connect** bar code below.



PAPBTH.

**Bluetooth HID Keyboard
Connect**

2. Set the Bluetooth-capable host device so it searches for other Bluetooth devices. (Refer to your device's User's Guide for pairing instructions.)
3. Once your host device has located the scanner, select the scanner name. The host generates and displays a random PIN that must be scanned within 60 seconds. You must quickly scan **Bluetooth PIN Code**, then the numbers below, then **Save**.



BT_PIN.

Bluetooth PIN Code



K0K

0



K1K

1



Virtual Keyboard

Once your scanner has been connected directly to an iPad, smart phone, or laptop, you can toggle the virtual keyboard on your device with a quick double pull of the scanner trigger.

Note: This feature is not supported in Granit devices.

Bluetooth HID Keyboard Disconnect

If your scanner has been connected directly to an iPad, smart phone, or laptop using [Bluetooth HID Keyboard Connect](#) (page 3-21), you must disconnect it in order to once again communicate with the base or Access Point. Scan the **Bluetooth HID Keyboard Disconnect** bar code to unlink the scanner from the currently linked host. Scan the linking bar code on the base or Access Point to relink the scanner.



PAPSPP.

Bluetooth HID Keyboard Disconnect

Bluetooth Serial Port - PCs/Laptops

Scanning the **Non-Base BT Connection** bar code below allows the scanner to be used with other Bluetooth devices (e.g., PC/laptop). When in this mode, the scanner behaves like an RS-232 serial device, and you will need to open a COM port on the host to read scanned data.

After you scan the bar code below, follow the instructions supplied with your Bluetooth device to locate the scanner and connect to it. If you go out of range with your scanner, the scanner will not reconnect to the Bluetooth device when it is back in range. If you want to relink to the charge base or Access Point, refer to [Override Locked Scanner](#), page 3-10.

Note: The multiple work groups option is not available when you are using the scanner with Bluetooth devices other than the charge base or Access Point.



BT_TRMD;BT_DNG5.

Non-Base BT Connection

PDAs/Mobility Systems Devices

You may also use the scanner with a PDA or a Honeywell Mobility Systems device. Scan the bar code below and follow the instructions supplied with your Bluetooth device to locate the scanner, and connect with it.



BT_TRMD;BT_DNG1.

BT Connection - PDA/Mobility Systems Device

Changing the Scanner's Bluetooth PIN Code

Some devices require a PIN code as part of the Bluetooth security features. Your scanner's default PIN is 1234, which you may need to enter the first time you connect to your PDA or PC. The PIN code must be between 1 and 16 characters. To change the PIN, scan the bar code below and then scan the appropriate numeric bar codes from the [Programming Chart](#) inside the back cover of this manual. Scan **Save** to save your selection.



BT_PIN.

Bluetooth PIN

Minimizing Bluetooth/ISM Band Network Activity

The settings described below can help you customize the relinking behavior of the cordless area-imaging system to obtain the best compromise between convenience and low interference.

Note: ISM band refers to the 2.4 to 2.48 GHz frequency band used by wireless networks, cordless phones, and Bluetooth.

Auto Reconnect Mode

Auto Reconnect controls whether or not the scanner automatically begins the relink process when a loss of connection is detected. When the **Auto Reconnect On** bar code is scanned, the scanner begins the relink process immediately, without user intervention. *Default = Auto Reconnect On.*



BT_ACM1.
* Auto Reconnect On



BT_ACM0.
Auto Reconnect Off

Note: If you are connecting to a Bluetooth Interface Module, set Auto Reconnect to Off.

The table below shows the results of the Auto Reconnect On and Off settings:

| Event | Auto Reconnect On | Auto Reconnect Off |
|--|---|--|
| Scanner out of range | Relink occurs automatically. If maximum number of link attempts is unsuccessful, then the scanner must be relinked by either pulling the trigger, placing the scanner in the base, or scanning the Access Point linking bar code. (See "Maximum Link Attempts" on page 3-24.) | The scanner is relinked by pulling the trigger, or scanning the Access Point linking bar code. |
| Base or Access point reset (firmware upgrade or power cycle) | Scanner behaves as if out of range. | No attempt to relink made while base or Access Point is powered off. Trigger must be pulled to initiate relinking. |
| Scanner power down due to Power Time-Out Timer setting (see page 4-7) | Trigger must be pulled, Access Point linking bar code must be scanned, or the scanner must be placed in the base unit to relink. (Note: scanner relinks on power up, but powers on due to one of the above actions.) | |
| Scanner reset due to firmware upgrade | Relink occurs automatically. | |
| Scanner reset due to battery change | Relink occurs automatically. | |
| Scanner placed in different base unit | Relink to new base occurs automatically. | |

Maximum Link Attempts

The Maximum Link Attempts setting controls the number of times the scanner tries to form a connection with a base or an Access Point. During the connection setup process, the scanner transmits in order to search for and connect to a base or an Access Point. In order to prevent continuous transmissions that could interfere with other users of the ISM band, the number of attempts to connect is limited by this setting. After the maximum number of attempts is reached, the scanner will not attempt to reconnect to a base or an Access Point. Pressing the trigger, scanning an Access Point linking bar code, or placing the scanner in the cradle resets the attempt count and the scanner will again try to link.

Scan the **Maximum Link Attempts** bar code, then scan the number of attempts for the setting (from 0-100) from the inside back cover. Scan Save to save the setting. *Default = 0.*



Note: When Auto Reconnect Mode is On, setting Maximum Link Attempts to zero will cause the scanner to try to link until the Power Time-Out Timer setting (see [page 3-11](#)) expires. When Auto Reconnect Mode is Off, setting Maximum Link Attempts to zero will cause the scanner to only attempt linking one time after a trigger pull.

Relink Time-Out

Relink Time-Out controls the idle time between relink attempts. An attempt to link a scanner to a base or an Access Point typically lasts up to 5 seconds. This is the time when the scanner is actually attempting a contact. Relink Time-Out controls the amount of time, in seconds, that elapses between the end of one connection attempt and the start of the next.

Note: The length of time for an attempt depends on the number of scanners connected to a base unit or Access Point. An extra 7 seconds may be required when a connection is successful.

Scan the **Relink Time-Out** bar code, then scan the number of seconds for the setting (from 1-100) from the inside back cover. Scan Save to save the setting. *Default = 3 seconds.*



Bluetooth/ISM Network Activity Examples

Default values

When the scanner goes out of range, the scanner repeatedly attempts to connect to the base unit or Access Point. Each attempt consists of approximately 5 seconds of active time followed by 3 seconds of idle time. After one hour, the scanner powers off and batch mode data is lost.

Maximum Link Attempts set to 15 Other values at default setting

When the scanner goes out of range, 15 attempts are made to link to the base unit or Access Point. Each attempt consists of approximately 5 seconds of active time followed by 3 seconds of idle time. After 15 cycles ($8 \times 15 = 120$), or about 2 minutes, the scanner stops trying to connect to the base or Access Point, but retains any bar codes that may have been saved in batch mode. After one hour, the scanner powers off and batch mode data is lost.

Auto Reconnect Mode set to 0 Maximum Link Attempts set to 15 Other values at default setting

When the scanner goes out of range, no action is taken to relink. When the trigger is pulled, 15 attempts are made to link to the base or Access Point. Each attempt consists of approximately 5 seconds of active time followed by 3 seconds of idle time. After 15 cycles ($8 \times 15 = 120$), or about 2 minutes, the scanner stops trying to connect to the base or Access Point, but retains any bar codes that may have been saved in batch mode. After one hour, the scanner powers off and batch mode data is lost. Refer to [Auto Reconnect Mode](#), page 3-24, to review other events that can start the relink process.

Auto Reconnect Mode set to 1 Maximum Link Attempts set to 0 Relink Time-Out set to 10 Scanner Power Time-Out Timer set to 1800

Note: See [Scanner Power Time-Out Timer](#) on page 3-11.

The scanner attempts to connect to the base or Access Point every 15 seconds, measured from one attempt start to the next attempt start. After one half hour, the scanner powers off.

Host Acknowledgment

Some applications require that the host terminal (or server) validate incoming bar code data (database look-up) and provide acknowledgement to the scanner whether or not to proceed. In Host ACK Mode, the scanner waits for this acknowledgement after each scan. Visual and audible acknowledgements provide valuable feedback to the scan operator. The Host ACK functionality is controlled via a number of pre-defined escape commands that are sent to the scanner to make it behave in different ways.

Note: System performance degrades when using Host ACK at rates lower than 9600 baud.

The following criteria must be met for the Host ACK to work correctly:

- The cordless system must be configured for Host Port RS232 (terminal ID = 000) or USB COM Emulation (terminal ID = 130).
- RTS/CTS is defaulted off. You must enable it if the host system requires it.
- Host ACK must be set to On ([page 3-27](#)).
- A comma must be used as a terminator.
- The host terminal software must be capable of interpreting the bar code data, make decisions based on the data content, and send out appropriate escape commands to the scanner.

Escape commands are addressed to the scanner via "Application Work Groups." Once a command is sent, all scanners in a group respond to that command. Because of this, **it is recommended that each scanner is assigned to its own group in Host ACK mode.**

The commands to which the scanner responds are listed on [page 3-27](#). The [ESC] is a 1B in hex. A typical command string is **y [ESC] x**, where "y" is the application work group number, "[ESC] x" is the escape command, and the comma is the terminator, which is required. (When "y" is not specified, the command is sent to the default Application Work Group 0.)

Example: Commands may be strung together to create custom response sequences. An example of a command string is listed below.

```
0[ESC]4,[ESC]5,[ESC]6,
```

The above example will make a scanner that is in application work group zero beep low, then medium, then high.

Example: A good read beep is required for any item on file, but a razz or error tone is required if the item is not on file. In this case,

```
[ESC]7, is sent to the host for an on-file product
```

```
[ESC]8,[ESC]8, is sent to the host for a not-on-file product
```

When a bar code is scanned, the scanner enters a timeout period until either the host ACK sequence is received, or the timeout expires (in 10 seconds, by default).

Once Host ACK is enabled, the system works as follows when a bar code is scanned:

- The scanner reads the code and sends data to the base or Access Point to transmit to the host system. No audible or visual indication is emitted until the scanner receives an escape command. The scanner read illumination goes out when there's a successful read.
- Scanner operation is suspended until 1) a valid escape string is received from the host system or 2) the scanner times out.
- Once condition 1 or 2 above has been met, the scanner is ready to scan again, and the process repeats.

A time-out occurs if the scanner does not receive a valid escape command within 10 seconds. A time-out is indicated by an error tone. If a time-out occurs, the operator should check the host system to understand why a response to the scanner was not received.

Host ACK On/Off



HSTACK1.
Host ACK On



HSTACK0.
* Host ACK Off

Host ACK Responses

| Command | Action |
|------------------|---|
| [ESC] a, | Double beeps to indicate a successful menu change was made. |
| [ESC] b, | Razz or error tone to indicate a menu change was unsuccessful. |
| [ESC] 1, | The green LED illuminates for 135 milliseconds followed by a pause. |
| [ESC] 2, | The green LED illuminates for 2 seconds followed by a pause. |
| [ESC] 3, | The green LED illuminates for 5 seconds followed by a pause. |
| [ESC] 4, | Emits a beep at a low pitch. |
| [ESC] 5, | Emits a beep at a medium pitch. |
| [ESC] 6, | Emits a beep at a high pitch. |
| [ESC] 7, | Beeps to indicate a successful decode and communication to host. |
| [ESC] 8,[ESC] 8, | Razz or error tone to indicate a decode/communication to host was unsuccessful. |



Input/Output Settings

Power Up Beeper

Note: This feature does not apply to the CCB02-100BT base.

The scanner can be programmed to beep when it's powered up. If you are using a cordless system, the base can also be programmed to beep when it is powered up. Scan the **Off** bar code(s) if you don't want a power up beep. *Default = Power Up Beeper On - Scanner.*



BEPPWR0.

**Power Up Beeper Off -
Scanner**



BEPPWR1.

*** Power Up Beeper On -
Scanner**



BASPWR0.

**Power Up Beeper Off -
Cordless Base**



BASPWR1.

**Power Up Beeper On -
Cordless Base**

Beep on BEL Character

You may wish to force the scanner to beep upon a command sent from the host. If you scan the **Beep on BEL On** bar code below, the scanner will beep every time a BEL character is received from the host. *Default = Beep on BEL Off.*



BELBEP0.

***Beep on BEL Off**



BELBEP1.

Beep on BEL On

Trigger Click

To hear an audible click every time the scanner trigger is pressed, scan the **Trigger Click On** bar code below. Scan the **Trigger Click Off** code if you don't wish to hear the click. (This feature has no effect on serial or automatic triggering.) *Default = Trigger Click Off.*



Good Read and Error Indicators

Beeper – Good Read

The beeper may be programmed **On** or **Off** in response to a good read. Turning this option off only turns off the beeper response to a good read indication. All error and menu beeps are still audible. *Default = Beeper - Good Read On.*



Beeper Volume – Good Read

The beeper volume codes modify the volume of the beep the scanner emits on a good read. *Default = High.*



Beeper Pitch – Good Read

The beeper pitch codes modify the pitch (frequency) of the beep the scanner emits on a good read. The Medium pitch differs for the Xenon and Granit scanners. *Default = Medium.*



Vibrate – Good Read

Note: Vibration settings apply only to Granit Devices.

The scanner vibrates once when a bar code is successfully read, and twice when a programming bar code is successfully read. When a programming bar code is unsuccessful, the scanner emits one long vibration (2 times the Vibrate Duration length). Scan **Vibrate - Good Read Off** to keep the scanner from vibrating. *Default = Vibrate - Good Read On.*



Vibrate Duration

If you want to set the length for the good read vibration, scan the bar code below, then set the duration (from 100 - 2,000 milliseconds) by scanning digits from the inside back cover, then scanning **Save**. *Default = 300 ms.*



Beeper Pitch – Error

The beeper pitch codes modify the pitch (frequency) of the sound the scanner emits when there is a bad read or error. *Default = Razz.*



BEPFQ2250.
* Razz (250 Hz)



BEPFQ23250.
Medium (3250 Hz)



BEPFQ24200.
High (4200 Hz)

Beeper Duration – Good Read

The beeper duration codes modify the length of the beep the scanner emits on a good read. *Default = Normal.*



BEPBIP0.
* Normal Beep



BEPBIP1.
Short Beep

LED – Good Read

The LED indicator can be programmed **On** or **Off** in response to a good read. *Default = On.*



BEPLED1.
* LED - Good Read On



BEPLED0.
LED - Good Read Off

Number of Beeps – Good Read

The number of beeps of a good read can be programmed from 1 - 9. The same number of beeps will be applied to the beeper and LED in response to a good read. For example, if you program this option to have five beeps, there will be five beeps and five LED flashes in response to a good read. The beeps and LED flashes are in sync with one another. To change the number of beeps, scan the bar code below and then scan a digit (1-9) bar code and the **Save** bar code on the [Programming Chart](#) inside the back cover of this manual. *Default = 1.*



BEPRPT.

Number of Good Read Beeps/LED Flashes

Number of Beeps – Error

The number of beeps and LED flashes emitted by the scanner for a bad read or error can be programmed from 1 - 9. For example, if you program this option to have five error beeps, there will be five error beeps and five LED flashes in response to an error. To change the number of error beeps, scan the bar code below and then scan a digit (1-9) bar code and the **Save** bar code on the [Programming Chart](#) inside the back cover of this manual. *Default = 1.*



BEPERR.

Number of Error Beeps/LED Flashes

Beeper Volume Max

Note: The Beeper Volume Max feature only applies to Granit products.

Scan the following bar code to set all error and good read beeps to the maximum volume. This feature also sets the [Beeper Pitch – Good Read](#) to the highest level.



PAPBLM.

Beeper Volume Max

Good Read Delay

This sets the minimum amount of time before the scanner can read another bar code. *Default = 0 ms (No Delay).*



DLYGRD0.

*** No Delay**



DLYGRD500.

Short Delay (500 ms)



DLYGRD1000.

Medium Delay (1,000 ms)



DLYGRD1500.
Long Delay (1,500 ms)

User-Specified Good Read Delay

If you want to set your own length for the good read delay, scan the bar code below, then set the delay (from 0 - 30,000 milliseconds) by scanning digits from the inside back cover, then scanning **Save**.



DLYGRD.
User-Specified Good Read Delay

Manual Trigger Modes

When in manual trigger mode, the scanner scans until a bar code is read, or until the trigger is released. Two modes are available, **Normal** and **Enhanced**. Normal mode offers good scan speed and the longest working ranges (depth of field). Enhanced mode will give you the highest possible scan speed but slightly less range than Normal mode. Enhanced mode is best used when you require a very fast scan speed and don't require a long working range. *Default = Manual Trigger-Normal.*



PAPHHF.
* Manual Trigger - Normal



PAPHHS.
Manual Trigger - Enhanced

LED Illumination - Manual Trigger

If you wish to set the illumination LED brightness, scan one of the bar codes below. This sets the LED illumination for the scanner when the trigger is pressed. *Default = High.*

Note: The Medium setting is not available on Granit devices.

The LEDs are like a flash on a camera. The lower the ambient light in the room, the brighter the LEDs need to be so the scanner can "see" the bar codes.



PWRNOLD.
Off



PWRNOL100.
Low



PWRNOL120.
Medium



PWRNOL150.

* High

Serial Trigger Mode

You can activate the scanner either by pressing the trigger, or using a serial trigger command (see [Trigger Commands](#) on page 11-3). When in serial mode, the scanner scans until a bar code has been read or until the deactivate command is sent. The scanner can also be set to turn itself off after a specified time has elapsed (see [Read Time-Out](#), which follows).

Read Time-Out

Use this selection to set a time-out (in milliseconds) of the scanner's trigger when using serial commands to trigger the scanner. Once the scanner has timed out, you can activate the scanner either by pressing the trigger or using a serial trigger command. After scanning the **Read Time-Out** bar code, set the time-out duration (from 0-300,000 milliseconds) by scanning digits on the [Programming Chart](#) inside the back cover, then scanning **Save**. *Default = 30,000 ms.*



TRGSTO.

Read Time-Out

Presentation Mode

Presentation Mode uses ambient light and scanner illumination to detect bar codes. When in Presentation Mode, the LEDs remain dim until a bar code is presented to the scanner, then the aimer turns on and the LEDs turn up to read the code. If the light level in the room is not high enough, Presentation Mode may not work properly.

Note: If you are using a cordless charge base in Presentation Mode, the battery will not charge unless the power supply is plugged into the base's auxiliary power port.

Scan the following bar code to program your scanner for Presentation Mode.



PAPTPR.

Presentation Mode

LED Illumination - Presentation Mode

If you wish to set the illumination LED brightness, scan one of the bar codes below. This sets the LED illumination for the scanner when it is in Presentation Mode. (If the scanner is triggered manually, the LED illumination will switch to the setting for a manual trigger. See "LED Illumination - Manual Trigger" on page 4-6.) *Default = High.*

Note: The LEDs are like a flash on a camera. The lower the ambient light in the room, the brighter the LEDs need to be so the scanner can "see" the bar codes.



PWRLDC0.
Off



PWRLDC100.
Low



PWRLDC150.
* High

Note: LED Illumination - Presentation Mode does not apply to [Streaming Presentation™ Mode](#) or [Mobile Phone Read Mode](#).

Presentation LED Behavior after Decode

When a scanner is in presentation mode, the LEDs dim 30 seconds after a bar code is decoded. If you wish to dim the LEDs immediately after a bar code is decoded, scan the **LEDs Off** bar code, below. *Default = LEDs On.*



TRGPCK1.
* LEDs On



TRGPCK0.
LEDs Off

Presentation Sensitivity

Presentation Sensitivity is a numeric range that increases or decreases the scanner's reaction time to bar code presentation. To set the sensitivity, scan the **Sensitivity** bar code, then scan the degree of sensitivity (from 0-20) from the inside back cover, and **Save**. 0 is the most sensitive setting, and 20 is the least sensitive. *Default = 1.*



TRGPMS.
Sensitivity

Presentation Centering

Use Presentation Centering to narrow the scanner's field of view when it is in the stand to make sure the scanner reads only those bar codes intended by the user. For instance, if multiple codes are placed closely together, Presentation Centering will insure that only the desired codes are read.

Note: To adjust centering when the scanner is hand-held, see [Centering](#) (page 4-16).

If a bar code is not touched by a predefined window, it will not be decoded or output by the scanner. If Presentation Centering is turned on by scanning **Presentation Centering On**, the scanner only reads codes that pass through the centering window you specify using the **Top of Presentation Centering Window**, **Bottom of Presentation Centering Window**, **Left**, and **Right of Presentation Centering Window** bar codes.

In the example below, the white box is the centering window. The centering window has been set to 20% left, 30% right, 8% top, and 25% bottom. Since Bar Code 1 passes through the centering window, it will be read. Bar Code 2 does not pass through the centering window, so it will not be read.

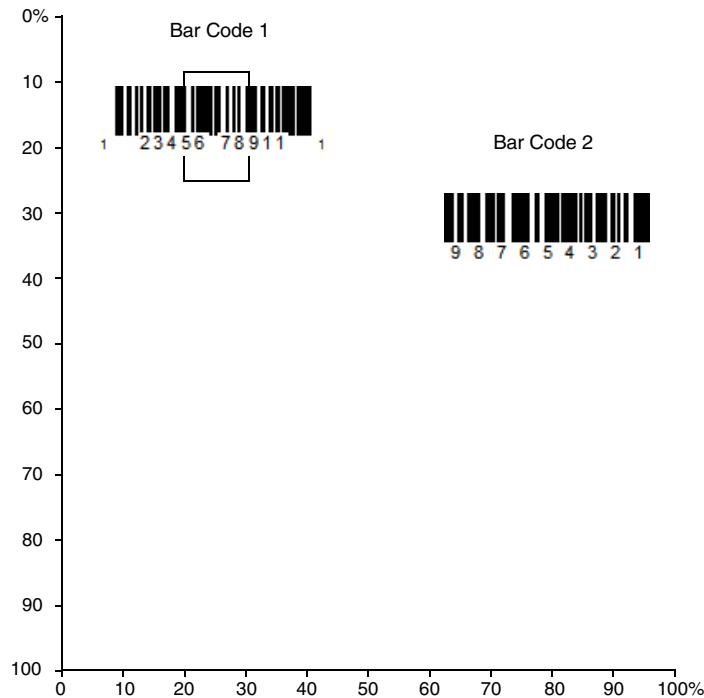

Note: A bar code needs only to be touched by the centering window in order to be read. It does not need to pass completely through the centering window.

Scan **Presentation Centering On**, then scan one of the following bar codes to change the top, bottom, left, or right of the centering window. Then scan the percent you want to shift the centering window using digits on the inside back cover of this manual. Scan **Save**. *Default Presentation Centering = 40% for Top and Left, 60% for Bottom and Right.*



PDCWIN1.
Presentation Centering On



PDCWIND.
*** Presentation Centering Off**



PDCTOP.
Top of Presentation Centering Window



In-Stand Sensor Mode

Note: The In-Stand Sensor feature only applies to Xenon products.

This feature senses when the scanner is removed from the stand and tells it to begin manual triggering. When **Sensor On** is enabled, the scanner defaults to Streaming Presentation Mode when it is in the stand, and to Manual Trigger Mode when it is removed from the stand. *Default = Sensor On.*



*Note: If you are taking images (see [Imaging Commands](#) beginning on page 8-1), you must set the In-Stand Sensor to **Off**.*

You may program a Streaming Presentation Mode (Normal, Enhanced, or Mobile Phone) you wish to use for in-stand scanning, and a Manual Trigger mode (Normal, Enhanced, or Mobile Phone) you wish to use for out-of-stand scanning. To do this, you must first scan the preferred Streaming Presentation mode (see below), then scan the Manual Trigger mode (see [page 4-6](#) and [page 4-11](#)) you want to use.

CodeGate[®]

When CodeGate is **On**, the trigger is used to allow decoded data to be transmitted to the host system. The scanner remains on, scanning and decoding bar codes, but the bar code data is not transmitted until the trigger is pressed. When CodeGate is **Off**, bar code data is transmitted when it is decoded. *Default = CodeGate Off Out-of-Stand.*





AOSCGD1.
CodeGate On
Out-of-Stand

Streaming Presentation™ Mode

When in Streaming Presentation mode, the scanner's aimer goes out after a short time, but the scan illumination remains on all the time to continuously search for bar codes. Two modes are available, **Normal** and **Enhanced**. Normal mode offers good scan speed and the longest working ranges (depth of field). Enhanced mode will give you the highest possible scan speed but slightly less range than Normal mode. Enhanced mode is best used when you require a very fast scan speed and don't require a long working range.



PAPSPN.
Streaming Presentation Mode
- Normal



PAPSPE.
Streaming Presentation Mode
- Enhanced

When using [Preferred Symbology](#) (page 4-18), a lower priority symbol must be centered on the aiming pattern to be read in Streaming Presentation Mode.

Note: If you are using a cordless charge base, it must have an external power supply plugged into the aux port for Streaming Presentation to work properly.

Streaming Presentation In-Stand Programming

This option is available when using [In-Stand Sensor Mode](#), page 4-10. You may program a specific Streaming Presentation Mode for in-stand scanning, and a Manual Trigger mode for out-of-stand scanning. To do this, you must first scan the preferred Streaming Presentation mode (Normal, Enhanced, or Mobile Phone), then scan the Manual Trigger mode (Normal, Enhanced, or Mobile Phone) you want to use.

Mobile Phone Read Mode

When this mode is selected, your scanner is optimized to read bar codes from mobile phone or other LED displays. However, the speed of scanning printed bar codes may be slightly lower when this mode is enabled. You can enable Mobile Phone Reading for either a hand held device, or for a hands-free (presentation) application.



PAPHHC.
Hand Held Scanning - Mobile
Phone



PAPSPC.
Streaming Presentation -
Mobile Phone

Note: To turn off Mobil Phone Read Mode, scan a Manual or Serial Trigger Mode bar code (see page 4-6).

Hands Free Time-Out

The Scan Stand and Presentation Modes are referred to as “hands free” modes. If the scanner’s trigger is pulled when using a hands free mode, the scanner changes to manual trigger mode. You can set the time the scanner should remain in manual trigger mode by setting the Hands Free Time-Out. Once the time-out value is reached, (if there have been no further trigger pulls) the scanner reverts to the original hands free mode.

Scan the **Hands Free Time-Out** bar code, then scan the time-out duration (from 0-300,000 milliseconds) from the inside back cover, and **Save**. *Default = 5,000 ms.*



TRGPTO.
Hands Free Time-Out

Reread Delay

This sets the time period before the scanner can read the *same* bar code a second time. Setting a reread delay protects against accidental rereads of the same bar code. Longer delays are effective in minimizing accidental rereads. Use shorter delays in applications where repetitive bar code scanning is required. Reread Delay only works when in a [Presentation Mode](#) (see page 4-7). *Default = Medium.*



DLYRRD500.
Short (500 ms)



DLYRRD750.
* Medium (750 ms)



DLYRRD1000.
Long (1000 ms)



DLYRRD2000.
Extra Long (2000 ms)

User-Specified Reread Delay

If you want to set your own length for the reread delay, scan the bar code below, then set the delay (from 0-30,000 milliseconds) by scanning digits from the inside back cover, then scanning **Save**.



DLYRRD.
User-Specified Reread Delay

2D Reread Delay

Sometimes 2D bar codes can take longer to read than other bar codes. If you wish to set a separate Reread Delay for 2D bar codes, scan one of the programming codes that follows. **2D Reread Delay Off** indicates that the time set for [Reread Delay](#) is used for both 1D and 2D bar codes. *Default = 2D Reread Delay Off.*



DLY2RR0.

* 2D Reread Delay Off



DLY2RR1000.

Short (1000ms)



DLY2RR2000.

Medium (2000ms)



DLY2RR3000.

Long (3000ms)



DLY2RR4000.

Extra Long (4000ms)

Character Activation Mode

You may use a character sent from the host to trigger the scanner to begin scanning. When the activation character is received, the scanner continues scanning until either the [Character Activation Timeout](#) (page 4-14), the deactivation character is received (see [Deactivation Character](#) on page 4-15), or a bar code is transmitted. Scan the following **On** bar code to use character activation, then use Activation Character (following) to select the character you will send from the host to start scanning. *Default = Off.*



HSTCEN0.

* Off



HSTCEN1.

On

Activation Character

This sets the character used to trigger scanning when using Character Activation Mode. On the [ASCII Conversion Chart \(Code Page 1252\)](#), page A-3, find the hex value that represents the character you want to use to trigger scanning. Scan the following bar code, then use the [Programming Chart](#) to read the alphanumeric combination that represents that ASCII character. Scan **Save** to finish. *Default = 12 [DC2].*



HSTACH.

Activation Character

End Character Activation After Good Read

After a bar code is successfully detected and read from the scanner, the illumination can be programmed either to remain on and scanning, or to turn off. When **End Character Activation After Good Read** is enabled, the illumination turns off and stops scanning after a good read. If you scan **Do Not End Character Activation After Good Read**, the illumination remains on after a good read. *Default = Do Not End Character Activation After Good Read.*



HSTCGD0.

* Do Not End Character
Activation After Good Read



HSTCGD1.

End Character Activation After
Good Read

Character Activation Timeout

You can set a timeout for the length of time the illumination remains on and attempting to decode bar codes when using Character Activation Mode. Set the length (in milliseconds) for a timeout by scanning the following bar code, then setting the timeout (from 1-300,000 milliseconds) by scanning digits from the [Programming Chart](#) inside the back cover of this manual, then scanning **Save**. *Default = 30,000 ms.*



HSTCDT.

Character Activation Timeout

Character Deactivation Mode

If you have sent a character from the host to trigger the scanner to begin scanning, you can also send a deactivation character to stop scanning. Scan the following **On** bar code to use character deactivation, then use Deactivation Character (following) to select the character you will send from the host to terminate scanning. *Default = Off.*



HSTDEND.

* Off



HSTDEN1.
On

Deactivation Character

This sets the character used to terminate scanning when using Character Deactivation Mode. On the [ASCII Conversion Chart \(Code Page 1252\)](#), page A-3, find the hex value that represents the character you want to use to terminate scanning. Scan the following bar code, then use the [Programming Chart](#) inside the back cover of this manual to read the alphanumeric combination that represents that ASCII character. Scan **Save** to finish. *Default = 14 [DC4].*



HSTDCH.
Deactivation Character

Illumination Lights

If you want the illumination lights on while reading a bar code, scan the **Lights On** bar code, below. However, if you want to turn just the lights off, scan the **Lights Off** bar code. *Default = Lights On.*

Note: This setting does not affect the aimer light. The aiming light can be set using [Aimer Mode](#) (page 4-16).



SCNLED1.
* Lights On



SCNLED0.
Lights Off

Aimer Delay

The aimer delay allows a delay time for the operator to aim the scanner before the picture is taken. Use these codes to set the time between when the trigger is pulled and when the picture is taken. During the delay time, the aiming light will appear, but the LEDs won't turn on until the delay time is over. *Default = Off.*



SCNDLY200.
200 milliseconds



SCNDLY400.
400 milliseconds



SCNDLY0.
* Off (no delay)

User-Specified Aimer Delay

If you want to set your own length for the duration of the delay, scan the bar code below, then set the time-out by scanning digits (0 - 4,000 ms) from the [Programming Chart](#) inside the back cover of this manual, then scan **Save**.



SCNDLY.

Delay Duration

Aimer Mode

This feature allows you to turn the aimer on and off. When the **Interlaced** bar code is scanned, the aimer is interlaced with the illumination LEDs. *Default = Interlaced.*



SCNAIM0.

Off



SCNAIM2.

* Interlaced

Centering

Use Centering to narrow the scanner's field of view to make sure that when the scanner is hand-held, it reads only those bar codes intended by the user. For instance, if multiple codes are placed closely together, centering will insure that only the desired codes are read. (Centering can be used in conjunction with [Aimer Delay](#), page 4-15, for the most error-free operation in applications where multiple codes are spaced closely together. Using the Aimer Delay and Centering features, the scanner can emulate the operation of older systems, such as linear laser bar code scanners.)

Note: To adjust centering when the scanner is in the stand, see [Presentation Centering](#) (page 4-8).

If a bar code is not touched by a predefined window, it will not be decoded or output by the scanner. If centering is turned on by scanning **Centering On**, the scanner only reads codes that pass through the centering window you specify using the **Top of Centering Window**, **Bottom of Centering Window**, **Left**, and **Right of Centering Window** bar codes.

In the example below, the white box is the centering window. The centering window has been set to 20% left, 30% right, 8% top, and 25% bottom. Since Bar Code 1 passes through the centering window, it will be read. Bar Code 2 does not pass through the centering window, so it will not be read.

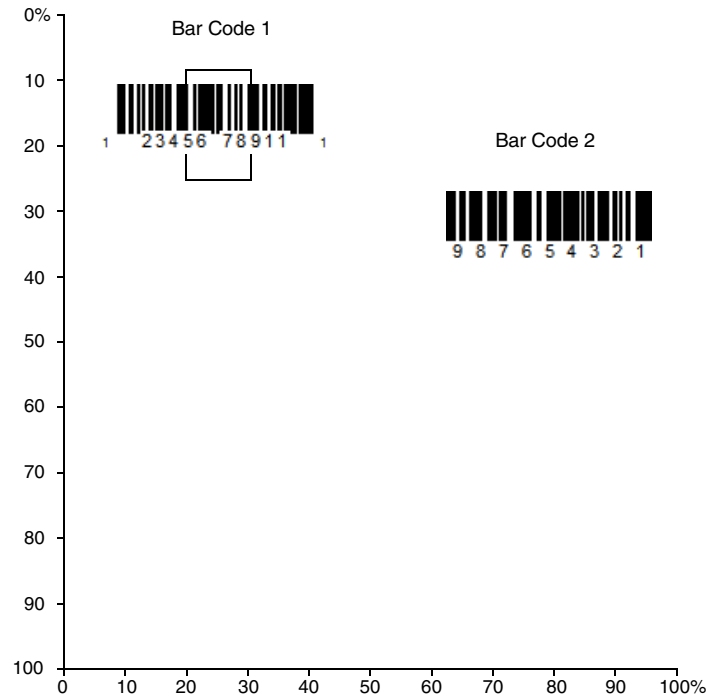

Note: A bar code needs only to be touched by the centering window in order to be read. It does not need to pass completely through the centering window.

Scan **Centering On**, then scan one of the following bar codes to change the top, bottom, left, or right of the centering window. Then scan the percent you want to shift the centering window using digits on the inside back cover of this manual. Scan **Save**.
Default Centering = 40% for Top and Left, 60% for Bottom and Right.





Preferred Symbology

The scanner can be programmed to specify one symbology as a higher priority over other symbologies in situations where both bar code symbologies appear on the same label, but the lower priority symbology cannot be disabled.

For example, you may be using the scanner in a retail setting to read U.P.C. symbols, but have occasional need to read a code on a drivers license. Since some licenses have a Code 39 symbol as well as the PDF417 symbol, you can use Preferred Symbology to specify that the PDF417 symbol be read instead of the Code 39.

Preferred Symbology classifies each symbology as **high priority**, **low priority**, or as an **unspecified type**. When a low priority symbology is presented, the scanner ignores it for a set period of time (see [Preferred Symbology Time-out](#) on page 4-19) while it searches for the high priority symbology. If a high priority symbology is located during this period, then that data is read immediately.

If the time-out period expires before a high priority symbology is read, the scanner will read any bar code in its view (low priority or unspecified). If there is no bar code in the scanner's view after the time-out period expires, then no data is reported.

Note: A low priority symbol must be centered on the aiming pattern to be read.

Scan a bar code below to enable or disable Preferred Symbology. *Default = Preferred Symbology Off.*



High Priority Symbology

To specify the high priority symbology, scan the High Priority Symbology bar code below. On the [Symbology Charts](#) on page A-1, find the symbology you want to set as high priority. Locate the Hex value for that symbology and scan the 2 digit hex value from the Programming Chart (inside back cover). Scan **Save** to save your selection. *Default = None*



Low Priority Symbology

To specify the low priority symbology, scan the Low Priority Symbology bar code below. On the [Symbology Charts](#) on page A-1, find the symbology you want to set as low priority. Locate the Hex value for that symbology and scan the 2 digit hex value from the Programming Chart (inside back cover).

If you want to set additional low priority symbologies, scan **FF**, then scan the 2 digit hex value from the Programming Chart for the next symbology. You can program up to 5 low priority symbologies. Scan **Save** to save your selection. *Default = None.*



Preferred Symbology Time-out

Once you have enabled Preferred Symbology and entered the high and low priority symbologies, you must set the time-out period. This is the period of time the scanner will search for a high priority bar code after a low priority bar code has been encountered. Scan the bar code below, then set the delay (from 1-3,000 milliseconds) by scanning digits from the inside back cover, then scanning **Save**. *Default = 500 ms.*



Preferred Symbology Default

Scan the bar code below to set all Preferred Symbology entries to their default values.



Output Sequence Overview

Output Sequence Editor

This programming selection allows you to program the scanner to output data (when scanning more than one symbol) in whatever order your application requires, regardless of the order in which the bar codes are scanned. Reading the **Default Sequence** symbol programs the scanner to the Universal values, shown below. These are the defaults. Be **certain** you want to delete or clear all formats before you read the **Default Sequence** symbol.

Note: To make Output Sequence Editor selections, you'll need to know the code I.D., code length, and character match(es) your application requires. Use the Alphanumeric symbols (inside back cover) to read these options. You must hold the trigger while reading each bar code in the sequence.

To Add an Output Sequence

1. Scan the **Enter Sequence** symbol (see [Require Output Sequence](#), page 4-21).
2. **Code I.D.**
On the [Symbology Charts](#) on page A-1, find the symbology to which you want to apply the output sequence format. Locate the Hex value for that symbology and scan the 2 digit hex value from the Programming Chart (inside back cover).
3. **Length**
Specify what length (up to 9999 characters) of data output will be acceptable for this symbology. Scan the four digit data length from the Programming Chart. (Note: 50 characters is entered as 0050. 9999 is a universal number, indicating all lengths.) When calculating the length, you must count any programmed prefixes, suffixes, or formatted characters as part of the length (unless using 9999).
4. **Character Match Sequences**
On the [ASCII Conversion Chart \(Code Page 1252\)](#), page A-3, find the Hex value that represents the character(s) you want to match. Use the Programming Chart to read the alphanumeric combination that represents the ASCII characters. (99 is the Universal number, indicating all characters.)

5. End Output Sequence Editor

Scan **FF** to enter an Output Sequence for an additional symbology, or **Save** to save your entries.

Other Programming Selections

- **Discard**
This exits without saving any Output Sequence changes.

Output Sequence Example

In this example, you are scanning Code 93, Code 128, and Code 39 bar codes, but you want the scanner to output Code 39 1st, Code 128 2nd, and Code 93 3rd, as shown below.

Note: Code 93 must be enabled to use this example.



A - Code 39



B - Code 128



C - Code 93

You would set up the sequence editor with the following command line:

```
SEQBLK62999941FF6A999942FF69999943FF
```

The breakdown of the command line is shown below:

SEQBLKsequence editor start command

```
62      code identifier for Code 39
9999    code length that must match for Code 39, 9999 = all lengths
41      start character match for Code 39, 41h = "A"
FF      termination string for first code
6A      code identifier for Code 128
9999    code length that must match for Code 128, 9999 = all lengths
42      start character match for Code 128, 42h = "B"
FF      termination string for second code
69      code identifier for Code 93
9999    code length that must match for Code 93, 9999 = all lengths
43      start character match for Code 93, 43h = "C"
FF      termination string for third code
```

To program the previous example using specific lengths, you would have to count any programmed prefixes, suffixes, or formatted characters as part of the length. If you use the example on [page 4-20](#), but assume a <CR> suffix and specific code lengths, you would use the following command line:

```
SEQBLK62001241FF6A001342FF69001243FF
```

The breakdown of the command line is shown below:

SEQBLKsequence editor start command

```
62      code identifier for Code 39
0012    A - Code 39 sample length (11) plus CR suffix (1) = 12
```

- 41 start character match for Code 39, 41h = "A"
- FF termination string for first code
- 6A code identifier for **Code 128**
- 0013 B - Code 128 sample length (12) plus CR suffix (1) = 13
- 42 start character match for Code 128, 42h = "B"
- FF termination string for second code
- 69 code identifier for **Code 93**
- 0012 C - Code 93 sample length (11) plus CR suffix (1) = 12
- 43 start character match for Code 93, 43h = "C"
- FF termination string for third code

Output Sequence Editor



Partial Sequence

If an output sequence operation is terminated before all your output sequence criteria are met, the bar code data acquired to that point is a "partial sequence."

Scan **Discard Partial Sequence** to discard partial sequences when the output sequence operation is terminated before completion. Scan **Transmit Partial Sequence** to transmit partial sequences. (Any fields in the sequence where no data match occurred will be skipped in the output.)



Require Output Sequence

When an output sequence is **Required**, all output data must conform to an edited sequence or the scanner will not transmit the output data to the host device. When it's **On/Not Required**, the scanner will attempt to get the output data to conform to an edited sequence but, if it cannot, the scanner transmits all output data to the host device as is.

When the output sequence is **Off**, the bar code data is output to the host as the scanner decodes it. *Default = Off.*

Note: This selection is unavailable when the Multiple Symbols Selection is turned on.



SEQ_EN2.
Required



SEQ_EN1.
On/Not Required



SEQ_EN0.
*Off

Multiple Symbols

When this programming selection is turned **On**, it allows you to read multiple symbols with a single pull of the scanner's trigger. If you press and hold the trigger, aiming the scanner at a series of symbols, it reads unique symbols once, beeping (if turned on) for each read. If using a Granit scanner, the scanner also vibrates. The scanner attempts to find and decode new symbols as long as the trigger is pulled. When this programming selection is turned **Off**, the scanner will only read the symbol closest to the aiming beam. *Default = Off.*



SHOTGN1.
On



SHOTGN0.
* Off

No Read

With No Read turned **On**, the scanner notifies you if a code cannot be read. If using an EZConfig-Scanning Tool Scan Data Window (see page 10-3), an "NR" appears when a code cannot be read. If No Read is turned **Off**, the "NR" will not appear. *Default = Off.*



SHWNRD1.
On



SHWNRD0.
* Off

If you want a different notation than "NR," for example, "Error," or "Bad Code," you can edit the output message (see [Data Formatting](#) beginning on page 6-1). The hex code for the No Read symbol is 9C.

Video Reverse

Video Reverse is used to allow the scanner to read bar codes that are inverted. The **Video Reverse Off** bar code below is an example of this type of bar code. Scan **Video Reverse Only** to read *only* inverted bar codes. Scan **Video Reverse and Standard Bar Codes** to read both types of codes.

*Note: After scanning **Video Reverse Only**, menu bar codes cannot be read. You must scan **Video Reverse Off** or **Video Reverse and Standard Bar Codes** in order to read menu bar codes.*

Note: Images downloaded from the unit are not reversed. This is a setting for decoding only.



VIDREV1.

Video Reverse Only



VIDREV2

Video Reverse and Standard Bar Codes



VIDREVO.

* Video Reverse Off

Working Orientation

Some bar codes are direction-sensitive. For example, KIX codes and OCR can misread when scanned sideways or upside down. Use the working orientation settings if your direction-sensitive codes will not usually be presented upright to the scanner. *Default = Upright.*

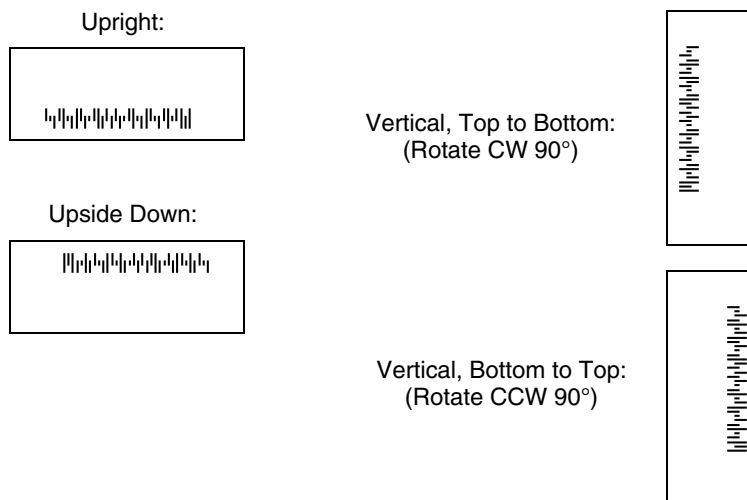



ROTATN0.
*** Upright**



ROTATN2.
Upside Down



ROTATN1.
Vertical, Bottom to Top



ROTATN3.
Vertical, Top to Bottom

Prefix/Suffix Overview

When a bar code is scanned, additional information is sent to the host computer along with the bar code data. This group of bar code data and additional, user-defined data is called a “message string.” The selections in this section are used to build the user-defined data into the message string.

Prefix and Suffix characters are data characters that can be sent before and after scanned data. You can specify if they should be sent with all symbologies, or only with specific symbologies. The following illustration shows the breakdown of a message string:

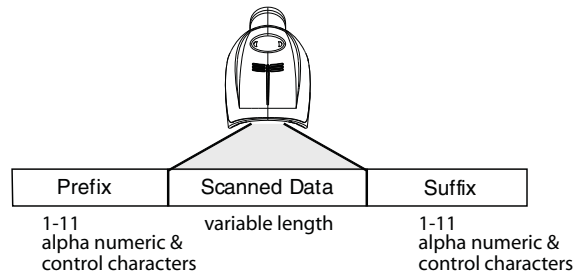

Points to Keep In Mind

- It is not necessary to build a message string. The selections in this chapter are only used if you wish to alter the default settings. *Default prefix = None. Default suffix = None.*
- A prefix or suffix may be added or cleared from one symbology or all symbologies.
- You can add any prefix or suffix from the [ASCII Conversion Chart \(Code Page 1252\)](#), beginning on page A-3, plus Code I.D. and AIM I.D.
- You can string together several entries for several symbologies at one time.
- Enter prefixes and suffixes in the order in which you want them to appear on the output.
- When setting up for specific symbologies (as opposed to all symbologies), the specific symbology ID value counts as an added prefix or suffix character.
- The maximum size of a prefix or suffix configuration is 200 characters, which includes header information.

To Add a Prefix or Suffix:

Step 1. Scan the **Add Prefix** or **Add Suffix** symbol ([page 5-2](#)).

Step 2. Determine the 2 digit Hex value from the Symbology Chart (included in the [Symbology Charts](#), beginning on page A-1) for the symbology to which you want to apply the prefix or suffix. For example, for Code 128, Code ID is “j” and Hex ID is “6A”.

Step 3. Scan the 2 hex digits from the [Programming Chart](#) inside the back cover of this manual or scan **9, 9** for all symbologies.

Step 4. Determine the hex value from the [ASCII Conversion Chart \(Code Page 1252\)](#), beginning on page A-3, for the prefix or suffix you wish to enter.

Step 5. Scan the 2 digit hex value from the [Programming Chart](#) inside the back cover of this manual.

Step 6. Repeat Steps 4 and 5 for every prefix or suffix character.

Step 7. To add the Code I.D., scan **5, C, 8, 0**.

To add AIM I.D., scan **5, C, 8, 1**.

To add a backslash (\), scan **5, C, 5, C**.

Note: To add a backslash (\) as in Step 7, you must scan 5C twice – once to create the leading backslash and then to create the backslash itself.

Step 8. Scan **Save** to exit and save, or scan **Discard** to exit without saving.

Repeat Steps 1-6 to add a prefix or suffix for another symbology.

Example: Add a Tab Suffix to All Symbologies

Step 1. Scan **Add Suffix**.

Step 2. Scan **9, 9** from the [Programming Chart](#) inside the back cover of this manual to apply this suffix to all symbologies.

Step 3. Scan **0, 9** from the [Programming Chart](#) inside the back cover of this manual. This corresponds with the hex value for a horizontal tab, shown in the [ASCII Conversion Chart \(Code Page 1252\)](#), beginning on page A-3.

Scan **Save**, or scan **Discard** to exit without saving.

To Clear One or All Prefixes or Suffixes

You can clear a single prefix or suffix, or clear all prefixes/suffixes for a symbology. If you have been entering prefixes and suffixes for single symbologies, you can use **Clear One Prefix (Suffix)** to delete a specific character from a symbology. When you **Clear All Prefixes (Suffixes)**, all the prefixes or suffixes for a symbology are deleted.

Step 1. Scan the **Clear One Prefix** or **Clear One Suffix** symbol.

Step 2. Determine the 2 digit Hex value from the Symbology Chart (included in the [Symbology Charts](#), beginning on page A-1) for the symbology from which you want to clear the prefix or suffix.

Step 3. Scan the 2 digit hex value from the [Programming Chart](#) inside the back cover of this manual or scan **9, 9** for all symbologies.

Your change is automatically saved.

To Add a Carriage Return Suffix to All Symbologies

Scan the following bar code if you wish to add a carriage return suffix to all symbologies at once. This action first clears all current suffixes, then programs a carriage return suffix for all symbologies.



VSUFCR.
Add CR Suffix
All Symbologies

Prefix Selections



PREBK2.
Add Prefix



PRECL2.
Clear One Prefix



PRECA2.
Clear All Prefixes

Suffix Selections



SUFBK2.
Add Suffix



Function Code Transmit

When this selection is enabled and function codes are contained within the scanned data, the scanner transmits the function code to the terminal. Charts of these function codes are provided in [Supported Interface Keys](#) starting on [page 9-3](#). When the scanner is in keyboard wedge mode, the scan code is converted to a key code before it is transmitted. *Default = Enable.*



Intercharacter, Interfunction, and Intermessage Delays

Some terminals drop information (characters) if data comes through too quickly. Intercharacter, interfunction, and intermessage delays slow the transmission of data, increasing data integrity.

Intercharacter Delay

An intercharacter delay of up to 5000 milliseconds (in 5ms increments) may be placed between the transmission of each character of scanned data. Scan the **Intercharacter Delay** bar code below, then scan the number of 5ms delays, and the **Save** bar code using the [Programming Chart](#) inside the back cover of this manual.

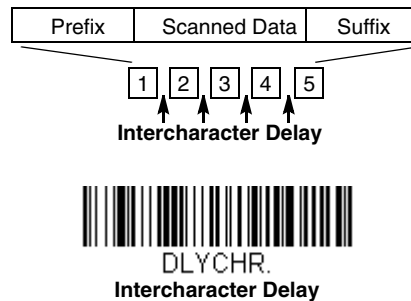

To remove this delay, scan the **Intercharacter Delay** bar code, then set the number of delays to 0. Scan the **Save** bar code using the [Programming Chart](#) inside the back cover of this manual.

Note: Intercharacter delays are not supported in USB serial emulation.

User Specified Intercharacter Delay

An intercharacter delay of up to 5000 milliseconds (in 5ms increments) may be placed after the transmission of a particular character of scanned data. Scan the **Delay Length** bar code below, then scan the number of 5ms delays, and the **Save** bar code using the [Programming Chart](#) inside the back cover of this manual.

Next, scan the **Character to Trigger Delay** bar code, then the 2-digit hex value for the ASCII character that will trigger the delay [ASCII Conversion Chart \(Code Page 1252\)](#), beginning on page A-3.



To remove this delay, scan the **Delay Length** bar code, and set the number of delays to 0. Scan the **Save** bar code using the [Programming Chart](#) inside the back cover of this manual.

Interfunction Delay

An interfunction delay of up to 5000 milliseconds (in 5ms increments) may be placed between the transmission of each control character in the message string. Scan the **Interfunction Delay** bar code below, then scan the number of 5ms delays, and the **Save** bar code using the [Programming Chart](#) inside the back cover of this manual.

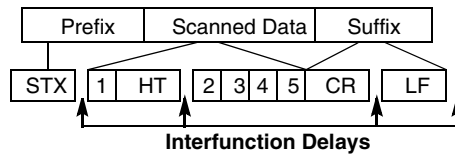

To remove this delay, scan the **Interfunction Delay** bar code, then set the number of delays to 0. Scan the **Save** bar code using the [Programming Chart](#) inside the back cover of this manual.

Intermessage Delay

An intermessage delay of up to 5000 milliseconds (in 5ms increments) may be placed between each scan transmission. Scan the **Intermessage Delay** bar code below, then scan the number of 5ms delays, and the **Save** bar code using the [Programming Chart](#) inside the back cover of this manual.

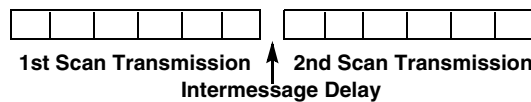

To remove this delay, scan the **Intermessage Delay** bar code, then set the number of delays to 0. Scan the **Save** bar code using the [Programming Chart](#) inside the back cover of this manual.

Data Formatting

Data Format Editor Introduction

You may use the Data Format Editor to change the scanner's output. For example, you can use the Data Format Editor to insert characters at certain points in bar code data as it is scanned. The selections in the following pages are used only if you wish to alter the output. *Default Data Format setting = None.*

Normally, when you scan a bar code, it is output automatically. However, when you create a format, you must use a "send" command (see [Send Commands](#) on page 6-3) within the format program to output data.

Multiple formats may be programmed into the scanner. They are stacked in the order in which they are entered. However, the following list presents the order in which formats are applied:

1. Specific Terminal ID, Actual Code ID, Actual Length
2. Specific Terminal ID, Actual Code ID, Universal Length
3. Specific Terminal ID, Universal Code ID, Actual Length
4. Specific Terminal ID, Universal Code ID, Universal Length
5. Universal Terminal ID, Actual Code ID, Actual Length
6. Universal Terminal ID, Actual Code ID, Universal Length
7. Universal Terminal ID, Universal Code ID, Actual Length
8. Universal Terminal ID, Universal Code ID, Universal Length

The maximum size of a data format configuration is 2000 bytes, which includes header information.

If a bar code is read that fails the first data format, the next data format, if there is one, will be used on the bar code data. If there is no other data format, the raw data is output.

If you have changed data format settings, and wish to clear all formats and return to the factory defaults, scan the **Default Data Format** code below.



Add a Data Format

Step 1. Scan the **Enter Data Format** symbol ([page 6-2](#)).

Step 2. Select **Primary/Alternate Format**

Determine if this will be your primary data format, or one of 3 alternate formats. This allows you to save a total of 4 different data formats. To program your primary format, scan **0** using the [Programming Chart](#) inside the back cover of this manual. If you are programming an alternate format, scan **1**, **2**, or **3**, depending on which alternate format you are programming. (See "Primary/Alternate Data Formats" on page 6-13 for further information.)

Step 3. Terminal Type

Refer to [Terminal ID Table](#) (page 6-3) and locate the Terminal ID number for your PC. Scan three numeric bar codes on the inside back cover to program the scanner for your terminal ID (you must enter 3 digits). For example, scan **0 0 3** for an AT wedge.

Note: 099 indicates all terminal types.

Step 4. Code I.D.

In the [Symbology Charts](#), beginning on page A-1, find the symbology to which you want to apply the data format. Locate the Hex value for that symbology and scan the 2 digit hex value from the [Programming Chart](#) inside the back cover of this manual.

If you wish to create a data format for all symbologies, with the exception of some specific symbologies, refer to B8 ([page 6-11](#)).

If you are creating a data format for Batch Mode Quantity, use 35 for the Code I.D.

Note: 99 indicates all symbologies.

Step 5. Length

Specify what length (up to 9999 characters) of data will be acceptable for this symbology. Scan the four digit data length from the [Programming Chart](#) inside the back cover of this manual. For example, 50 characters is entered as 0050.

Note: 9999 indicates all lengths.

Step 6. Editor Commands

Refer to [Data Format Editor Commands](#) (page 6-3). Scan the symbols that represent the command you want to enter.

Step 7. Scan **Save** to save your data format, or **Discard** to exit without saving your changes.



DFMBK3.

Enter Data Format



MNUSAV.

Save



MNUABT.

Discard

Other Programming Selections

Clear One Data Format

This deletes one data format for one symbology. If you are clearing the primary format, scan **0** from the [Programming Chart](#) inside the back cover of this manual. If you are clearing an alternate format, scan **1**, **2**, or **3**, depending on the format you are clearing. Scan the Terminal Type and Code I.D. (see [Symbology Charts](#) on page A-1), and the bar code data length for the specific data format that you want to delete. All other formats remain unaffected.

Clear all Data Formats

This clears all data formats.

Save to exit and save your data format changes.

Discard to exit without saving any data format changes.



DFMCL3.

Clear One Data Format



DFMCA3.

Clear All Data Formats



MNUSAV.

Save



MNUABT.

Discard

Terminal ID Table

| Terminal | Model(s) | Terminal ID |
|----------|------------------------------|-------------|
| USB | PC keyboard (HID) | 124 |
| | Mac Keyboard | 125 |
| | PC Keyboard (Japanese) | 134 |
| | Serial (COM driver required) | 130 |
| | HID POS | 131 |
| | USB SurePOS Handheld | 128 |
| | USB SurePOS Tabletop | 129 |
| Serial | RS232 TTL | 000 |
| | RS232 True | 000 |
| | RS485 (IBM-HHBCR 1+2, 46xx) | 051 |
| Keyboard | PS2 compatibles | 003 |
| | AT compatibles | 002 |

Data Format Editor Commands

When working with the Data Format Editor, a virtual cursor is moved along your input data string. The following commands are used to both move this cursor to different positions, and to select, replace, and insert data into the final output.

Send Commands

Send all characters

- F1 Include in the output message all of the characters from the input message, starting from current cursor position, followed by an insert character. *Syntax = F1xx* where xx stands for the insert character's hex value for its ASCII code. Refer to the [ASCII Conversion Chart \(Code Page 1252\)](#), beginning on page A-3 for decimal, hex and character codes.

Send a number of characters

- F2 Include in the output message a number of characters followed by an insert character. Start from the current cursor position and continue for "nn" characters or through the last character in the input message, followed by character "xx." *Syntax = F2nxx* where nn stands for the numeric value (00-99) for the number of characters, and xx stands for the insert character's hex value for its ASCII code. Refer to the [ASCII Conversion Chart \(Code Page 1252\)](#), beginning on page A-3 for decimal, hex and character codes.

F2 Example: Send a number of characters



Send the first 10 characters from the bar code above, followed by a carriage return. Command string: **F2100D**

F2 is the "Send a number of characters" command

10 is the number of characters to send

0D is the hex value for a CR

The data is output as: **1234567890**

F2 and F1 Example: Split characters into 2 lines

Send the first 10 characters from the bar code above, followed by a carriage return, followed by the rest of the characters.

Command string: **F2100DF10D**

F2 is the "Send a number of characters" command

10 is the number of characters to send for the first line

0D is the hex value for a CR

F1 is the "Send all characters" command

0D is the hex value for a CR

The data is output as:

1234567890
ABCDEFGHIJ
<CR>

Send all characters up to a particular character

- F3 Include in the output message all characters from the input message, starting with the character at the current cursor position and continuing to, but not including, the search character "ss," followed by an insert character. The cursor is moved forward to the "ss" character. *Syntax = F3ssxx* where ss stands for the search character's hex value for its ASCII code, and xx stands for the insert character's hex value for its ASCII code. Refer to the [ASCII Conversion Chart \(Code Page 1252\)](#), beginning on page A-3 for decimal, hex and character codes.

F3 Example: Send all characters up to a particular character



Using the bar code above, send all characters up to but not including "D," followed by a carriage return.

Command string: **F3440D**

F3 is the "Send all characters up to a particular character" command

44 is the hex value for a 'D'

0D is the hex value for a CR

The data is output as:

1234567890ABC
<CR>

Send all characters up to a string

- B9 Include in the output message all characters from the input message, starting with the character at the current cursor position and continuing to, but not including, the search string "s...s." The cursor is moved forward to the beginning of the "s...s" string. *Syntax = B9nnns...s* where nnnn stands for the length of the string, and s...s stands for the string to be matched. The string is made up of hex values for the characters in the string. Refer to the [ASCII Conversion Chart \(Code Page 1252\)](#), beginning on page A-3 for decimal, hex and character codes.

B9 Example: Send all characters up to a defined string



Using the bar code above, send all characters up to but not including "AB."

Command string: **B900024142**

B9 is the "Send all characters up to a string" command

0002 is the length of the string (2 characters)

41 is the hex value for A

42 is the hex value for B

The data is output as: **1234567890**

Send all but the last characters

- E9 Include in the output message all but the last "nn" characters, starting from the current cursor position. The cursor is moved forward to one position past the last input message character included. *Syntax = E9nn* where nn stands for the numeric value (00-99) for the number of characters that will not be sent at the end of the message.

Insert a character multiple times

- F4 Send “xx” character “nn” times in the output message, leaving the cursor in the current position. *Syntax = F4xxnn* where xx stands for the insert character’s hex value for its ASCII code, and nn is the numeric value (00-99) for the number of times it should be sent. Refer to the [ASCII Conversion Chart \(Code Page 1252\)](#), beginning on page A-3 for decimal, hex and character codes.

E9 and F4 Example: Send all but the last characters, followed by 2 tabs



Send all characters except for the last 8 from the bar code above, followed by 2 tabs.

Command string: **E908F40902**

E9 is the “Send all but the last characters” command

08 is the number of characters at the end to ignore

F4 is the “Insert a character multiple times” command

09 is the hex value for a horizontal tab

02 is the number of times the tab character is sent

The data is output as: **1234567890AB <tab><tab>**

Insert a string

- BA Send “ss” string of “nn” length in the output message, leaving the cursor in the current position. *Syntax = BAnnnns...s* where nnnn stands for the length of the string, and s...s stands for the string. The string is made up of hex values for the characters in the string. Refer to the [ASCII Conversion Chart \(Code Page 1252\)](#), beginning on page A-3 for decimal, hex and character codes.

B9 and BA Example: Look for the string “AB” and insert 2 asterisks ()**



Using the bar code above, send all characters up to but not including “AB.” Insert 2 asterisks at that point, and send the rest of the data with a carriage return after.

Command string: **B900024142BA00022A2AF10D**

B9 is the “Send all characters up to a string” command

0002 is the length of the string (2 characters)

41 is the hex value for A

42 is the hex value for B

BA is the “Insert a string” command

0002 is the length of the string to be added (2 characters)

2A is the hex value for an asterisk (*)

2A is the hex value for an asterisk (*)

F1 is the “Send all characters” command

0D is the hex value for a CR

The data is output as:

1234567890ABCDEFGHIJ
<CR>**

Insert symbology name

- B3 Insert the name of the bar code’s symbology in the output message, without moving the cursor. Only symbologies with a Honeywell ID are included (see [Symbology Charts](#) on page A-1). Refer to the [ASCII Conversion Chart \(Code Page 1252\)](#), beginning on page A-3 for decimal, hex and character codes.

Insert bar code length

- B4 Insert the bar code's length in the output message, without moving the cursor. The length is expressed as a numeric string and does not include leading zeroes.

B3 and B4 Example: Insert the symbology name and length



Send the symbology name and length before the bar code data from the bar code above. Break up these insertions with spaces. End with a carriage return.

Command string: **B3F42001B4F42001F10D**

B3 is the "Insert symbology name" command

F4 is the "Insert a character multiple times" command

20 is the hex value for a space

01 is the number of times the space character is sent

B4 is the "Insert bar code length" command

F4 is the "Insert a character multiple times" command

20 is the hex value for a space

01 is the number of times the space character is sent

F1 is the "Send all characters" command

0D is the hex value for a CR

The data is output as:

**Code128 20 1234567890ABCDEFGHIJ
<CR>**

Insert key strokes

- B5 Insert a key stroke or combination of key strokes. Key strokes are dependent on your keyboard (see [Unicode Key Maps](#) on page A-10). Any key can be inserted, including arrows and functions. *Syntax = B5xxssnn* where xx is the number of keys pressed (without key modifiers), ss is the key modifier from the table below, and nn is the key number from the [Unicode Key Maps](#), page A-10.

| Key Modifiers | |
|----------------------|----|
| No Key Modifier | 00 |
| Shift Left | 01 |
| Shift Right | 02 |
| Alt Left | 04 |
| Alt Right | 08 |
| Control Left | 10 |
| Control Right | 20 |

For example, B501021F inserts an "A" on a 104 key, U.S. style keyboard. B5 = the command, 01 = number of keys pressed (without the key modifier), 02 is the key modifier for Shift Right, and 1F is the "a" key. If a lower case "a" were to be inserted, B501001F would be entered.

If there are three keystrokes, the syntax would change from B5xxssnn for one keystroke to B5xxssnnssnnssnn. An example that would insert "abc" is as follows: B503001F00320030F833.

Note: Key modifiers can be added together when needed. Example: Control Left+Shift Left = 11.

Move Commands

Move the cursor forward a number of characters

- F5 Move the cursor ahead "nn" characters from current cursor position.
Syntax = F5nn where nn is the numeric value (00-99) for the number of characters the cursor should be moved ahead.

F5 Example: Move the cursor forward and send the data



Move the cursor forward 3 characters, then send the rest of the bar code data from the bar code above. End with a carriage return.

Command string: **F503F10D**

F5 is the "Move the cursor forward a number of characters" command

03 is the number of characters to move the cursor

F1 is the "Send all characters" command

0D is the hex value for a CR

The data is output as:

4567890ABCDEFGHIJ

<CR>

Move the cursor backward a number of characters

- F6 Move the cursor back "nn" characters from current cursor position. *Syntax = F6nn* where nn is the numeric value (00-99) for the number of characters the cursor should be moved back.

Move the cursor to the beginning

- F7 Move the cursor to the first character in the input message. *Syntax = F7.*

FE and F7 Example: Manipulate bar codes that begin with a 1



Search for bar codes that begin with a 1. If a bar code matches, move the cursor back to the beginning of the data and send 6 characters followed by a carriage return. Using the bar code above:

Command string: **FE31F7F2060D**

FE is the "Compare characters" command

31 is the hex value for 1

F7 is the "Move the cursor to the beginning" command

F2 is the "Send a number of characters" command

06 is the number of characters to send

0D is the hex value for a CR

The data is output as:

123456

<CR>

Move the cursor to the end

- EA Move the cursor to the last character in the input message. *Syntax = EA.*

Search Commands

Search forward for a character

- F8 Search the input message forward for "xx" character from the current cursor position, leaving the cursor pointing to the "xx" character. *Syntax = F8xx* where xx stands for the search character's hex value for its ASCII code. Refer to the [ASCII Conversion Chart \(Code Page 1252\)](#), beginning on page A-3 for decimal, hex and character codes.

F8 Example: Send bar code data that starts after a particular character



Search for the letter “D” in bar codes and send all the data that follows, including the “D.” Using the bar code above:

Command string: **F844F10D**

F8 is the “Search forward for a character” command

44 is the hex value for “D”

F1 is the “Send all characters” command

0D is the hex value for a CR

The data is output as:

DEFGHIJ

<CR>

Search backward for a character

- F9 Search the input message backward for “xx” character from the current cursor position, leaving the cursor pointing to the “xx” character. *Syntax = F9xx* where xx stands for the search character’s hex value for its ASCII code. Refer to the [ASCII Conversion Chart \(Code Page 1252\)](#), beginning on page A-3 for decimal, hex and character codes.

Search forward for a string

- B0 Search forward for “s” string from the current cursor position, leaving cursor pointing to “s” string. *Syntax = B0nnnnS* where nnnn is the string length (up to 9999), and S consists of the ASCII hex value of each character in the match string. For example, B0000454657374 will search forward for the first occurrence of the 4 character string “Test.” Refer to the [ASCII Conversion Chart \(Code Page 1252\)](#), beginning on page A-3 for decimal, hex and character codes.

B0 Example: Send bar code data that starts after a string of characters



Search for the letters “FGH” in bar codes and send all the data that follows, including “FGH.” Using the bar code above:

Command string: **B00003464748F10D**

B0 is the “Search forward for a string” command

0003 is the string length (3 characters)

46 is the hex value for “F”

47 is the hex value for “G”

48 is the hex value for “H”

F1 is the “Send all characters” command

0D is the hex value for a CR

The data is output as:

FGHIJ

<CR>

Search backward for a string

- B1 Search backward for “s” string from the current cursor position, leaving cursor pointing to “s” string. *Syntax = B1nnnnS* where nnnn is the string length (up to 9999), and S consists of the ASCII hex value of each character in the match string. For example, B1000454657374 will search backward for the first occurrence of the 4 character string “Test.” Refer to the [ASCII Conversion Chart \(Code Page 1252\)](#), beginning on page A-3 for decimal, hex and character codes.

Search forward for a non-matching character

- E6 Search the input message forward for the first non-“xx” character from the current cursor position, leaving the cursor pointing to the non-“xx” character. *Syntax = E6xx* where xx stands for the search character’s hex value for its ASCII code. Refer to the [ASCII Conversion Chart \(Code Page 1252\)](#), beginning on page A-3 for decimal, hex and character codes.

E6 Example: Remove zeroes at the beginning of bar code data



This example shows a bar code that has been zero filled. You may want to ignore the zeroes and send all the data that follows. E6 searches forward for the first character that is not zero, then sends all the data after, followed by a carriage return. Using the bar code above:

Command string: **E630F10D**

E6 is the “Search forward for a non-matching character” command

30 is the hex value for 0

F1 is the “Send all characters” command

0D is the hex value for a CR

The data is output as:

37692

<CR>

Search backward for a non-matching character

- E7 Search the input message backward for the first non-“xx” character from the current cursor position, leaving the cursor pointing to the non-“xx” character. *Syntax = E7xx* where xx stands for the search character’s hex value for its ASCII code. Refer to the [ASCII Conversion Chart \(Code Page 1252\)](#), beginning on page A-3 for decimal, hex and character codes.

Miscellaneous Commands

Suppress characters

- FB Suppress all occurrences of up to 15 different characters, starting at the current cursor position, as the cursor is advanced by other commands. When the FC command is encountered, the suppress function is terminated. The cursor is not moved by the FB command.
Syntax = FBnnxxyy . .zz where nn is a count of the number of suppressed characters in the list, and xxyy .. zz is the list of characters to be suppressed.

FB Example: Remove spaces in bar code data



This example shows a bar code that has spaces in the data. You may want to remove the spaces before sending the data. Using the bar code above:

Command string: **FB0120F10D**

FB is the “Suppress characters” command

01 is the number of character types to be suppressed

20 is the hex value for a space

F1 is the “Send all characters” command

0D is the hex value for a CR

The data is output as:

34567890

<CR>

Stop suppressing characters

FC Disables suppress filter and clear all suppressed characters. *Syntax = FC.*

Replace characters

E4 Replaces up to 15 characters in the output message, without moving the cursor. Replacement continues until the E5 command is encountered. *Syntax = E4nnxx₁xx₂yy₁yy₂...zz₁zz₂* where nn is the total count of the number of characters in the list (characters to be replaced plus replacement characters); xx₁ defines characters to be replaced and xx₂ defines replacement characters, continuing through zz₁ and zz₂.

E4 Example: Replace zeroes with CRs in bar code data



If the bar code has characters that the host application does not want included, you can use the E4 command to replace those characters with something else. In this example, you will replace the zeroes in the bar code above with carriage returns.

Command string: **E402300DF10D**

E4 is the “Replace characters” command

02 is the total count of characters to be replaced, plus the replacement characters (0 is replaced by CR, so total characters = 2)

30 is the hex value for 0

0D is the hex value for a CR (the character that will replace the 0)

F1 is the “Send all characters” command

0D is the hex value for a CR

The data is output as:

1234
5678
ABC
<CR>

Stop replacing characters

E5 Terminates character replacement. *Syntax = E5.*

Compare characters

FE Compare the character in the current cursor position to the character “xx.” If characters are equal, move the cursor forward one position. *Syntax = FExx* where xx stands for the comparison character’s hex value for its ASCII code. Refer to the [ASCII Conversion Chart \(Code Page 1252\)](#), beginning on page A-3 for decimal, hex and character codes.

Compare string

B2 Compare the string in the input message to the string “s.” If the strings are equal, move the cursor forward past the end of the string. *Syntax = B2nnnnS* where nnnn is the string length (up to 9999), and S consists of the ASCII hex value of each character in the match string. For example, B2000454657374 will compare the string at the current cursor position with the 4 character string “Test.” Refer to the [ASCII Conversion Chart \(Code Page 1252\)](#), beginning on page A-3 for decimal, hex and character codes.

Check for a number

EC Check to make sure there is an ASCII number at the current cursor position. The format is aborted if the character is not numeric.

EC Example: Only output the data if the bar code begins with a number

If you want only data from bar codes that begin with a number, you can use EC to check for the number.

Command string: **ECF10D**

EC is the “Check for a number” command

F1 is the “Send all characters” command

0D is the hex value for a CR

If this bar code is read,  the next data format, if there is one, will be used on the data. If there is no other format, the format fails and the raw data is output as **AB1234**.

If this bar code is read:  the data is output as:

1234AB
<CR>

Check for non-numeric character

ED Check to make sure there is a non-numeric ASCII character at the current cursor position. The format is aborted if the character is numeric.

ED Example: Only output the data if the bar code begins with a letter

If you want only data from bar codes that begin with a letter, you can use ED to check for the letter.

Command string: **EDF10D**

ED is the “Check for a non-numeric character” command

F1 is the “Send all characters” command

0D is the hex value for a CR

If this bar code is read,  the next data format, if there is one, will be used on this data. If there is no other format, the format fails and the raw data is output as **1234AB**.

If this bar code is read:  the data is output as:

AB1234
<CR>

Insert a delay

EF Inserts a delay of up to 49,995 milliseconds (in multiples of 5), starting from the current cursor position. Syntax = EFnnnn where nnnn stands for the delay in 5ms increments, up to 9999. This command can only be used with keyboard emulation.a

Discard Data

B8 Discards types of data. For example, you may want to discard Code 128 bar codes that begin with the letter A. In step 4 ([page 6-1](#)), select 6A (for Code 128), and in step 5, select 9999 (for all lengths). Enter FE41B8 to compare and discard Code 128 bar codes that begin with the letter A. *Syntax = B8.*

Note: The B8 command must be entered after all other commands.

*The Data Format must be **Required** (see [page 6-12](#)) in order for the B8 command to work.*

*If Data Format is **On, but Not Required** ([page 6-12](#)), bar code data that meets the B8 format is scanned and output as usual.*

*Because the data format needs to be **On and Required** ([page 6-12](#)) for the B8 command, you must input data formats for all bar codes you wish to discard as well as all bar codes you wish to output.*

*Other data format settings impact the B8 command. If Data Format Non-Match Error Tone is **On** ([page 6-13](#)), the scanner emits an error tone. If Data format Non-Match Error Tone is **Off**, the code is disabled for reading and no tone is sounded.*

Data Formatter

When Data Formatter is turned Off, the bar code data is output to the host as read, including prefixes and suffixes.



You may wish to require the data to conform to a data format you have created and saved. The following settings can be applied to your data format:

Data Formatter On, Not Required, Keep Prefix/Suffix

Scanned data is modified according to your data format, and prefixes and suffixes are transmitted.

Data Formatter On, Not Required, Drop Prefix/Suffix

Scanned data is modified according to your data format. If a data format is found for a particular symbol, those prefixes and suffixes are not transmitted. If a data format is *not* found for that symbol, the prefixes and suffixes *are* transmitted.

Data Format Required, Keep Prefix/Suffix

Scanned data is modified according to your data format, and prefixes and suffixes are transmitted. Any data that does not match your data format requirements generates an error tone and the data in that bar code is not transmitted. If you wish to process this type of bar code without generating an error tone, see [Data Format Non-Match Error Tone](#).

Data Format Required, Drop Prefix/Suffix

Scanned data is modified according to your data format. If a data format is found for a particular symbol, those prefixes and suffixes are not transmitted. Any data that does not match your data format requirements generates an error tone. If you wish to process this type of bar code without generating an error tone, see [Data Format Non-Match Error Tone](#).

Choose one of the following options. *Default = Data Formatter On, Not Required, Keep Prefix/Suffix.*



Data Format Non-Match Error Tone

When a bar code is encountered that doesn't match your required data format, the scanner normally generates an error tone. However, you may want to continue scanning bar codes without hearing the error tone. If you scan the **Data Format Non-Match Error Tone Off** bar code, data that doesn't conform to your data format is not transmitted, and no error tone will sound. If you wish to hear the error tone when a non-matching bar code is found, scan the **Data Format Non-Match Error Tone On** bar code. *Default = Data Format Non-Match Error Tone On.*



DFMDECO.

* Data Format Non-Match Error Tone On



DFMDEC1.

Data Format Non-Match Error Tone Off

Primary/Alternate Data Formats

You can save up to four data formats, and switch between these formats. Your primary data format is saved under **0**. Your other three formats are saved under **1**, **2**, and **3**. To set your device to use one of these formats, scan one of the bar codes below.



ALTFNMO.

Primary Data Format



ALTFNM1.

Data Format 1



ALTFNM2.

Data Format 2



ALTFNM3.

Data Format 3

Single Scan Data Format Change

You can also switch between data formats for a single scan. The next bar code is scanned using an alternate data format, then reverts to the format you have selected above (either Primary, 1, 2, or 3).

For example, you may have set your device to the data format you saved as Data Format 3. You can switch to Data Format 1 for a single trigger pull by scanning the **Single Scan-Data Format 1** bar code below. The next bar code that is scanned uses Data Format 1, then reverts back to Data Format 3.



VSAF_0.
**Single Scan-Primary
Data Format**



VSAF_2.
Single Scan-Data Format 2



VSAF_1.
Single Scan-Data Format 1



VSAF_3.
Single Scan-Data Format 3

Symbologies

This programming section contains the following menu selections. Refer to [Chapter 11](#) for settings and defaults.

- All Symbologies
- Aztec Code
- China Post (Hong Kong 2 of 5)
- Chinese Sensible (Han Xin) Code
- Codabar
- Codablock A
- Codablock F
- Code 11
- Code 128
- Code 32 Pharmaceutical (PARAF)
- Code 39
- Code 93
- Data Matrix
- EAN/JAN-13
- EAN/JAN-8
- GS1 Composite Codes
- GS1 DataBar Expanded
- GS1 DataBar Limited
- GS1 DataBar Omnidirectional
- GS1 Emulation
- GS1-128
- Interleaved 2 of 5
- Korea Post
- Matrix 2 of 5
- MaxiCode
- MicroPDF417
- MSI
- NEC 2 of 5
- Postal Codes - 2D
- Postal Codes - Linear
- PDF417
- GS1 DataBar Omnidirectional
- QR Code
- Straight 2 of 5 IATA (two-bar start/stop)
- Straight 2 of 5 Industrial (three-bar start/stop)
- TCIF Linked Code 39 (TLC39)
- Telepen
- Trioptic Code
- UPC-A
- UPC-A/EAN-13 with Extended Coupon Code
- UPC-E0
- UPC-E1

All Symbologies

If you want to decode all the symbologies allowable for your scanner, scan the **All Symbologies On** code. If on the other hand, you want to decode only a particular symbology, scan **All Symbologies Off** followed by the On symbol for that particular symbology.



ALLENA1.
All Symbologies On



ALLENA0.
All Symbologies Off

Note: When All Symbologies On is scanned, 2D Postal Codes are not enabled. 2D Postal Codes must be enabled separately.

Message Length Description

You are able to set the valid reading length of some of the bar code symbologies. If the data length of the scanned bar code doesn't match the valid reading length, the scanner will issue an error tone. You may wish to set the same value for minimum and maximum length to force the scanner to read fixed length bar code data. This helps reduce the chances of a misread.

EXAMPLE: Decode only those bar codes with a count of 9-20 characters.
Min. length = 09Max. length = 20

EXAMPLE: Decode only those bar codes with a count of 15 characters.
Min. length = 15Max. length = 15

For a value other than the minimum and maximum message length defaults, scan the bar codes included in the explanation of the symbology, then scan the digit value of the message length and **Save** bar codes on the [Programming Chart](#) inside the back cover of this manual. The minimum and maximum lengths and the defaults are included with the respective symbologies.

Codabar

<Default All Codabar Settings>



Codabar On/Off



Codabar Start/Stop Characters

Start/Stop characters identify the leading and trailing ends of the bar code. You may either transmit, or not transmit Start/Stop characters. *Default = Don't Transmit.*



Codabar Check Character

Codabar check characters are created using different "modulos." You can program the scanner to read only Codabar bar codes with Modulo 16 check characters. *Default = No Check Character.*

No Check Character indicates that the scanner reads and transmits bar code data with or without a check character.

When Check Character is set to **Validate and Transmit**, the scanner will only read Codabar bar codes printed with a check character, and will transmit this character at the end of the scanned data.

When Check Character is set to **Validate, but Don't Transmit**, the unit will only read Codabar bar codes printed **with** a check character, but will not transmit the check character with the scanned data.





Codabar Concatenation

Codabar supports symbol concatenation. When you enable concatenation, the scanner looks for a Codabar symbol having a “D” start character, adjacent to a symbol having a “D” stop character. In this case the two messages are concatenated into one with the “D” characters omitted.



Select Require to prevent the scanner from decoding a single “D” Codabar symbol without its companion. This selection has no effect on Codabar symbols without Stop/Start D characters.



Codabar Message Length

Scan the bar codes below to change the message length. Refer to [Message Length Description](#) (page 7-1) for additional information. Minimum and Maximum lengths = 2-60. Minimum Default = 4, Maximum Default = 60.



Code 39

< Default All Code 39 Settings >



Code 39 On/Off



Code 39 Start/Stop Characters

Start/Stop characters identify the leading and trailing ends of the bar code. You may either transmit, or not transmit Start/Stop characters. *Default = Don't Transmit.*



Code 39 Check Character

No Check Character indicates that the scanner reads and transmits bar code data with or without a check character.

When Check Character is set to **Validate, but Don't Transmit**, the unit only reads Code 39 bar codes printed with a check character, but will not transmit the check character with the scanned data.

When Check Character is set to **Validate and Transmit**, the scanner only reads Code 39 bar codes printed with a check character, and will transmit this character at the end of the scanned data. *Default = No Check Character.*



Code 39 Message Length

Scan the bar codes below to change the message length. Refer to [Message Length Description](#) (page 7-1) for additional information. Minimum and Maximum lengths = 0-48. Minimum Default = 0, Maximum Default = 48.



C39MIN.

Minimum Message Length



C39MAX.

Maximum Message Length

Code 39 Append

This function allows the scanner to append the data from several Code 39 bar codes together before transmitting them to the host computer. When the scanner encounters a Code 39 bar code with the append trigger character(s), it buffers Code 39 bar codes until it reads a Code 39 bar code that does not have the append trigger. The data is then transmitted in the order in which the bar codes were read (FIFO). *Default = Off.*



C39APP1.

On



C39APP0.

* Off

Code 32 Pharmaceutical (PARAF)

Code 32 Pharmaceutical is a form of the Code 39 symbology used by Italian pharmacies. This symbology is also known as PARAF.

Note: Trioptic Code (page 7-32) must be turned off while scanning Code 32 Pharmaceutical codes.



C39B321.

On



C39B320.

* Off

Full ASCII

If Full ASCII Code 39 decoding is enabled, certain character pairs within the bar code symbol will be interpreted as a single character. For example: \$V will be decoded as the ASCII character SYN, and /C will be decoded as the ASCII character #. *Default = Off.*

| | | | | | | | |
|---------|---------|----------|------|------|------|------|--------|
| NUL %U | DLE \$P | SP SPACE | 0 0 | @ %V | P P | ' %W | p +P |
| SOH \$A | DC1 \$Q | ! /A | 1 1 | A A | Q Q | a +A | q +Q |
| STX \$B | DC2 \$R | " /B | 2 2 | B B | R R | b +B | r +R |
| ETX \$C | DC3 \$S | # /C | 3 3 | C C | S S | c +C | s +S |
| EOT \$D | DC4 \$T | \$ /D | 4 4 | D D | T T | d +D | t +T |
| ENQ \$E | NAK \$U | % /E | 5 5 | E E | U U | e +E | u +U |
| ACK \$F | SYN \$V | & /F | 6 6 | F F | V V | f +F | v +V |
| BEL \$G | ETB \$W | ' /G | 7 7 | G G | W W | g +G | w +W |
| BS \$H | CAN \$X | (/H | 8 8 | H H | X X | h +H | x +X |
| HT \$I | EM \$Y |) /I | 9 9 | I I | Y Y | i +I | y +Y |
| LF \$J | SUB \$Z | * /J | : /Z | J J | Z Z | j +J | z +Z |
| VT \$K | ESC %A | + /K | ; %F | K K | [%K | k +K | { %P |
| FF \$L | FS %B | , /L | < %G | L L | \ %L | l +L | %Q |
| CR \$M | GS %C | - - | = %H | M M |] %M | m +M | } %R |
| SO \$N | RS %D | . . | > %I | N N | ^ %N | n +N | ~ %S |
| SI \$O | US %E | / /O | ? %J | O O | _ %O | o +O | DEL %T |

Character pairs /M and /N decode as a minus sign and period respectively.

Character pairs /P through /Y decode as 0 through 9.



C39ASC1.
Full ASCII On



C39ASC0.
* Full ASCII Off

Code 39 Code Page

Code pages define the mapping of character codes to characters. If the data received does not display with the proper characters, it may be because the bar code being scanned was created using a code page that is different from the one the host program is expecting. If this is the case, scan the bar code below, select the code page with which the bar codes were created (see [ISO 2022/ISO 646 Character Replacements](#) on page A-7), and scan the value and the **Save** bar code from the [Programming Chart](#) on the inside the back cover of this manual. The data characters should then appear properly.



C39DCP.
Code 39 Code Page

Interleaved 2 of 5

< Default All Interleaved 2 of 5 Settings >



Interleaved 2 of 5 On/Off



Check Digit

No Check Digit indicates that the scanner reads and transmits bar code data with or without a check digit.

When Check Digit is set to **Validate, but Don't Transmit**, the unit only reads Interleaved 2 of 5 bar codes printed with a check digit, but will not transmit the check digit with the scanned data.

When Check Digit is set to **Validate and Transmit**, the scanner only reads Interleaved 2 of 5 bar codes printed with a check digit, and will transmit this digit at the end of the scanned data. *Default = No Check Digit.*



Interleaved 2 of 5 Message Length

Scan the bar codes below to change the message length. Refer to [Message Length Description](#) (page 7-1) for additional information. Minimum and Maximum lengths = 2-80. Minimum Default = 4, Maximum Default = 80.





NEC 2 of 5

< Default All NEC 2 of 5 Settings >



NEC 2 of 5 On/Off



Check Digit

No Check Digit indicates that the scanner reads and transmits bar code data with or without a check digit.

When Check Digit is set to **Validate, but Don't Transmit**, the unit only reads NEC 2 of 5 bar codes printed with a check digit, but will not transmit the check digit with the scanned data.

When Check Digit is set to **Validate and Transmit**, the scanner only reads NEC 2 of 5 bar codes printed with a check digit, and will transmit this digit at the end of the scanned data. *Default = No Check Digit.*



NEC 2 of 5 Message Length

Scan the bar codes below to change the message length. Refer to [Message Length Description](#) (page 7-1) for additional information. Minimum and Maximum lengths = 2-80. Minimum Default = 4, Maximum Default = 80.



N25MIN.

Minimum Message Length



N25MAX.

Maximum Message Length

Code 93

< Default All Code 93 Settings >



C93DFT.

Code 93 On/Off



C93ENA1.

* On



C93ENA0.

Off

Code 93 Message Length

Scan the bar codes below to change the message length. Refer to [Message Length Description](#) (page 7-1) for additional information. Minimum and Maximum lengths = 0-80. Minimum Default = 0, Maximum Default = 80.



C93MIN.

Minimum Message Length



C93MAX.

Maximum Message Length

Code 93 Append

This function allows the scanner to append the data from several Code 93 bar codes together before transmitting them to the host computer. When this function is enabled, the scanner stores those Code 93 bar codes that start with a space (excluding the start and stop symbols), and does not immediately transmit the data. The scanner stores the data in the order in which the bar codes are read, deleting the first space from each. The scanner transmits the appended data when it reads a Code 93 bar code that starts with a character other than a space. *Default = Off.*



C93APP1.

On



C93APP0.

* Off

Code 93 Code Page

Code pages define the mapping of character codes to characters. If the data received does not display with the proper characters, it may be because the bar code being scanned was created using a code page that is different from the one the host program is expecting. If this is the case, scan the bar code below, select the code page with which the bar codes were created (see [ISO 2022/ISO 646 Character Replacements](#) on page A-7), and scan the value and the **Save** bar code from the [Programming Chart](#) on the inside the back cover of this manual. The data characters should then appear properly.



C93DCP.

Code 93 Code Page

Straight 2 of 5 Industrial (three-bar start/stop)

<Default All Straight 2 of 5 Industrial Settings>



R25DFT.

Straight 2 of 5 Industrial On/Off



R25ENA1.

On



R25ENA0.

*** Off**

Straight 2 of 5 Industrial Message Length

Scan the bar codes below to change the message length. Refer to [Message Length Description](#) (page 7-1) for additional information. Minimum and Maximum lengths = 1-48. Minimum Default = 4, Maximum Default = 48.



R25MIN.

Minimum Message Length



R25MAX.

Maximum Message Length

Straight 2 of 5 IATA (two-bar start/stop)

<Default All Straight 2 of 5 IATA Settings>



A25DFT.

Straight 2 of 5 IATA On/Off



A25ENA1.

On



A25ENA0.

* Off

Straight 2 of 5 IATA Message Length

Scan the bar codes below to change the message length. Refer to [Message Length Description](#) (page 7-1) for additional information. Minimum and Maximum lengths = 1-48. Minimum Default = 4, Maximum Default = 48.



A25MIN.

Minimum Message Length



A25MAX.

Maximum Message Length

Matrix 2 of 5

<Default All Matrix 2 of 5 Settings>



X25DFT.

Matrix 2 of 5 On/Off



X25ENA1.

On



X25ENA0.

* Off

Matrix 2 of 5 Message Length

Scan the bar codes below to change the message length. Refer to [Message Length Description](#) (page 7-1) for additional information. Minimum and Maximum lengths = 1-80. Minimum Default = 4, Maximum Default = 80.



X25MIN.

Minimum Message Length



X25MAX.

Maximum Message Length

Code 11

<Default All Code 11 Settings>



Code 11 On/Off



Check Digits Required

This option sets whether 1 or 2 check digits are required with Code 11 bar codes. *Default = Two Check Digits.*



Code 11 Message Length

Scan the bar codes below to change the message length. Refer to [Message Length Description](#) (page 7-1) for additional information. Minimum and Maximum lengths = 1-80. Minimum Default = 4, Maximum Default = 80.



Code 128

<Default All Code 128 Settings>



Code 128 On/Off



ISBT 128 Concatenation

In 1994 the International Society of Blood Transfusion (ISBT) ratified a standard for communicating critical blood information in a uniform manner. The use of ISBT formats requires a paid license. The ISBT 128 Application Specification describes 1) the critical data elements for labeling blood products, 2) the current recommendation to use Code 128 due to its high degree of security and its space-efficient design, 3) a variation of Code 128 that supports concatenation of neighboring symbols, and 4) the standard layout for bar codes on a blood product label. Use the bar codes below to turn concatenation on or off. *Default =Off.*



Code 128 Message Length

Scan the bar codes below to change the message length. Refer to [Message Length Description](#) (page 7-1) for additional information. Minimum and Maximum lengths = 0-80. Minimum Default = 0, Maximum Default = 80.



Code 128 Append

This function allows the scanner to append the data from several Code 128 bar codes together before transmitting them to the host computer. When the scanner encounters a Code 128 bar code with the append trigger character(s), it buffers Code 128 bar codes until it reads a Code 128 bar code that does not have the append trigger. The data is then transmitted in the order in which the bar codes were read (FIFO). *Default = On.*



128APP1.

* On



128APP0.

Off

Code 128 Code Page

Code pages define the mapping of character codes to characters. If the data received does not display with the proper characters, it may be because the bar code being scanned was created using a code page that is different from the one the host program is expecting. If this is the case, scan the bar code below, select the code page with which the bar codes were created (see [ISO 2022/ISO 646 Character Replacements](#) on page A-7), and scan the value and the **Save** bar code from the [Programming Chart](#) on the inside the back cover of this manual. The data characters should then appear properly.



128DCP.

Code 128 Code Page

GS1-128

<Default All GS1-128 Settings>



GS1-128 On/Off



GS1-128 Message Length

Scan the bar codes below to change the message length. Refer to [Message Length Description](#) (page 7-1) for additional information. Minimum and Maximum lengths = 1-80. Minimum Default = 1, Maximum Default = 80.



Telepen

<Default All Telepen Settings>



Telepen On/Off



Telepen Output

Using AIM Telepen Output, the scanner reads symbols with start/stop pattern 1 and decodes them as standard full ASCII (start/stop pattern 1). When Original Telepen Output is selected, the scanner reads symbols with start/stop pattern 1 and decodes them as compressed numeric with optional full ASCII (start/stop pattern 2). *Default = AIM Telepen Output.*



Telepen Message Length

Scan the bar codes below to change the message length. Refer to [Message Length Description](#) (page 7-1) for additional information. Minimum and Maximum lengths = 1-60. Minimum Default = 1, Maximum Default = 60.



UPC-A

<Default All UPC-A Settings>



UPC-A On/Off



Note: To convert UPC-A bar codes to EAN-13, see [Convert UPC-A to EAN-13](#) on page 7-24.

UPC-A Check Digit

This selection allows you to specify whether the check digit should be transmitted at the end of the scanned data or not.
Default = On.



UPC-A Number System

The numeric system digit of a U.P.C. symbol is normally transmitted at the beginning of the scanned data, but the unit can be programmed so it will not transmit it. Default = On.



UPC-A Addenda

This selection adds 2 or 5 digits to the end of all scanned UPC-A data.

Default = Off for both 2 Digit and 5 Digit Addenda.



UPAAD21.
2 Digit Addenda On



UPAAD51.
5 Digit Addenda On



UPAAD20.
* 2 Digit Addenda Off



UPAAD50.
* 5 Digit Addenda Off

UPC-A Addenda Required

When **Required** is scanned, the scanner will only read UPC-A bar codes that have addenda. You must then turn on a 2 or 5 digit addenda listed on [page 7-20](#). *Default = Not Required.*



UPAARQ1.
Required



UPAARQ0.
* Not Required

UPC-A Addenda Separator

When this feature is on, there is a space between the data from the bar code and the data from the addenda. When turned off, there is no space. *Default = On.*



UPAADS1.
* On



UPAADS0.
Off

UPC-A/EAN-13 with Extended Coupon Code

Use the following codes to enable or disable UPC-A and EAN-13 with Extended Coupon Code. When left on the default setting (**Off**), the scanner treats Coupon Codes and Extended Coupon Codes as single bar codes.

If you scan the **Allow Concatenation** code, when the scanner sees the coupon code and the extended coupon code in a single scan, it transmits both as separate symbologies. Otherwise, it transmits the first coupon code it reads.

If you scan the **Require Concatenation** code, the scanner must see and read the coupon code and extended coupon code in a single read to transmit the data. No data is output unless both codes are read. *Default = Off.*



CPNENA0.

* Off



CPNENA1.

Allow Concatenation



CPNENA2.

Require Concatenation

Coupon GS1 DataBar Output

If you scan coupons that have both UPC and GS1 DataBar codes, you may wish to scan and output only the data from the GS1 DataBar code. Scan the **GS1 Output On** code below to scan and output only the GS1 DataBar code data. *Default = GS1 Output Off.*



CPNGS10.

* GS1 Output Off



CPNGS11.

GS1 Output On

UPC-E0

<Default All UPC-E Settings>



UPC-E0 On/Off

Most U.P.C. bar codes lead with the 0 number system. To read these codes, use the **UPC-E0 On** selection. If you need to read codes that lead with the 1 number system, use [UPC-E1](#) (page 7-24). *Default = On.*



UPC-E0 Expand

UPC-E Expand expands the UPC-E code to the 12 digit, UPC-A format. *Default = Off.*



UPC-E0 Addenda Required

When **Required** is scanned, the scanner will only read UPC-E bar codes that have addenda. *Default = Not Required.*



UPC-E0 Addenda Separator

When this feature is **On**, there is a space between the data from the bar code and the data from the addenda. When turned **Off**, there is no space. *Default = On.*



UPC-E0 Check Digit

Check Digit specifies whether the check digit should be transmitted at the end of the scanned data or not. *Default = On.*



UPC-E0 Leading Zero

This feature allows the transmission of a leading zero (0) at the beginning of scanned data. To prevent transmission, scan **Off**. *Default = On.*



UPC-E0 Addenda

This selection adds 2 or 5 digits to the end of all scanned UPC-E data. *Default = Off for both 2 Digit and 5 Digit Addenda.*





UPEAD51.
5 Digit Addenda On



UPEAD50.
* 5 Digit Addenda Off

UPC-E1

Most U.P.C. bar codes lead with the 0 number system. For these codes, use [UPC-E0](#) (page 7-22). If you need to read codes that lead with the 1 number system, use the **UPC-E1 On** selection. *Default = Off.*



UPEEN11.
UPC-E1 On



UPEEN10.
* UPC-E1 Off

EAN/JAN-13

<Default All EAN/JAN Settings>



E13DFT.

EAN/JAN-13 On/Off



E13ENA1.
* On



E13ENA0.
Off

Convert UPC-A to EAN-13

When **UPC-A Converted to EAN-13** is selected, UPC-A bar codes are converted to 13 digit EAN-13 codes by adding a zero to the front. When **Do not Convert UPC-A** is selected, UPC-A codes are read as UPC-A.



UPAENA0.
UPC-A Converted to EAN-13



UPAENA1.

* Do not Convert UPC-A

EAN/JAN-13 Check Digit

This selection allows you to specify whether the check digit should be transmitted at the end of the scanned data or not.

Default = On.



E13CKX1.

* On



E13CKX0.

Off

EAN/JAN-13 Addenda

This selection adds 2 or 5 digits to the end of all scanned EAN/JAN-13 data. *Default = Off for both 2 Digit and 5 Digit Addenda.*



E13AD21.

2 Digit Addenda On



E13AD20.

* 2 Digit Addenda Off



E13AD51.

5 Digit Addenda On



E13AD50.

* 5 Digit Addenda Off

EAN/JAN-13 Addenda Required

When **Required** is scanned, the scanner will only read EAN/JAN-13 bar codes that have addenda. *Default = Not Required.*



E13ARQ1.

Required



E13ARQ0.

* Not Required

EAN/JAN-13 Addenda Separator

When this feature is **On**, there is a space between the data from the bar code and the data from the addenda. When turned **Off**, there is no space. *Default = On.*



E13ADS1.

* On



E13ADS0.

Off

Note: If you want to enable or disable EAN13 with Extended Coupon Code, refer to [UPC-A/EAN-13 with Extended Coupon Code](#) (page 7-21).

ISBN Translate

When **On** is scanned, EAN-13 Bookland symbols are translated into their equivalent ISBN number format. *Default = Off.*



E13ISB1.

On



E13ISB0.

* Off

EAN/JAN-8

<Default All EAN/JAN-8 Settings>



EAN/JAN-8 On/Off



EAN/JAN-8 Check Digit

This selection allows you to specify whether the check digit should be transmitted at the end of the scanned data or not.
Default = On.



EAN/JAN-8 Addenda

This selection adds 2 or 5 digits to the end of all scanned EAN/JAN-8 data. *Default = Off for both 2 Digit and 5 Digit Addenda.*





EAN/JAN-8 Addenda Required

When **Required** is scanned, the scanner will only read EAN/JAN-8 bar codes that have addenda. *Default = Not Required.*



EAN/JAN-8 Addenda Separator

When this feature is **On**, there is a space between the data from the bar code and the data from the addenda. When turned **Off**, there is no space. *Default = On.*



MSI

<Default All MSI Settings>



MSI On/Off



MSI Check Character

Different types of check characters are used with MSI bar codes. You can program the scanner to read MSI bar codes with Type 10 check characters. *Default = Validate Type 10, but Don't Transmit.*

When Check Character is set to **Validate Type 10/11 and Transmit**, the scanner will only read MSI bar codes printed with the specified type check character(s), and will transmit the character(s) at the end of the scanned data.

When Check Character is set to **Validate Type 10/11, but Don't Transmit**, the unit will only read MSI bar codes printed with the specified type check character(s), but will not transmit the check character(s) with the scanned data.



* **Validate Type 10, but Don't Transmit**



Validate Type 10 and Transmit



Validate 2 Type 10 Characters, but Don't Transmit



Validate 2 Type 10 Characters and Transmit



Validate Type 11 then Type 10 Character, but Don't Transmit



MSCHK5.
Validate Type 11 then
Type 10 Character and Transmit



MSCHK6.
Disable MSI Check Characters

MSI Message Length

Scan the bar codes below to change the message length. Refer to [Message Length Description](#) (page 7-1) for additional information. Minimum and Maximum lengths = 4-48. Minimum Default = 4, Maximum Default = 48.



MSIMIN.
Minimum Message Length



MSIMAX.
Maximum Message Length

GS1 DataBar Omnidirectional

< Default All GS1 DataBar Omnidirectional Settings >



GS1 DataBar Omnidirectional On/Off



GS1 DataBar Limited

< Default All GS1 DataBar Limited Settings >



GS1 DataBar Limited On/Off



GS1 DataBar Expanded

< Default All GS1 DataBar Expanded Settings >



GS1 DataBar Expanded On/Off



GS1 DataBar Expanded Message Length

Scan the bar codes below to change the message length. Refer to [Message Length Description](#) (page 7-1) for additional information. Minimum and Maximum lengths = 4-74. Minimum Default = 4, Maximum Default = 74.



Trioptic Code

Note: If you are going to scan Code 32 Pharmaceutical codes ([page 7-5](#)), Trioptic Code must be off.

Trioptic Code is used for labeling magnetic storage media.



Codablock A

<Default All Codablock A Settings>



Codablock A On/Off



Codablock A Message Length

Scan the bar codes below to change the message length. Refer to [Message Length Description](#) (page 7-1) for additional information. Minimum and Maximum lengths = 1-600. Minimum Default = 1, Maximum Default = 600.



Minimum Message Length



Maximum Message Length

Codablock F

<Default All Codablock F Settings>



Codablock F On/Off



Codablock F Message Length

Scan the bar codes below to change the message length. Refer to [Message Length Description](#) (page 7-1) for additional information. Minimum and Maximum lengths = 1-2048. Minimum Default = 1, Maximum Default = 2048.



PDF417

< Default All PDF417 Settings >



PDF417 On/Off



PDF417 Message Length

Scan the bar codes below to change the message length. Refer to [Message Length Description](#) (page 7-1) for additional information. Minimum and Maximum lengths = 1-2750. Minimum Default = 1, Maximum Default = 2750.



MacroPDF417

MacroPDF417 is an implementation of PDF417 capable of encoding very large amounts of data into multiple PDF417 bar codes. When this selection is enabled, these multiple bar codes are assembled into a single data string. *Default = On.*



MicroPDF417

< Default All MicroPDF417 Settings >



MicroPDF417 On/Off



MicroPDF417 Message Length

Scan the bar codes below to change the message length. Refer to [Message Length Description](#) (page 7-1) for additional information. Minimum and Maximum lengths = 1-366. Minimum Default = 1, Maximum Default = 366.



GS1 Composite Codes

Linear codes are combined with a unique 2D composite component to form a new class called GS1 Composite symbology. GS1 Composite symbologies allow for the co-existence of symbologies already in use. *Default = Off.*



UPC/EAN Version

Scan the **UPC/EAN Version On** bar code to decode GS1 Composite symbols that have a U.P.C. or an EAN linear component. (This does not affect GS1 Composite symbols with a GS1-128 or GS1 linear component.) *Default = UPC/EAN Version Off.*



Note: If you scan coupons that have both UPC and GS1 DataBar codes, you may wish to scan and output only the data from the GS1 DataBar code. See [Coupon GS1 DataBar Output](#) (page 7-21) for further information.

GS1 Composite Code Message Length

Scan the bar codes below to change the message length. Refer to [Message Length Description](#) (page 7-1) for additional information. Minimum and Maximum lengths = 1-2435. Minimum Default = 1, Maximum Default = 2435.



GS1 Emulation

The scanner can automatically format the output from any GS1 data carrier to emulate what would be encoded in an equivalent GS1-128 or GS1 DataBar symbol. GS1 data carriers include UPC-A and UPC-E, EAN-13 and EAN-8, ITF-14, GS1-128, and GS1-128 DataBar and GS1 Composites. (Any application that accepts GS1 data can be simplified since it only needs to recognize one data carrier type.)

If **GS1-128 Emulation** is scanned, all retail codes (U.P.C., UPC-E, EAN8, EAN13) are expanded out to 16 digits. If the AIM ID is enabled, the value will be the GS1-128 AIM ID,]C1 (see [Symbology Charts](#) on page A-1).

If **GS1 DataBar Emulation** is scanned, all retail codes (U.P.C., UPC-E, EAN8, EAN13) are expanded out to 16 digits. If the AIM ID is enabled, the value will be the GS1-DataBar AIM ID,]em (see [Symbology Charts](#) on page A-1).

If **GS1 Code Expansion Off** is scanned, retail code expansion is disabled, and UPC-E expansion is controlled by the [UPC-E0 Expand](#) (page 7-22) setting. If the AIM ID is enabled, the value will be the GS1-128 AIM ID,]C1 (see [Symbology Charts](#) on page A-1).

If **EAN8 to EAN13 Conversion** is scanned, all EAN8 bar codes are converted to EAN13 format.

Default = GS1 Emulation Off.





TCIF Linked Code 39 (TLC39)

This code is a composite code since it has a Code 39 linear component and a MicroPDF417 stacked code component. All bar code readers are capable of reading the Code 39 linear component. The MicroPDF417 component can only be decoded if **TLC39 On** is selected. The linear component may be decoded as Code 39 even if TLC39 is off. *Default = Off.*



QR Code

< *Default All QR Code Settings* >



QR Code On/Off

This selection applies to both QR Code and Micro QR Code.



QR Code Message Length

Scan the bar codes below to change the message length. Refer to [Message Length Description](#) (page 7-1) for additional information. Minimum and Maximum lengths = 1-7089. Minimum Default = 1, Maximum Default = 7089.



QRCMIN.

Minimum Message Length



QRCMAX.

Maximum Message Length

QR Code Append

This function allows the scanner to append the data from several QR Code bar codes together before transmitting them to the host computer. When the scanner encounters an QR Code bar code with the append trigger character(s), it buffers the number of QR Code bar codes determined by information encoded in those bar codes. Once the proper number of codes is reached, the data is output in the order specified in the bar codes. *Default = On.*



QRCAPP1.

* On



QRCAPP0.

Off

QR Code Page

QR Code pages define the mapping of character codes to characters. If the data received does not display with the proper characters, it may be because the bar code being scanned was created using a code page that is different from the one the host program is expecting. If this is the case, scan the bar code below, select the code page with which the bar codes were created (see [ISO 2022/ISO 646 Character Replacements](#) on page A-7), and scan the value and the **Save** bar code from the [Programming Chart](#) on the inside the back cover of this manual. The data characters should then appear properly.



QRCDP.

QR Code Page

Data Matrix

< Default All Data Matrix Settings >



Data Matrix On/Off



Data Matrix Message Length

Scan the bar codes below to change the message length. Refer to [Message Length Description](#) (page 7-1) for additional information. Minimum and Maximum lengths = 1-3116. Minimum Default = 1, Maximum Default = 3116.



Data Matrix Append

This function allows the scanner to append the data from several Data Matrix bar codes together before transmitting them to the host computer. When the scanner encounters a Data Matrix bar code with the append trigger character(s), it buffers the number of Data Matrix bar codes determined by information encoded in those bar codes. Once the proper number of codes is reached, the data is output in the order specified in the bar codes. *Default = On.*



Data Matrix Code Page

Data Matrix Code pages define the mapping of character codes to characters. If the data received does not display with the proper characters, it may be because the bar code being scanned was created using a code page that is different from the one the host program is expecting. If this is the case, scan the bar code below, select the code page with which the bar

codes were created (see [ISO 2022/ISO 646 Character Replacements](#) on page A-7), and scan the value and the **Save** bar code from the [Programming Chart](#) on the inside the back cover of this manual. The data characters should then appear properly.



MaxiCode

< Default All MaxiCode Settings >



MaxiCode On/Off



MaxiCode Message Length

Scan the bar codes below to change the message length. Refer to [Message Length Description](#) (page 7-1) for additional information. Minimum and Maximum lengths = 1-150. Minimum Default = 1, Maximum Default = 150.



Aztec Code

< Default All Aztec Code Settings >



Aztec Code On/Off



Aztec Code Message Length

Scan the bar codes below to change the message length. Refer to [Message Length Description](#) (page 7-1) for additional information. Minimum and Maximum lengths = 1-3832. Minimum Default = 1, Maximum Default = 3832.



Aztec Append

This function allows the scanner to append the data from several Aztec bar codes together before transmitting them to the host computer. When the scanner encounters an Aztec bar code with the append trigger character(s), it buffers the number of Aztec bar codes determined by information encoded in those bar codes. Once the proper number of codes is reached, the data is output in the order specified in the bar codes. *Default = On.*



Aztec Code Page

Aztec Code pages define the mapping of character codes to characters. If the data received does not display with the proper characters, it may be because the bar code being scanned was created using a code page that is different from the one the host program is expecting. If this is the case, scan the bar code below, select the code page with which the bar

codes were created (see [ISO 2022/ISO 646 Character Replacements](#) on page A-7), and scan the value and the **Save** bar code from the [Programming Chart](#) on the inside the back cover of this manual. The data characters should then appear properly.



Chinese Sensible (Han Xin) Code

< Default All Han Xin Settings >



Han Xin Code On/Off



Han Xin Code Message Length

Scan the bar codes below to change the message length. Refer to [Message Length Description](#) (page 7-1) for additional information. Minimum and Maximum lengths = 1-7833. Minimum Default = 1, Maximum Default = 7833.



Postal Codes - 2D

The following lists the possible 2D postal codes, and 2D postal code combinations that are allowed. Only one 2D postal code selection can be active at a time. If you scan a second 2D postal code selection, the first selection is overwritten. *Default = 2D Postal Codes Off.*



POSTAL0.

* 2D Postal Codes Off

Single 2D Postal Codes:



POSTAL1.

Australian Post On



POSTAL7.

British Post On



POSTAL30.

Canadian Post On



POSTAL10.

Intelligent Mail Bar Code On



POSTAL3.

Japanese Post On



POSTAL4.

KIX Post On



POSTAL5.

Planet Code On

Also see [Planet Code Check Digit](#), page 7-47.



POSTAL9.

Postal-4i On



POSTAL6.
Postnet On

Also see [Postnet Check Digit](#), page 7-47.



POSTAL11.
Postnet with B and B' Fields On



POSTAL2.
InfoMail On

Combination 2D Postal Codes:



POSTAL8.
InfoMail and British
Post On



POSTAL20.
Intelligent Mail Bar Code and
Postnet with B and B' Fields On



POSTAL14.
Postnet and
Postal-4i On



POSTAL16.
Postnet and
Intelligent Mail Bar Code On



POSTAL17.
Postal-4i and
Intelligent Mail Bar Code On



POSTAL19.
Postal-4i and
Postnet with B and B' Fields On



POSTAL12.
Planet Code and
Postnet On



POSTAL13.
Planet Code and
Postal-4i On



POSTAL21.
Planet Code,
Postnet, and
Postal-4i On



POSTAL23.
Planet Code,
Postal-4i, and
Intelligent Mail Bar Code On



POSTAL25.
Planet Code,
Postal-4i, and
Postnet with B and B' Fields On



POSTAL27.
Postal-4i,
Intelligent Mail Bar Code, and
Postnet with B and B' Fields On



POSTAL18.
Planet Code and
Postnet with B and B' Fields On



POSTAL15.
Planet Code and
Intelligent Mail Bar Code On



POSTAL22.
Planet Code,
Postnet, and
Intelligent Mail Bar Code On



POSTAL24.
Postnet,
Postal-4i, and
Intelligent Mail Bar Code On



POSTAL26.
Planet Code,
Intelligent Mail Bar Code, and
Postnet with B and B' Fields On



POSTAL28.
Planet Code,
Postal-4i,
Intelligent Mail Bar Code, and
Postnet On



POSTAL29.
Planet Code,
Postal-4i,
Intelligent Mail Bar Code, and
Postnet with B and B' Fields On

Planet Code Check Digit

This selection allows you to specify whether the check digit should be transmitted at the end of Planet Code data. *Default = Don't Transmit.*



PLNCKX1.
Transmit Check Digit



PLNCKXD.
* Don't Transmit Check Digit

Postnet Check Digit

This selection allows you to specify whether the check digit should be transmitted at the end of Postnet data. *Default = Don't Transmit.*



NETCKX1.
Transmit Check Digit



NETCKXD.
* Don't Transmit Check Digit

Australian Post Interpretation

This option controls what interpretation is applied to customer fields in Australian 4-State symbols.

Bar Output lists the bar patterns in "0123" format.

Numeric N Table causes that field to be interpreted as numeric data using the N Table.

Alphanumeric C Table causes the field to be interpreted as alphanumeric data using the C Table. Refer to the Australian Post Specification Tables.

Combination C and N Tables causes the field to be interpreted using either the C or N Tables.



AUSINT0.

* Bar Output



AUSINT1.

Numeric N Table



AUSINT2.

Alphanumeric C Table



AUSINT3.

Combination C and N Tables

Postal Codes - Linear

The following lists linear postal codes. Any combination of linear postal code selections can be active at a time.

China Post (Hong Kong 2 of 5)

<Default All China Post (Hong Kong 2 of 5) Settings>



CPCDFT.

China Post (Hong Kong 2 of 5) On/Off



CPCENA1.

On



CPCENAD.

* Off

China Post (Hong Kong 2 of 5) Message Length

Scan the bar codes below to change the message length. Refer to [Message Length Description](#) (page 7-1) for additional information. Minimum and Maximum lengths = 2-80. Minimum Default = 4, Maximum Default = 80.



CPCMIN.

Minimum Message Length



Korea Post

<Default All Korea Post Settings>



Korea Post



Korea Post Message Length

Scan the bar codes below to change the message length. Refer to [Message Length Description](#) (page 7-1) for additional information. Minimum and Maximum lengths = 2-80. Minimum Default = 4, Maximum Default = 48.



Korea Post Check Digit

This selection allows you to specify whether the check digit should be transmitted at the end of the scanned data.
Default = Don't Transmit.





Imaging Commands

The scanner is like a digital camera in the way it captures, manipulates, and transfers images. The following commands allow you to alter the way the scanner performs these functions.

Note: If you are using the scanner in a stand, you must set the In-Stand Sensor Mode to Off in order to take images (see [In-Stand Sensor Mode](#) on page 4-10).

Single-Use Basis

Imaging Commands with their modifiers send instructions to the scanner on a single-use basis, and take effect for a single image capture. Once that capture is complete, the scanner reverts to its imaging default settings. If you want to permanently change a setting, you must use the serial default commands (see [Chapter 11](#)). When the serial default command is used, that selection becomes the new, permanent setting for the scanner.

Command Syntax

Multiple modifiers and commands can be issued within one sequence. If additional modifiers are to be applied to the same command, just add the modifiers to that command. For example, to add 2 modifiers to the Image Snap command, such as setting the Imaging Style to 1P and the Wait for Trigger to 1T, you would enter **IMG SNP1P1T**.

Note: After processing an image capture command (IMG SNP or IMG BOX), you must follow it with an IMG SHP command if you want to see it on your terminal.

To add a command to a sequence, each new command is separated with a semicolon. For example, to add the Image Ship command to the above sequence, you would enter **IMG SNP1P1T;IMG SHP**.

The imaging commands are:

[Image Snap - IMG SNP](#) (page 8-1)

[Image Ship - IMG SHP](#) (page 8-3)

[Intelligent Signature Capture - IMG BOX](#) (page 8-10)

The modifiers for each of these commands follow the command description.

Note: The images included with each command description are examples only. The results you achieve may be different from those included in this manual. The quality of the output you receive will vary depending on lighting, quality of the initial image/object being captured, and distance of the scanner from the image/object. To achieve a high quality image, it is recommended that you position your scanner 4-6" (10.2-15.2 cm) away from the image/object you are capturing.

Step 1 - Take a Picture Using IMG SNP

Image Snap - IMG SNP

An image is taken whenever the hardware button is pressed, or when the Image Snap (IMG SNP) command is processed.

The image snap command has many different modifiers that can be used to change the look of the image in memory. Any number of modifiers may be appended to the IMG SNP command. For example, you can use the following command to snap an image, increase the gain, and have the beeper sound once the snap is complete: **IMG SNP2G1B**

IMG SNP Modifiers

P - Imaging Style

This sets the Image Snap style.

0P **Decoding Style.** This processing allows a few frames to be taken until the exposure parameters are met. The last frame is then available for further use.

1P **Photo Style (default).** This mimics a simple digital camera, and results in a visually optimized image.

2P **Manual Style.** This is an advanced style that should only be used by an experienced user. It allows you the most freedom to set up the scanner, and has no auto-exposure.

B - Beeper

Causes a beep to sound after an image is snapped.

0B No beep (*default*)

1B Sounds a beep when the image is captured.

T - Wait for Trigger

Waits for a hardware button push before taking the image. This is only available when using Photo Style (1P).

0T Takes image immediately (*default*)

1T Waits for a button push, then takes the image

L - LED State

Determines if the LEDs should be on or off, and when. Ambient illumination (0L) is preferred for taking pictures of color documents, such as ID cards, especially when the scanner is in a stand. LED illumination (1L) is preferred when the scanner is handheld. LED State is not available when using Decoding Style (0P).

0L LEDs off (*default*)

1L LEDs on

E - Exposure

Exposure is used in Manual Style only (2P), and allows you to set the exposure time. This is similar to setting a shutter speed on a camera. The exposure time determines how long the scanner takes to record an image. On a bright day, exposure times can be very short because plenty of light is available to help record an image. At nighttime, exposure time can increase dramatically due to the near absence of light. Units are 127 microseconds. (*Default = 7874*)

nE Range: 1 - 7874

Example of Exposure at 7874E with fluorescent lighting:

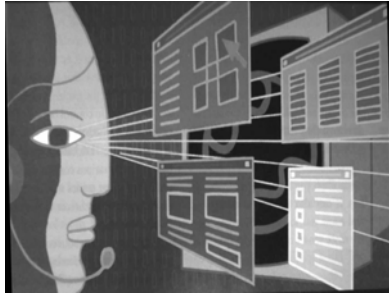

Example of Exposure at 100E with fluorescent lighting:



G - Gain

Gain is used in Manual Style only (2P). Like a volume control, the gain modifier boosts the signal and multiplies the pixel value. As you increase the gain, the noise in an image is also amplified.

1G No gain (*default*)

2G Medium gain

4G Heavy gain

8G Maximum gain

Example of Gain at 1G:



Example of Gain at 4G:

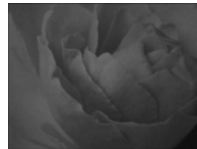

Example of Gain at 8G:



W - Target White Value

Sets the target for the median grayscale value in the captured image. For capturing close-up images of high contrast documents, a lower setting, such as 75, is recommended. Higher settings result in longer exposure times and brighter images, but if the setting is too high, the image may be overexposed. Target White Value is only available when using Photo Style (1P). (Default = 125)

nW Range: 0 - 255

Example of White Value at 75W:



Example of White Value at 125W:



Example of White Value at 200W:



D - Delta for Acceptance

This sets the allowable range for the white value setting (see [W - Target White Value](#)). Delta is only available when using Photo Style (1P). (Default = 25)

nD Range: 0 - 255

U - Update Tries

This sets the maximum number of frames the scanner should take to reach the [D - Delta for Acceptance](#). Update Tries is only available when using Photo Style (1P). (Default = 6)

nU Range: 0 - 10

% - Target Set Point Percentage

Sets the target point for the light and dark values in the captured image. A setting of 75% means 75% of the pixels are at or below the target white value, and 25% of the pixels are above the target white value. Altering this setting from the default is not recommended under normal circumstances. To alter grayscale values, [W - Target White Value](#) should be used. (Default = 50)

n% Range: 1 - 99

Example of Target Set Point Percentage at 97%:

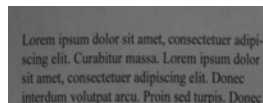

Example of Target Set Point Percentage at 50%:

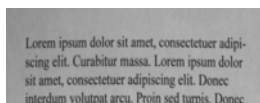

Example of Target Set Point Percentage at 40%:

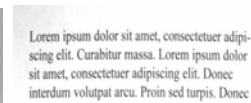

Step 2 - Ship a Picture Using IMGSHIP

Image Ship - IMGSHIP

An image is taken whenever the button is pressed, or when the Image Snap (IMGSNP) command is processed. The last image is always stored in memory. You can “ship” the image by using the IMGSHIP command.

The image ship commands have many different modifiers that can be used to change the look of the image output. Modifiers affect the image that is transmitted, but do not affect the image in memory. Any number of modifiers may be appended to the IMGSHIP command. For example, you can use the following command to snap and ship a bitmap image with gamma correction and document image filtering: **IMGSNP;IMGSHIP8F75K26U**

IMGSHP Modifiers

A - Infinity Filter

Enhances pictures taken from very long distances (greater than 10 feet or 3m). The Infinity Filter should not be used with [IMGSNP Modifiers](#) (page 8-1).

0A Infinity filter off (*default*)

1A Infinity filter on

Example of Infinity Filter off (0A)
from approximately 12 feet
(3.66m) away:

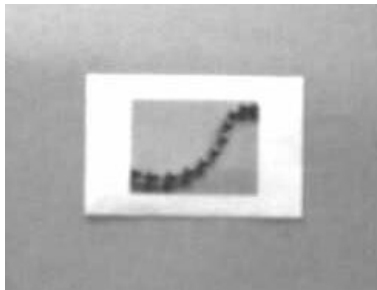

Example of Infinity Filter on (1A)
from approximately 12 feet (3.66m)
away:

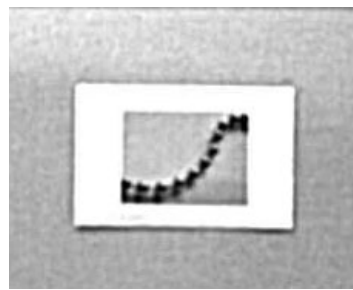

C - Compensation

Flattens the image to account for variations in illumination across the image.

0C Compensation disabled (*default*)

1C Compensation enabled

Example of Compensation at 0C:



Example of Compensation at 1C:

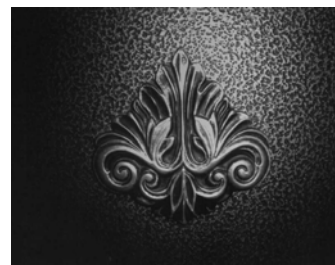

D - Pixel Depth

Indicates the number of bits per pixel in the transmitted image (KIM or BMP format only).

8D 8 bits per pixel, grayscale image (*default*)

1D 1 bit per pixel, black and white image

E - Edge Sharpen

An edge sharpen filter cleans up the edges of an image, making it look cleaner and sharper. While edge sharpening does make the image look cleaner, it also removes some fine detail from the original image. The strength of the edge sharpen filter can be entered from 1 to 24. Entering a 23E gives the sharpest edges, but also increases noise in the image.

- 0E Don't sharpen image (*default*)
- 14E Apply edge sharpen for typical image
- ne* Apply edge sharpen using strength n ($n = 1-24$)

Example of Edge Sharpen at 0E:



Example of Edge Sharpen at 24E:



F - File Format

Indicates the desired format for the image.

- 0F KIM format
- 1F TIFF binary
- 2F TIFF binary group 4, compressed
- 3F TIFF grayscale
- 4F Uncompressed binary (upper left to lower right, 1 pixel/bit, 0 padded end of line)
- 5F Uncompressed grayscale (upper left to lower right, bitmap format)
- 6F JPEG image (*default*)
- 8F BMP format (lower right to upper left, uncompressed)
- 10F TIFF color compressed image
- 11F TIFF color uncompressed image
- 12F JPEG color image
- 14F BMP color format
- 15F BMP Uncompressed raw image

H - Histogram Stretch

Increases the contrast of the transmitted image. Not available with some image formats.

- 0H No stretch (*default*)
- 1H Histogram stretch

Example of Histogram Stretch at 0H:



Example of Histogram Stretch at 1H:

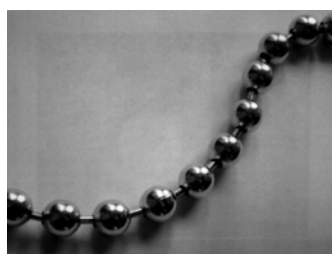

I - Invert Image

Invert image is used to rotate the image around the X or Y axis.

1ix Invert around the X axis (flips picture upside down)

1iy Invert around the Y axis (flips picture left to right)

Example of image not inverted:



Example of image with Invert Image set to 1ix:



Example of image with Invert Image set to 1iy:



IF- Noise Reduction

Used to reduce the salt and pepper noise in an image.

0if No salt and pepper noise reduction (default)

1if Salt and pepper noise reduction

Example of Noise Reduction Off (0if):

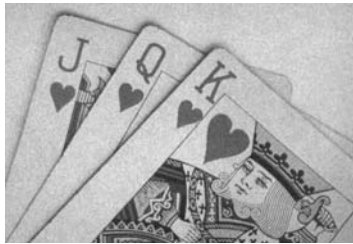

Example of Noise Reduction On (1if):



IR - Image Rotate

- 0ir Image as snapped (rightside up) (default)
- 1ir Rotate image 90 degrees to the right
- 2ir Rotate image 180 degrees (upside down)
- 3ir Rotate image 90 degrees to the left

Example of Image Rotate set to 0ir:



Example of Image Rotate set to 2ir:



Example of Image Rotate set to 1ir:



Example of Image Rotate set to 3ir:



J - JPEG Image Quality

Sets the desired quality when the JPEG image format is selected. Higher numbers result in higher quality, but larger files. Smaller numbers result in greater amounts of lossy compression, faster transmission times, lower quality, but smaller files. (Default = 50)

- nJ Image is compressed as much as possible while preserving quality factor of n ($n = 0 - 100$)
- 0J worst quality (smallest file)
- 100J best quality (largest file)

K - Gamma Correction

Gamma measures the brightness of midtone values produced by the image. You can brighten or darken an image using gamma correction. A higher gamma correction yields an overall brighter image. The lower the setting, the darker the image. The optimal setting for text images is 50K.

- 0K Gamma correction off (default)
- 50K Apply gamma correction for brightening typical document image
- nK Apply gamma correction factor n ($n = 0-1,000$)

Example of Gamma Correction set to 0K:



Example of Gamma Correction set to 50K:



Example of Gamma Correction set to 255K:



L, R, T, B, M - Image Cropping

Ships a window of the image by specifying the left, right, top, and bottom pixel coordinates. Device columns are numbered 0 through 1279, and device rows are numbered 0 through 959.

- nL* The left edge of the shipped image corresponds to column *n* of the image in memory. Range: 000 - 843. (*Default = 0*)
- nR* The right edge of the shipped image corresponds to column *n - 1* of the image in memory. Range: 000 - 843. (*Default = all columns*)
- nT* The top edge of the shipped image corresponds to row *n* of the image in memory. Range: 000 - 639. (*Default = 0*)
- nB* The bottom edge of the shipped image corresponds to row *n - 1* of the image in memory. Range: 000 - 639. (*Default = all rows*)

Uncropped Image:



Example of Image Crop set to 300R:



Example of Image Crop set to 300L:

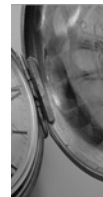

Example of Image Crop set to 200B:



Example of Image Crop set to 200T:



Alternately, specify the number of pixels to cut from the outside margin of the image; thus only the center pixels are transmitted.

- nM* Margin: cut *n* columns from the left, *n + 1* columns from the right, *n* rows from the top, and *n + 1* rows from the bottom of the image. Ship the remaining center pixels. Range: 0 - 238. (*Default = 0, or full image*)

Example of Image Crop set to 238M:



P - Protocol

Used for shipping an image. Protocol covers two features of the image data being sent to the host. It addresses the protocol used to send the data (Hmodem, which is an Xmodem 1K variant that has additional header information), and the format of the image data that is sent.

- 0P None (raw data)
- 2P None (*default for USB*)
- 3P Hmodem compressed (*default for RS232*)
- 4P Hmodem

S - Pixel Ship

Pixel Ship sizes an image in proportion to its original size. It decimates the image by shipping only certain, regularly spaced pixels. For example, **4S** would transmit every fourth pixel from every fourth line. The smaller number of pixels shipped, the smaller the image, however, after a certain point the image becomes unusable.

- 1S ship every pixel (*default*)
- 2S ship every 2nd pixel, both horizontally and vertically

3S ship every 3rd pixel, both horizontally and vertically

Example of Pixel Ship set to 1S:



Example of Pixel Ship set to 2S:



Example of Pixel Ship set to 3S:



U - Document Image Filter

Allows you to input parameters to sharpen the edges and smooth the area between the edges of text in an image. This filter should be used with gamma correction (see [page 8-7](#)), with the scanner in a stand, and the image captured using the command:

IMGSNP1P0L168W90%32D

This filter typically provides better JPEG compression than the standard E - Edge Sharpen command (see [page 8-9](#)). This filter also works well when shipping pure black and white images (1 bit per pixel). The optimal setting is 26U.

0U Document image filter off (*default*)

26U Apply document image filter for typical document image

nU Apply document image filter using grayscale threshold n. Use lower numbers when the image contrast is lower. 1U will have a similar effect to setting [E - Edge Sharpen](#) (page 8-5) to 22e. Range: 0-255.

Example of Document Image Filter set to 0U:



Example of Document Image Filter set to 26U:



V - Blur Image

Smooths transitions by averaging the pixels next to the hard edges of defined lines and shaded areas in an image.

0V Don't blur (*default*)

1V Blur

Example of Blur Image Off (0V):



Example of Blur Image On (1V):



W - Histogram Ship

A histogram gives a quick picture of the tonal range of an image, or key type. A low-key image has detail concentrated in the shadows; a high-key image has detail concentrated in the highlights; and an average-key image has detail concentrated in the midtones. This modifier ships the histogram for an image.

0W Don't ship histogram (*default*)

1W Ship histogram

Image used for histogram:

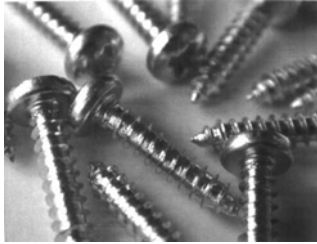

Histogram of image at left:



Image Size Compatibility

If you have applications that expect an image ship to return exactly 640x480 pixels, scan the Force VGA Resolution bar code. *Default = Native Resolution.*



IMGVGA1.

Force VGA Resolution



IMGVGA0.

*** Native Resolution**

Intelligent Signature Capture - IMGBOX

IMGBOX allows you to configure the size and location of a signature capture area relative to its proximity to a bar code. This allows you to tailor a signature capture area to a specific form. In order to use IMGBOX, you need a set form where the signature box location is in a known location relative to a bar code. You can input the overall size of the signature area, as well as specify how far the signature area is from the bar code, vertically and horizontally. You can also set the resolution and file format for the final output of the signature capture image.

Note: IMGBOX commands can only be triggered by one of the following types of bar codes: PDF417, Code 39, Code 128, Aztec, Codabar, and Interleaved 2 of 5. Once one of these symbologies has been read, the image is retained for a possible IMGBOX command.

Signature Capture Optimize

If you will be using your scanner to capture signatures frequently, you should optimize it for this purpose. However, the speed of scanning bar codes may be slowed when this mode is enabled. *Default = Off.*



DECBND1.

Optimize On



DECBND0.

*** Optimize Off**

Below is an example of a signature capture application. In this example, the aimer is centered over the signature capture area and the trigger is pressed. A single beep is emitted, indicating that the scanner has read a Code 128 bar code and the data has been transferred to the host. If using a Granit scanner, the scanner also vibrates. An IMGBOX command may now be sent from the host to specify the coordinates of the signature capture area below that code, and indicating that only that area containing the signature should be transferred as an image to the host.

To see this example, align the aimer with the signature area (not with the bar code), then press the trigger.



Send the following IMGBOX command string after the button push:

Example: IMGBOX245w37h55y.

Note: Case is not important in the command string. It is used here only for clarity.

The following image is captured:

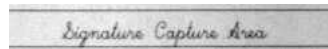

The IMGBOX commands have many different modifiers that can be used to change the size and appearance of the signature image output by the scanner. Modifiers affect the image that is transmitted, but do not affect the image in memory. Any number of modifiers may be appended to the IMGBOX command.

Note: The IMGBOX command will return a NAK unless a window size (width and height) are specified. See [H - Height of Signature Capture Area](#) (page 8-12) and [W - Width of Signature Capture Area](#) (page 8-13).

IMGBOX Modifiers

A - Output Image Width

This option is used to size the image horizontally. If using this option, set the resolution (R) to zero.

Example of Image Width set to 200A:

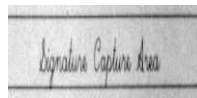

Example of Image Width set to 600A:

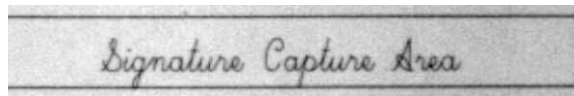

B - Output Image Height

This option is used to size the image vertically. If using this option, set the resolution (R) to zero.

Example of Image Height set to 50B:

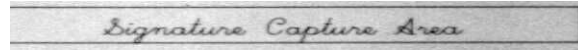

Example of Image Height set to 100B:

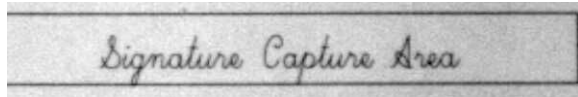

D - Pixel Depth

This indicates the number of bits per pixel in the transmitted image, which defines whether it will be grayscale or black and white.

8D 8 bits per pixel, grayscale image (*default*)

1D 1 bit per pixel, black and white image

F - File Format

This option indicates the type of file format in which to save the image.

0F KIM format

1F TIFF binary

2F TIFF binary group 4, compressed

3F TIFF grayscale

4F Uncompressed Binary

5F Uncompressed grayscale

6F JPEG image (*default*)

7F Outlined image

8F BMP format

H - Height of Signature Capture Area

The height of the signature capture area must be measured in inches divided by .01. In the example, the height of the area to be captured is 3/8 inch, resulting in a value of $H = .375/0.01 = 37.5$.

Example: *IMGBOX245w37h55y.*

K - Gamma Correction

Gamma measures the brightness of midtone values produced by the image. You can brighten or darken an image using gamma correction. A higher gamma correction yields an overall brighter image. The lower the setting, the darker the image. The optimal setting for text images is 50K.

0K Gamma correction off (*default*)

50K Apply gamma correction for brightening typical document image

nK Apply gamma correction factor *n* (*n* = 1-255)

Example of Gamma
Correction set to 0K:

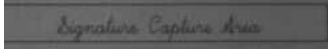

Example of Gamma Correction
set to 50K:



Example of Gamma Correction
set to 255K:

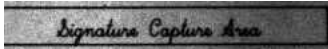

R - Resolution of Signature Capture Area

The resolution is the number of pixels that the scanner outputs per each minimum bar width. The higher the value for R, the higher the quality of the image, but also the larger the file size. Values begin at 1000. The scanner automatically inserts a decimal point between the first and second digit. For example, use 2500 to specify a resolution of 2.5. Set to zero when using the A and B modifiers (see [A - Output Image Width](#) and [B - Output Image Height](#) on page 8-12).

Example of Resolution set to 0R:

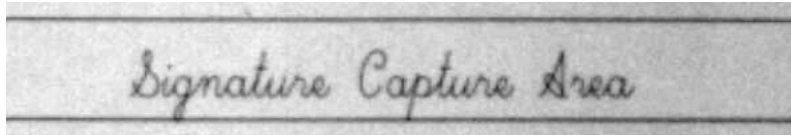

Example of Resolution set to 1000R:

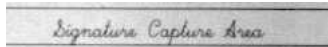

Example of Resolution set to 2000R:

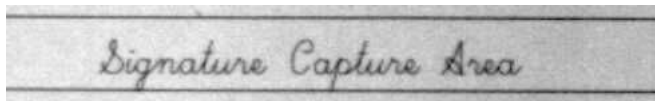

S - Bar Code Aspect Ratio

All dimensions used in IMGBOX are measured as multiples of the minimum element size of the bar code. The bar code aspect ratio allows you to set the ratio of the bar code height to the narrow element width. In the example, the narrow element width is .010 inches and the bar code height is 0.400 inches, resulting in a value of $S = 0.4/0.01 = 40$.

W - Width of Signature Capture Area

The width of the signature capture area must be measured in inches divided by .01. In the example, the width of the area to be captured is 2.4 inches, resulting in a value of $W = 2.4/0.01 = 240$. (A value of 245 was used in the example to accommodate a slightly wider image area.)

Example: *IMGBOX***245w**37h55y.

X - Horizontal Bar Code Offset

The horizontal bar code offset allows you to offset the horizontal center of the signature capture area. Positive values move the horizontal center to the right and negative values to the left. Measurements are in multiples of the minimum bar width.

Example of Horizontal Offset set to 75X:

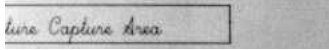

Example of Horizontal Offset set to -75X:

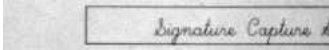

Y - Vertical Bar Code Offset

The vertical bar code offset allows you to offset the vertical center of the signature capture area. Negative numbers indicate that the signature capture is above the bar code, and positive numbers indicate that the area is below the bar code. Measurements are in multiples of the minimum bar width.

Example of Vertical Offset set to -7Y:



Example of Vertical Offset set to 65Y:

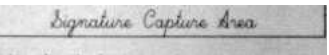

RF Default Imaging Device

The scanner supports imaging command processing (IMGSHIP, IMGSNP, IMGBOX) so that EZConfig-Scanning (see page 10-3) and other applications are able to perform imaging functions as if they were communicating directly with a scanner. To accomplish this, the scanner uses a menu command called RF_DID (RF Default Imaging Device). RF_DID is the name of the scanner (BT_NAM) that is to receive imaging commands. The default for RF_DID is "*" indicating that imaging commands are to be sent to all associated scanners. Change this setting to RF_DIDscanner_name to ensure that they are sent to a particular scanner. Refer to "Paging" on page 3-7 to generate a report containing the port, work group, scanner name, and address for each scanner. Refer to "Scanner Name" on page 3-18 set a unique name for each scanner.

Interface Keys

Keyboard Function Relationships

The following Keyboard Function Code, Hex/ASCII Value, and Full ASCII “CTRL”+ relationships apply to all terminals that can be used with the scanner. Refer to [page 2-16](#) enable Control + X (Control + ASCII) Mode.

| Function Code | HEX/ASCII Value | Full ASCII (CTRL + X Mode) |
|---------------|-----------------|----------------------------|
| NUL | 00 | @ |
| SOH | 01 | A |
| STX | 02 | B |
| ETX | 03 | C |
| EOT | 04 | D |
| ENQ | 05 | E |
| ACK | 06 | F |
| BEL | 07 | G |
| BS | 08 | H |
| HT | 09 | I |
| LF | 0A | J |
| VT | 0B | K |
| FF | 0C | L |
| CR | 0D | M |
| SO | 0E | N |
| SI | 0F | O |
| DLE | 10 | P |
| DC1 | 11 | Q |
| DC2 | 12 | R |
| DC3 | 13 | S |
| DC4 | 14 | T |
| NAK | 15 | U |
| SYN | 16 | V |
| ETB | 17 | W |
| CAN | 18 | X |
| EM | 19 | Y |
| SUB | 1A | Z |
| ESC | 1B | [|
| FS | 1C | \ |
| GS | 1D |] |
| RS | 1E | ^ |
| US | 1F | - |

The last five characters in the Full ASCII “CTRL”+ column ([\]6-), apply to US only. The following chart indicates the equivalents of these five characters for different countries.

| Country | Codes | | | | |
|----------------|-------|---|----|---|---|
| United States | [| \ |] | 6 | - |
| Belgium | [| < |] | 6 | - |
| Scandinavia | 8 | < | 9 | 6 | - |
| France | ^ | 8 | \$ | 6 | = |
| Germany | | Ã | + | 6 | - |
| Italy | | \ | + | 6 | - |
| Switzerland | | < | .. | 6 | - |
| United Kingdom | [| ç |] | 6 | - |

| Country | Codes | | | | |
|----------------|--------------|---|---|---|---|
| Denmark | 8 | \ | 9 | 6 | - |
| Norway | 8 | \ | 9 | 6 | - |
| Spain | [| \ |] | 6 | - |

Supported Interface Keys

| ASCII | HEX | IBM PC/AT and Compatibles, USB PC Keyboard | Apple Mac/iMac Supported Keys |
|-------|-----|---|----------------------------------|
| NUL | 00 | Reserved | Reserved |
| SOH | 01 | Enter (KP) | Enter/Numpad Enter |
| STX | 02 | Cap Lock | CAPS |
| ETX | 03 | ALT make | ALT make |
| EOT | 04 | ALT break | ALT break |
| ENQ | 05 | CTRL make | CNTRL make |
| ACK | 06 | CTRL break | CNTRL break |
| BEL | 07 | CR/Enter | RETURN |
| BS | 08 | Reserved | APPLE make |
| HT | 09 | Tab | TAB |
| LF | 0A | Reserved | APPLE break |
| VT | 0B | Tab | TAB |
| FF | 0C | Delete | Del |
| CR | 0D | CR/Enter | RETURN |
| SO | 0E | Insert | Ins Help |
| SI | 0F | Escape | ESC |
| DLE | 10 | F11 | F11 |
| DC1 | 11 | Home | Home |
| DC2 | 12 | Print | Prnt Scrn |
| DC3 | 13 | Back Space | BACKSPACE |
| DC4 | 14 | Back Tab | LSHIFT TAB |
| NAK | 15 | F12 | F12 |
| SYN | 16 | F1 | F1 |
| ETB | 17 | F2 | F2 |
| CAN | 18 | F3 | F3 |
| EM | 19 | F4 | F4 |
| SUB | 1A | F5 | F5 |
| ESC | 1B | F6 | F6 |
| FS | 1C | F7 | F7 |
| GS | 1D | F8 | F8 |
| RS | 1E | F9 | F9 |
| US | 1F | F10 | F10 |
| DEL | 7F | | BACKSPACE |



To Add a Test Code I.D. Prefix to All Symbologies

This selection allows you to turn on transmission of a Code I.D. before the decoded symbology. (See the [Symbology Charts](#), beginning on page A-1) for the single character code that identifies each symbology.) This action first clears all current prefixes, then programs a Code I.D. prefix for all symbologies. This is a temporary setting that will be removed when the unit is power cycled.



PRECA2,BK2995C80!

**Add Code I.D. Prefix to
All Symbologies (Temporary)**

Show Decoder Revision

Scan the bar code below to output the decoder revision.



REV_DR.

Show Decoder Revision

Show Scan Driver Revision

Scan the bar code below to output the scan driver revision. The scan driver controls image capture.



REV_SD.

Show Scan Driver Revision

Show Software Revision

Scan the bar code below to output the current software revision, unit serial number, and other product information for both the scanner and base.



REVINF.

Show Software Revision

Show Data Format

Scan the bar code below to show current data format settings.



DFMBK3?.

Data Format Settings

Test Menu

When you scan the Test Menu **On** code, then scan a programming code in this manual, the scanner displays the content of a programming code. The programming function will still occur, but in addition, the content of that programming code is output to the terminal.

Note: This feature should not be used during normal scanner operation.



TotalFreedom

TotalFreedom is an open system architecture that makes it possible for you create applications that reside on your scanner. Decoding apps and Data Formatting apps can be created using TotalFreedom. For further information about TotalFreedom, go to our website at www.honeywellaidc.com.

Application Plug-Ins (Apps)

Any apps that you are using can be turned off or on by scanning the following bar codes. Apps are stored in groups: Decoding, and Formatting. You can enable and disable these groups of apps by scanning that group's **On** or **Off** bar code below. You can also scan the **List Apps** bar code to output a list of all your apps.



Note: You must reset your device in order for the apps setting to take effect.

EZConfig-Scanning Introduction

EZConfig-Scanning provides a wide range of PC-based programming functions that can be performed on a scanner connected to your PC's COM port. EZConfig-Scanning allows you to download upgrades to the scanner's firmware, change programmed parameters, and create and print programming bar codes. Using EZConfig-Scanning, you can even save/open the programming parameters for a scanner. This saved file can be e-mailed or, if required, you can create a single bar code that contains all the customized programming parameters and mail or fax that bar code to any location. Users in other locations can scan the bar code to load in the customized programming.

To communicate with a scanner, EZConfig-Scanning requires that the PC have at least one available serial communication port, or a serial port emulation using a physical USB port. If you are using the serial port and RS232 cable, an external power supply is required. When using a USB serial port emulation, only a USB cable is required.

EZConfig-Scanning Operations

The EZConfig-Scanning software performs the following operations:

Scan Data

Scan Data allows you to scan bar codes and display the bar code data in a window. Scan Data lets you send serial commands to the scanner and receive scanner response that can be seen in the Scan Data window. The data displayed in the Scan Data window can either be saved in a file or printed.

Configure

Configure displays the programming and configuration data of the scanner. The scanner's programming and configuration data is grouped into different categories. Each category is displayed as a tree item under the "Configure" tree node in the application explorer. When one of these tree nodes is clicked, the right-hand side is loaded with the parameters' form belonging to that particular category. The "Configure" tree option has all the programming and configuration parameters specified for a scanner. You can set or modify these parameters as required. You can later write the modified settings to the scanner, or save them to a dcf file.

Imaging

Imaging provides all the image-related functions that a 2D Scanner can perform. You can capture an image using the current settings, and the image will be displayed in an image window. Images captured from the scanner can be saved to files in different image formats. You can modify the image settings and save the image settings to an INI file, which can be loaded later to capture new images. Imaging also lets you preview the images continuously captured by the scanner.

Installing EZConfig-Scanning from the Web

Note: EZConfig-Scanning requires .NET software. If .NET is not installed on your PC, you will be prompted to install it during the EZConfig-Scanning installation.

1. Access the Honeywell web site at www.honeywellaidc.com
2. Click on the **Resources** tab. Select **Software**.
3. Click on the dropdown for **Select Product Number**. Click on your product number.
4. Click on the listing for **EZConfig-Scanning**.
5. When prompted, select **Save File**, and save the files to the **c:\windows\temp** directory.
6. Once you have finished downloading the file, exit the web site.
7. Using Explorer, go to the **c:\windows\temp** file.
8. Double click on the **Setup.exe** file. Follow the screen prompts to install the EZConfig-Scanning program.
9. If you've selected the defaults during installation, you can click on **Start Menu-All Programs-Honeywell-EZConfig-Scanning**.

Resetting the Factory Defaults



This selection erases all your settings and resets the scanner to the original factory defaults. It also disables all plugins.

If you aren't sure what programming options are in your scanner, or you've changed some options and want to restore the scanner to factory default settings, first scan the **Remove Custom Defaults** bar code, then scan **Activate Defaults**. This resets the scanner to the factory default settings.



DEFOVR.

Remove Custom Defaults



DEFAULT.

Activate Defaults

*Note: If using a cordless system, scanning the **Activate Defaults** bar code also causes both the scanner and the base or Access Point to perform a reset and become unlinked. The scanner must be placed in its base to re-establish the link before any setup codes are entered. If using an Access Point, the linking bar code must be scanned. See [Cordless System Operation](#) beginning on page 3-1 for additional information.*

The [Menu Commands](#), beginning on page 11-4 list the factory default settings for each of the commands (indicated by an asterisk (*) on the programming pages).

Serial Programming Commands

The serial programming commands can be used in place of the programming bar codes. Both the serial commands and the programming bar codes will program the scanner. For complete descriptions and examples of each serial programming command, refer to the corresponding programming bar code in this manual.

The device must be set to an RS232 interface (see [page 2-1](#)). The following commands can be sent via a PC COM port using terminal emulation software.

Conventions

The following conventions are used for menu and query command descriptions:

parameter A label representing the actual value you should send as part of a command.

[*option*] An optional part of a command.

{*Data*} Alternatives in a command.

bold Names of menus, menu commands, buttons, dialog boxes, and windows that appear on the screen.

Menu Command Syntax

Menu commands have the following syntax (spaces have been used for clarity only):

Prefix [*:Name:*] *Tag SubTag* {*Data*} [, *SubTag* {*Data*}] [*:* *Tag SubTag* {*Data*}] [*...*] *Storage*

Prefix Three ASCII characters: **SYN M CR** (ASCII 22,77,13).

:Name: This command is only used with cordless devices. It is used to specify whether you're communicating with the base or the scanner. To send information to the scanner (with the base connected to host), use **:Xenon:** The default factory setting for a Xenon scanner is Xenon scanner. This setting is changed by using the BT_NAM command, which accepts alphanumeric values. If the name is not known, a wildcard (*) can be used **:*:**.

Note: *Since the base stores all work group settings and transfers to them to scanner once they are linked, changes are typically done to the base and not to the scanner.*

Tag A 3 character case-insensitive field that identifies the desired menu command group. For example, all RS232 configuration settings are identified with a Tag of **232**.

SubTag A 3 character case-insensitive field that identifies the desired menu command within the tag group. For example, the SubTag for the RS232 baud rate is **BAD**.

Data The new value for a menu setting, identified by the Tag and SubTag.

Storage A single character that specifies the storage table to which the command is applied. An exclamation point (!) performs the command's operation on the device's volatile menu configuration table. A period (.) performs the command's operation on the device's non-volatile menu configuration table. Use the non-volatile table only for semi-permanent changes you want saved through a power cycle.

Query Commands

Several special characters can be used to query the device about its settings.

- ^** What is the default value for the setting(s).
- ?** What is the device's current value for the setting(s).
- *** What is the range of possible values for the setting(s). (The device's response uses a dash (-) to indicate a continuous range of values. A pipe (|) separates items in a list of non-continuous values.)

:Name: Field Usage (Optional)

This command returns the query information from the scanner.

Tag Field Usage

When a query is used in place of a Tag field, the query applies to the *entire* set of commands available for the particular storage table indicated by the Storage field of the command. In this case, the SubTag and Data fields should not be used because they are ignored by the device.

SubTag Field Usage

When a query is used in place of a SubTag field, the query applies only to the subset of commands available that match the Tag field. In this case, the Data field should not be used because it is ignored by the device.

Data Field Usage

When a query is used in place of the Data field, the query applies only to the specific command identified by the Tag and SubTag fields.

Concatenation of Multiple Commands

Multiple commands can be issued within one Prefix/Storage sequence. Only the Tag, SubTag, and Data fields must be repeated for each command in the sequence. If additional commands are to be applied to the same Tag, then the new command sequence is separated with a comma (,) and only the SubTag and Data fields of the additional command are issued. If the additional command requires a different Tag field, the command is separated from previous commands by a semicolon (;).

Responses

The device responds to serial commands with one of three responses:

ACK Indicates a good command which has been processed.

ENQ Indicates an invalid Tag or SubTag command.

NAK Indicates the command was good, but the Data field entry was out of the allowable range for this Tag and SubTag combination, e.g., an entry for a minimum message length of 100 when the field will only accept 2 characters.

When responding, the device echoes back the command sequence with the status character inserted directly before each of the punctuation marks (the period, exclamation point, comma, or semicolon) in the command.

Examples of Query Commands

In the following examples, a bracketed notation [] depicts a non-displayable response.

Example: What is the range of possible values for Codabar Coding Enable?

Enter: **cbrena*.**

Response: **CBRENA0-1[ACK]**

This response indicates that Codabar Coding Enable (CBRENA) has a range of values from 0 to 1 (off and on).

Example: What is the default value for Codabar Coding Enable?

Enter: **cbrena^.**

Response: **CBRENA1[ACK]**

This response indicates that the default setting for Codabar Coding Enable (CBRENA) is 1, or on.

Example: What is the device's current setting for Codabar Coding Enable?

Enter: **cbrena?.**

Response: **CBRENA1[ACK]**

This response indicates that the device's Codabar Coding Enable (CBRENA) is set to 1, or on.

Example: What are the device's settings for all Codabar selections?

Enter: **cbr?.**

Response: **CBRENA1[ACK],**
SSX0[ACK],
CK20[ACK],
CCT1[ACK],
MIN2[ACK],
MAX60[ACK],
DFT[ACK].

This response indicates that the device's Codabar Coding Enable (CBRENA) is set to 1, or on;
the Start/Stop Character (SSX) is set to 0, or Don't Transmit;
the Check Character (CK2) is set to 0, or Not Required;
concatenation (CCT) is set to 1, or Enabled;
the Minimum Message Length (MIN) is set to 2 characters;
the Maximum Message Length (MAX) is set to 60 characters;
and the Default setting (DFT) has no value.

Trigger Commands

You can activate and deactivate the scanner with serial trigger commands. First, the scanner must be put in Manual Trigger Mode by scanning a Manual Trigger Mode bar code ([page 4-6](#)), or by sending a serial menu command for triggering ([page 4-7](#)). Once the scanner is in serial trigger mode, the trigger is activated and deactivated by sending the following commands:

Activate: **SYN T CR**

Deactivate: **SYN U CR**

The scanner scans until a bar code has been read, until the deactivate command is sent, or until the serial time-out has been reached (see "Read Time-Out" on [page 4-7](#) for a description, and the serial command on [page 11-11](#)).

Resetting the Custom Defaults

If you want the custom default settings restored to your scanner, scan the **Activate Custom Defaults** bar code below. This resets the scanner to the custom default settings. If there are no custom defaults, it will reset the scanner to the factory default settings. Any settings that have not been specified through the custom defaults will be defaulted to the factory default settings.



Activate Custom Defaults

Note: If using a cordless system, scanning this bar code also causes both the scanner and the base or Access Point to perform a reset and become unlinked. The scanner must be placed in its base to re-establish the link. If using an Access Point, the linking bar code must be scanned. See [Cordless System Operation](#) beginning on [page 3-1](#) for additional information.

The charts on the following pages list the factory default settings for each of the commands (indicated by an asterisk (*) on the programming pages).

Menu Commands

| Selection | Setting <i>* Indicates default</i> | Serial Command <i># Indicates a numeric entry</i> | Page |
|--|--|--|------|
| Product Default Settings | | | |
| Setting Custom Defaults | Set Custom Defaults | MNUCDP | 1-11 |
| | Save Custom Defaults | MNUCDS | 1-11 |
| Resetting the Custom Defaults | Activate Custom Defaults | DEFAULT | 1-11 |
| Resetting the Factory Defaults - cordless scanners | Factory Default Settings: All Application Groups | PAPDFT& | 3-20 |
| Resetting the Custom Defaults - cordless scanners | Custom Default Settings: All Application Groups | PAPDFT | 3-21 |
| Programming the Interface | | | |
| Plug and Play Codes | Keyboard Wedge: IBM PC AT and Compatibles with CR suffix | PAP_AT | 2-1 |
| | Laptop Direct Connect with CR suffix | PAPLTD | 2-1 |
| | RS232 Serial Port | PAP232 | 2-1 |
| Plug and Play Codes: RS485 | IBM Port 5B Interface | PAPP5B | 2-2 |
| | IBM Port 9B HHBCR-1 Interface | PAP9B1 | 2-2 |
| | IBM Port 17 Interface | PAPP17 | 2-2 |
| | IBM Port 9B HHBCR-2 Interface | PAP9B2 | 2-2 |
| | RS485 Packet Mode On | RTLPDF1 | 2-2 |
| | RS485 Packet Mode Off | RTLPDF0 | 2-2 |
| Plug and Play Codes: IBM SurePos | RS485 Packet Length (20-256) | RTLMP5 | 2-3 |
| | USB IBM SurePos Handheld | PAPSPH | 2-3 |
| Plug and Play Codes: USB | USB IBM SurePos Tabletop | PAPSPT | 2-3 |
| | USB Keyboard (PC) | PAP124 | 2-3 |
| | USB Keyboard (Mac) | PAP125 | 2-3 |
| | USB Japanese Keyboard (PC) | TRMUSB134 | 2-3 |
| | USB HID | PAP131 | 2-4 |
| | USB Serial | TRMUSB130 | 2-4 |
| | CTS/RTS Emulation On | USBCTS1 | 2-4 |
| | CTS/RTS Emulation Off* | USBCTS0 | 2-4 |
| | ACK/NAK Mode On | USBACK1 | 2-4 |
| ACK/NAK Mode Off* | USBACK0 | 2-4 | |
| Remote MasterMind for USB | ReM Off | REMIFC0 | 2-4 |
| | ReM On | REMIFC1 | 2-4 |
| Plug and Play Codes | Verifone Ruby Terminal | PAPRBY | 2-5 |
| | Gilbarco Terminal | PAPGLB | 2-5 |
| | Honeywell Bioptic Aux Port | PAPBIO | 2-5 |
| | Datalogic Magellan Aux Port | PAPMAG | 2-6 |
| | NCR Bioptic Aux Port | PAPNCR | 2-6 |
| | Wincor Nixdorf Terminal | PAPWNX | 2-6 |
| | Wincor Nixdorf Beetle | PAPBTL | 2-6 |

| Selection | Setting <i>* Indicates default</i> | Serial Command <i># Indicates a numeric entry</i> | Page |
|-----------------------------|--|---|----------------------|
| Program Keyboard Country | *U.S.A. | KBDCTY0 | 2-7 |
| | Albania | KBDCTY35 | 2-7 |
| | Azeri (Cyrillic) | KBDCTY81 | 2-7 |
| | Azeri (Latin) | KBDCTY80 | 2-7 |
| | Belarus | KBDCTY82 | 2-7 |
| | Belgium | KBDCTY1 | 2-7 |
| | Bosnia | KBDCTY33 | 2-7 |
| | Brazil | KBDCTY16 | 2-7 |
| | Brazil (MS) | KBDCTY59 | 2-7 |
| | Bulgaria (Cyrillic) | KBDCTY52 | 2-8 |
| | Bulgaria (Latin) | KBDCTY53 | 2-8 |
| | Canada (French legacy) | KBDCTY54 | 2-8 |
| | Canada (French) | KBDCTY18 | 2-8 |
| | Canada (Multilingual) | KBDCTY55 | 2-8 |
| | Croatia | KBDCTY32 | 2-8 |
| | Czech | KBDCTY15 | 2-8 |
| | Czech (Programmers) | KBDCTY40 | 2-8 |
| | Czech (QWERTY) | KBDCTY39 | 2-8 |
| | Czech (QWERTZ) | KBDCTY38 | 2-8 |
| | Denmark | KBDCTY8 | 2-8 |
| | Dutch (Netherlands) | KBDCTY11 | 2-9 |
| | Estonia | KBDCTY41 | 2-9 |
| | Faroese | KBDCTY83 | 2-9 |
| | Finland | KBDCTY2 | 2-9 |
| | France | KBDCTY3 | 2-9 |
| | Gaelic | KBDCTY84 | 2-9 |
| | Germany | KBDCTY4 | 2-9 |
| | Greek | KBDCTY17 | 2-9 |
| | Greek (220 Latin) | KBDCTY64 | 2-9 |
| | Greek (220) | KBDCTY61 | 2-9 |
| | Greek (319 Latin) | KBDCTY65 | 2-9 |
| | Greek (319) | KBDCTY62 | 2-10 |
| | Greek (Latin) | KBDCTY63 | 2-10 |
| | Greek (MS) | KBDCTY66 | 2-10 |
| | Greek (Polytonic) | KBDCTY60 | 2-10 |
| | Hebrew | KBDCTY12 | 2-10 |
| | Hungarian (101 key) | KBDCTY50 | 2-10 |
| | Hungary | KBDCTY19 | 2-10 |
| | Iceland | KBDCTY75 | 2-10 |
| | Irish | KBDCTY73 | 2-10 |
| Italian (142) | KBDCTY56 | 2-10 | |
| Italy | KBDCTY5 | 2-10 | |

| Selection | Setting <i>* Indicates default</i> | Serial Command <i># Indicates a numeric entry</i> | Page |
|-----------|---------------------------------------|--|----------------------|
| | Japan ASCII | KBDCTY28 | 2-11 |
| | Kazakh | KBDCTY78 | 2-11 |
| | Kyrgyz (Cyrillic) | KBDCTY79 | 2-11 |
| | Latin America | KBDCTY14 | 2-11 |
| | Latvia | KBDCTY42 | 2-11 |
| | Latvia (QWERTY) | KBDCTY43 | 2-11 |
| | Lithuania | KBDCTY44 | 2-11 |
| | Lithuania (IBM) | KBDCTY45 | 2-11 |
| | Macedonia | KBDCTY34 | 2-11 |
| | Malta | KBDCTY74 | 2-11 |
| | Mongolian (Cyrillic) | KBDCTY86 | 2-11 |
| | Norway | KBDCTY9 | 2-12 |
| | Poland | KBDCTY20 | 2-12 |
| | Polish (214) | KBDCTY57 | 2-12 |
| | Polish (Programmers) | KBDCTY58 | 2-12 |
| | Portugal | KBDCTY13 | 2-12 |
| | Romania | KBDCTY25 | 2-12 |
| | Russia | KBDCTY26 | 2-12 |
| | Russian (MS) | KBDCTY67 | 2-12 |
| | Russian (Typewriter) | KBDCTY68 | 2-12 |
| | SCS | KBDCTY21 | 2-12 |
| | Serbia (Cyrillic) | KBDCTY37 | 2-12 |
| | Serbia (Latin) | KBDCTY36 | 2-13 |
| | Slovakia | KBDCTY22 | 2-13 |
| | Slovakia (QWERTY) | KBDCTY49 | 2-13 |
| | Slovakia (QWERTZ) | KBDCTY48 | 2-13 |
| | Slovenia | KBDCTY31 | 2-13 |
| | Spain | KBDCTY10 | 2-13 |
| | Spanish variation | KBDCTY51 | 2-13 |
| | Sweden | KBDCTY23 | 2-13 |
| | Switzerland (French) | KBDCTY29 | 2-13 |
| | Switzerland (German) | KBDCTY6 | 2-13 |
| | Tatar | KBDCTY85 | 2-13 |
| | Turkey F | KBDCTY27 | 2-14 |
| | Turkey Q | KBDCTY24 | 2-14 |
| | Ukrainian | KBDCTY76 | 2-14 |
| | United Kingdom | KBDCTY7 | 2-14 |
| | United States (Dvorak right) | KBDCTY89 | 2-14 |
| | United States (Dvorak left) | KBDCTY88 | 2-14 |
| | United States (Dvorak) | KBDCTY87 | 2-14 |
| | United States (International) | KBDCTY30 | 2-14 |
| | Uzbek (Cyrillic) | KBDCTY77 | 2-14 |

| Selection | Setting <i>* Indicates default</i> | Serial Command <i># Indicates a numeric entry</i> | Page |
|---|--|---|----------------------|
| Keyboard Conversion | *Keyboard Conversion Off | KBDCNV0 | 2-15 |
| | Convert all Characters to Upper Case | KBDCNV1 | 2-16 |
| | Convert all Characters to Lower Case | KBDCNV2 | 2-16 |
| Keyboard Style | *Regular | KBDSTY0 | 2-14 |
| | Caps Lock | KBDSTY1 | 2-15 |
| | Shift Lock | KBDSTY2 | 2-15 |
| | Automatic Caps Lock | KBDSTY6 | 2-15 |
| | Emulate External Keyboard | KBDSTY5 | 2-15 |
| Control Character Output | *Control Character Output Off | KBDNPE0 | 2-16 |
| | *Control Character Output On | KBDNPE1 | 2-16 |
| Keyboard Modifiers | *Control + X Off | KBDCAS0 | 2-16 |
| | DOS Mode Control + X | KBDCAS1 | 2-16 |
| | Windows Mode Control + X | KBDCAS2 | 2-16 |
| | Windows Mode Prefix/Suffix Off | KBDCAS3 | 2-17 |
| | *Turbo Mode Off | KBDTMD0 | 2-17 |
| | Turbo Mode On | KBDTMD1 | 2-17 |
| | *Numeric Keypad Off | KBDNPS0 | 2-17 |
| | Numeric Keypad On | KBDNPS1 | 2-17 |
| | *Auto Direct Connect Off | KBDADC0 | 2-17 |
| | Auto Direct Connect On | KBDADC1 | 2-17 |
| Baud Rate | 300 BPS | 232BAD0 | 2-18 |
| | 600 BPS | 232BAD1 | 2-18 |
| | 1200 BPS | 232BAD2 | 2-18 |
| | 2400 BPS | 232BAD3 | 2-18 |
| | 4800 BPS | 232BAD4 | 2-18 |
| | 9600 BPS | 232BAD5 | 2-18 |
| | 19200 BPS | 232BAD6 | 2-18 |
| | 38400 BPS | 232BAD7 | 2-18 |
| | 57600 BPS | 232BAD8 | 2-18 |
| | *115200 BPS | 232BAD9 | 2-18 |
| Word Length: Data Bits, Stop Bits, and Parity | 7 Data, 1 Stop, Parity Even | 232WRD3 | 2-19 |
| | 7 Data, 1 Stop, Parity None | 232WRD0 | 2-19 |
| | 7 Data, 1 Stop, Parity Odd | 232WRD6 | 2-19 |
| | 7 Data, 2 Stop, Parity Even | 232WRD4 | 2-19 |
| | 7 Data, 2 Stop, Parity None | 232WRD1 | 2-19 |
| | 7 Data, 2 Stop, Parity Odd | 232WRD7 | 2-19 |
| | 8 Data, 1 Stop, Parity Even | 232WRD5 | 2-19 |
| | *8 Data, 1 Stop, Parity None | 232WRD2 | 2-19 |
| | 8 Data, 1 Stop, Parity Odd | 232WRD8 | 2-19 |
| | 8 Data, 1 Stop, Parity Mark | 232WRD14 | 2-19 |

| Selection | Setting <i>* Indicates default</i> | Serial Command <i># Indicates a numeric entry</i> | Page |
|---|--|---|----------------------|
| RS232 Receiver Time-out | Range 0 - 300 seconds | 232LPT### | 2-20 |
| RS232 Handshaking | *RTS/CTS Off | 232CTS0 | 2-20 |
| | Flow Control, No Timeout | 232CTS1 | 2-20 |
| | Two-Direction Flow Control | 232CTS2 | 2-20 |
| | Flow Control with Timeout | 232CTS3 | 2-20 |
| | RS232 Timeout | 232DEL#### | 2-20 |
| | *XON/XOFF Off | 232XON0 | 2-21 |
| | XON/XOFF On | 232XON1 | 2-21 |
| | *ACK/NAK Off | 232ACK0 | 2-21 |
| ACK/NAK On | 232ACK1 | 2-21 | |
| Scanner-Biopic Packet Mode | *Packet Mode Off | 232PKT0 | 2-21 |
| | Packet Mode On | 232PKT2 | 2-2 |
| Scanner-Biopic ACK/NAK Mode | *Biopic ACK/NAK Off | 232NAK0 | 2-22 |
| | Biopic ACK/NAK On | 232NAK1 | 2-22 |
| Scanner-Biopic ACK/NAK Timeout | ACK/NAK Timeout *5100 | 232DLK##### | 2-22 |
| <i>Cordless System Operation</i> | | | |
| <i>Note: This section applies only to cordless systems. It does not apply to corded scanners.</i> | | | |
| Base Power Communication Indicator | *On | .*:BASRED1 | 3-5 |
| | Off | .*:BASRED0 | 3-5 |
| Reset Scanner | Reset Scanner | RESET_ | 3-6 |
| Scanning While in Base Cradle | Scanning in Cradle Off | BT_SIC0 | 3-6 |
| | *Scanning in Cradle On (CCB01-010BT default) | BT_SIC1 | 3-6 |
| | Shut Down Scanner in Cradle | BT_SIC2 | 3-6 |
| Base Charging Modes | Base Charge Off | BASCHG0 | 3-7 |
| | *External or Interface Cable Power | BASCHG1 | 3-7 |
| | External Power Only | BASCHG2 | 3-7 |
| Paging Mode | *On | BEPPGE1 | 3-7 |
| | Off | BEPPGE0 | 3-7 |
| Paging Pitch | Range 400 - 9000 Hz (*1000) | BEPPFQ#### | 3-7 |
| Beeper Pitch - Base Error | *Razz (250) (min 200Hz) | BASFQ2250 | 3-8 |
| | Medium (3250) | BASFQ23250 | 3-8 |
| | High (4200) (max 9000Hz) | BASFQ24200 | 3-8 |
| Number of Beeps - Base Error | *1 | BASERR3 | 3-8 |
| | Range 1 - 9 | BASERR# | 3-8 |
| Scanner Report | Scanner Report | RPTSCN | 3-8 |
| Scanner Address | Scanner Address | BT_LDA | 3-9 |
| Base Address | Base Address | .*:BASLDA | 3-9 |

| Selection | Setting <i>* Indicates default</i> | Serial Command <i># Indicates a numeric entry</i> | Page |
|------------------------------|--|---|-------------|
| Scanner Modes | Charge Only Mode | ∗:BASLNK0 | 3-9 |
| | *Charge and Link Mode | ∗:BASLNK1 | 3-9 |
| | Locked Link Mode | BASCON0,DNG1 | 3-10 |
| | *Open Link Mode | BASCON1,DNG1 | 3-10 |
| | Unlink Scanner | BT_RMV | 3-10 |
| | Override Locked Scanner | BT_RPL1 | 3-10 |
| Out-of-Range Alarm | Base Alarm Duration (Range 1 - 3000 sec (*0)) | BASORD | 3-11 |
| | Scanner Alarm Duration (Range 1 - 3000 sec (*0)) | BT_ORD | 3-11 |
| Alarm Sound Type | Base Alarm Type | BASORW | 3-11 |
| | Scanner Alarm Type | BT_ORW | 3-11 |
| Scanner Power Time-Out Timer | Timer (0-7200 seconds) | BT_LPT0 | 3-12 |
| | 200 Seconds | BT_LPT200 | 3-12 |
| | 400 Seconds | BT_LPT400 | 3-12 |
| | 900 Seconds | BT_LPT900 | 3-12 |
| | 3600 Seconds | BT_LPT3600 | 3-12 |
| | 7200 Seconds | BT_LPT7200 | 3-12 |
| Flexible Power Management | *Full Power | BT_TXP100 | 3-13 |
| | Medium Power | BT_TXP35 | 3-13 |
| | Medium Low Power | BT_TXP5 | 3-13 |
| | Low Power | BT_TXP1 | 3-13 |
| Batch Mode | Automatic Batch Mode | BATENA1 | 3-13 |
| | *Batch Mode Off | BATENA0 | 3-13 |
| | Inventory Batch Mode | BATENA2 | 3-14 |
| | Persistent Batch Mode | BATENA3 | 3-14 |
| Batch Mode Beep | Off | BATBEP0 | 3-14 |
| | *On | BATBEP1 | 3-14 |
| Batch Mode Storage | *Flash Storage | BATNVS1 | 3-14 |
| | RAM Storage | BATNVS0 | 3-14 |
| Batch Mode Quantity | *Off | BATQTY0 | 3-15 |
| | On | BATQTY1 | 3-15 |
| Quantity Codes | 0 | BATNUM0 | 3-15 |
| | *1 | BATNUM1 | 3-16 |
| | 2 | BATNUM2 | 3-16 |
| | 3 | BATNUM3 | 3-16 |
| | 4 | BATNUM4 | 3-16 |
| | 5 | BATNUM5 | 3-16 |
| | 6 | BATNUM6 | 3-16 |
| | 7 | BATNUM7 | 3-16 |
| | 8 | BATNUM8 | 3-16 |
| 9 | BATNUM9 | 3-16 | |

| Selection | Setting <i>* Indicates default</i> | Serial Command <i># Indicates a numeric entry</i> | Page |
|---|--|---|-------------|
| Batch Mode Output Order | *FIFO | BATLIF0 | 3-16 |
| | LIFO | BATLIF1 | 3-16 |
| Total Records | Total Records | BATNRC | 3-17 |
| Delete Last Code | Delete Last Code | BATUND | 3-17 |
| Clear All Codes | Clear All Codes | BATCLR | 3-17 |
| Transmit Records to Host | Transmit Inventory Records | BAT_TX | 3-17 |
| Batch Mode Transmit Delay | *Off | BATDLY0 | 3-17 |
| | Short (ms) | BATDLY250 | 3-17 |
| | Medium (ms) | BATDLY500 | 3-18 |
| | Long (ms) | BATDLY1000 | 3-18 |
| Multiple Scanner Operation | Multiple Scanner Operation | BASCON2,DNG3 | 3-18 |
| Scanner Name | Name 1-7 | BT_NAM##### | 3-18 |
| | Reset | RESET_ | 3-19 |
| | Scanner Name | BT_NAM | 3-19 |
| Application Work Group Selections | *Group 0 | GRPSEL0 | 3-20 |
| | Group 1-6 | GRPSEL# | 3-20 |
| Resetting the Factory Defaults: All Application Work Groups | Factory Default Settings: All Work Groups | PAPDFT& | 3-20 |
| Resetting the Custom Defaults: All Application Work Groups | Custom Default Settings: All Work Groups | PAPDFT | 3-21 |
| Bluetooth Connection | Bluetooth HID Keyboard Connect | PAPBTH | 3-21 |
| | Bluetooth HID Keyboard Disconnect | PAPSPP | 3-23 |
| | Bluetooth Serial Port - PCs/ Laptops | BT_TRM0;BT_DNG5 | 3-23 |
| | BT Connection - PDA/Mobility Systems Device | BT_TRM0;BT_DNG1 | 3-23 |
| | Bluetooth PIN Code | BT_PIN | 3-23 |
| Bluetooth PIN Code | Bluetooth PIN | BT_PIN | 3-23 |
| Auto Reconnect Mode | *Auto Reconnect On | BT_ACM1 | 3-24 |
| | Auto Reconnect Off | BT_ACM0 | 3-24 |
| Maximum Link Attempts | Maximum Link Attempts | BT_MLA | 3-25 |
| Relink Time-Out | Relink Time-Out | BT_RLT | 3-25 |
| Host Command Acknowledgment | Host ACK On | HSTACK1 | 3-27 |
| | *Host ACK Off | HSTACK0 | 3-27 |
| <i>Input/Output Selections</i> | | | |
| Power Up Beeper | Power Up Beeper Off - Scanner | BEPPWR0 | 4-1 |
| | *Power Up Beeper On - Scanner | BEPPWR1 | 4-1 |
| | Power Up Beeper Off - Cordless Base | BASPWR0 | 4-1 |
| | Power Up Beeper On - Cordless Base | BASPWR1 | 4-1 |

| Selection | Setting <i>* Indicates default</i> | Serial Command <i># Indicates a numeric entry</i> | Page |
|--------------------------------------|--|---|-------------|
| Beep on BEL Character | Beep on BEL On | BELBEP1 | 4-1 |
| | *Beep on BEL Off | BELBEP0 | 4-1 |
| Trigger Click | On | BEPTRG1 | 4-2 |
| | *Off | BEPTRG0 | 4-2 |
| Beeper - Good Read | Off | BEPBEP0 | 4-2 |
| | *On | BEPBEP1 | 4-2 |
| Beeper Volume - Good Read | Off | BEPLVL0 | 4-2 |
| | Low | BEPLVL1 | 4-2 |
| | Medium | BEPLVL2 | 4-2 |
| | *High | BEPLVL3 | 4-2 |
| Beeper Pitch - Good Read (Frequency) | Low (1600) (min 400Hz) | BEPFQ11600 | 4-3 |
| | *Medium - Xenon (2700 Hz) | BEPFQ12700 | 4-3 |
| | *Medium - Granit (3200 Hz) | BEPFQ13200 | 4-3 |
| | High (4200) (max 9000Hz) | BEPFQ14200 | 4-3 |
| Vibrate - Good Read | Vibrate - Good Read Off | TFBGRD0 | 4-3 |
| | *Vibrate - Good Read On | TFBGRD1 | 4-3 |
| Vibrate Duration | Duration (100 - 2,000 ms) *300 | TFBDUR#### | 4-3 |
| Beeper Pitch - Error (Frequency) | *Razz (250) (min 200Hz) | BEPFQ2800 | 4-4 |
| | Medium (3250) | BEPFQ23250 | 4-4 |
| | High (4200) (max 9000Hz) | BEPFQ24200 | 4-4 |
| Beeper Duration - Good Read | *Normal Beep | BEPBIP0 | 4-4 |
| | Short Beep | BEPBIP1 | 4-4 |
| LED - Good Read | Off | BEPLD0 | 4-4 |
| | *On | BEPLD1 | 4-4 |
| Number of Beeps - Error | *1 | BEPERR3 | 4-5 |
| | Range 1 - 9 | BEPERR# | 4-5 |
| Number of Beeps - Good Read | *1 | BEPRPT1 | 4-5 |
| | Range 1 - 9 | BEPRPT# | 4-5 |
| Beeper Volume Max | Beeper Volume Max | PAPBLM | 4-5 |
| Good Read Delay | *No Delay | DLYGRD0 | 4-5 |
| | Short Delay (500 ms) | DLYGRD500 | 4-5 |
| | Medium Delay (1000 ms) | DLYGRD1000 | 4-5 |
| | Long Delay (1500 ms) | DLYGRD1500 | 4-6 |
| User-Specified Good Read Delay | Range 0 - 30,000 ms | DLYGRD##### | 4-6 |
| Manual Trigger Modes | *Manual Trigger - Normal | PAPHHF | 4-6 |
| | Manual Trigger - Enhanced | PAPHHS | 4-6 |
| LED Illumination - Manual Trigger | Off | PWRNOL0 | 4-6 |
| | Low | PWRNOL100 | 4-6 |
| | Medium (Xenon only) | PWRNOL120 | 4-6 |
| | *High | PWRNOL150 | 4-6 |
| Serial Trigger Mode | Read Time-Out (0 - 300,000 ms) *30,000 | TRGSTO#### | 4-7 |

| Selection | Setting <i>* Indicates default</i> | Serial Command <i># Indicates a numeric entry</i> | Page |
|--|--|---|-------------|
| Presentation Mode | Presentation Mode | PAPTPR | 4-7 |
| LED Illumination - Presentation Mode | Off | PWRLDC0 | 4-8 |
| | Low | PWRLDC100 | 4-8 |
| | *High | PWRLDC150 | 4-8 |
| Presentation LED Behavior After Decode | *LEDs On | TRGPCK1 | 4-8 |
| | LEDs Off | TRGPCK0 | 4-8 |
| Presentation Sensitivity | Range 0-20 (*1) | TRGPMS## | 4-8 |
| Presentation Centering Window | Presentation Centering On | PDCWIN1 | 4-9 |
| | *Presentation Centering Off | PDCWIN0 | 4-9 |
| | Left of Presentation Centering Window (*40%) | PDCLFT### | 4-10 |
| | Right of Presentation Centering Window (*60%) | PDCRGT### | 4-10 |
| | Top of Presentation Centering Window (*40%) | PDCTOP### | 4-9 |
| | Bottom of Presentation Centering Window (*60%) | PDCBOT### | 4-10 |
| In-Stand Sensor Mode | Sensor On | TRGSSW1 | 4-10 |
| | Sensor Off | TRGSSW0 | 4-10 |
| CodeGate | *CodeGate Off Out-of-Stand | AOSCGD0. | 4-10 |
| | CodeGate On Out-of-Stand | AOSCGD1. | 4-11 |
| Streaming Presentation | Streaming Presentation Mode - Normal | PAPSPN | 4-11 |
| | Streaming Presentation Mode - Enhanced | PAPSPE | 4-11 |
| Mobile Phone Read Mode | Hand Held Scanning - Mobile Phone | PAPHHC | 4-11 |
| | Streaming Presentation - Mobile Phone | PAPSPC | 4-11 |
| Hands Free Time-Out | Range 0 - 300,000 ms | TRGPTO##### | 4-12 |
| Reread Delay | Short (500 ms) | DLYRRD500 | 4-12 |
| | *Medium (750 ms) | DLYRRD750 | 4-12 |
| | Long (1000 ms) | DLYRRD1000 | 4-12 |
| | Extra Long (2000 ms) | DLYRRD2000 | 4-12 |
| User-Specified | Range 0 - 30,000 ms | DLYRRD##### | 4-12 |
| 2D Reread Delay | *2D Reread Delay Off | DLY2RR0 | 4-13 |
| | Short (1000ms) | DLY2RR1000 | 4-13 |
| | Medium (2000ms) | DLY2RR2000 | 4-13 |
| | Long (3000ms) | DLY2RR3000 | 4-13 |
| | Extra Long (4000ms) | DLY2RR4000 | 4-13 |

| Selection | Setting <i>* Indicates default</i> | Serial Command <i># Indicates a numeric entry</i> | Page |
|-----------------------------|---|---|----------------------|
| Character Activation Mode | *Off | HSTCEN0 | 4-13 |
| | On | HSTCEN1 | 4-13 |
| | Activation Character (Range 0-255) *12 [DC2] | HSTACH### | 4-14 |
| | *Do Not End Character Activation After Good Read | HSTCGD0 | 4-14 |
| | End Character Activation After Good Read | HSTCGD1 | 4-14 |
| | Character Activation Timeout (Range 1 - 300,000) *30,000 ms | HSTCDT##### | 4-14 |
| Character Deactivation Mode | *Off | HSTDEN0 | 4-14 |
| | On | HSTDEN1 | 4-14 |
| | Deactivation Character (Range 0-255) *14 [DC4] | HSTDCH### | 4-15 |
| Illumination Lights | *Lights On | SCNLED1 | 4-15 |
| | Lights Off | SCNLED0 | 4-15 |
| Aimer Delay | 200 milliseconds | SCNDLY200 | 4-15 |
| | 400 milliseconds | SCNDLY400 | 4-15 |
| | *Off (no delay) | SCNDLY0 | 4-15 |
| User-Specified Aimer Delay | Range 0 - 4,000 ms | SCNDLY#### | 4-16 |
| Aimer Mode | Off | SCNAIM0 | 4-16 |
| | *Interlaced | SCNAIM2 | 4-16 |
| Centering Window | Centering On | DECWIN1 | 4-17 |
| | *Centering Off | DECWIN0 | 4-17 |
| | Left of Centering Window (*40%) | DECLFT### | 4-17 |
| | Right of Centering Window (*60%) | DECRGT### | 4-18 |
| | Top of Centering Window (*40%) | DECTOP### | 4-17 |
| | Bottom of Centering Window (*60%) | DECBOT### | 4-17 |
| Preferred Symbology | On | PRFENA1 | 4-18 |
| | *Off | PRFENA0 | 4-18 |
| | High Priority Symbology | PRFCOD## | 4-18 |
| | Low Priority Symbology | PRFBLK## | 4-19 |
| | Preferred Symbology Timeout (*500) Range 100-3000 | PRFPTO#### | 4-19 |
| | Preferred Symbology Default | PRFDFT | 4-19 |
| Output Sequence Editor | Enter Sequence | SEQBLK | 4-21 |
| | Default Sequence | SEQDFT | 4-21 |
| Partial Sequence | Transmit Partial Sequence | SEQTTS1 | 4-21 |
| | *Discard Partial Sequence | SEQTTS0 | 4-21 |
| Require Output Sequence | Required | SEQ_EN2 | 4-22 |
| | On/Not Required | SEQ_EN1 | 4-22 |
| | *Off | SEQ_EN0 | 4-22 |

| Selection | Setting <i>* Indicates default</i> | Serial Command <i># Indicates a numeric entry</i> | Page |
|-------------------------------------|--|---|----------------------|
| Multiple Symbols | On | SHOTGN1 | 4-22 |
| | *Off | SHOTGN0 | 4-22 |
| No Read | On | SHWNRD1 | 4-22 |
| | *Off | SHWNRD0 | 4-22 |
| Video Reverse | Video Reverse Only | VIDREV1 | 4-23 |
| | Video Reverse and Standard Bar Codes | VIDREV2 | 4-23 |
| | *Video Reverse Off | VIDREV0 | 4-23 |
| Working Orientation | *Upright | ROTATN0 | 4-24 |
| | Vertical, Bottom to Top (Rotate CCW 90°) | ROTATN1 | 4-24 |
| | Upside Down | ROTATN2 | 4-24 |
| | Vertical, Top to Bottom (Rotate CW 90°) | ROTATN3 | 4-24 |
| Prefix/Suffix Selections | | | |
| Add CR Suffix to All Symbologies | | VSUF CR | 5-2 |
| Prefix | Add Prefix | PREBK2## | 5-2 |
| | Clear One Prefix | PRECL2 | 5-2 |
| | Clear All Prefixes | PRECA2 | 5-2 |
| Suffix | Add Suffix | SUFBK2## | 5-2 |
| | Clear One Suffix | SUFCL2 | 5-2 |
| | Clear All Suffixes | SUFCA2 | 5-2 |
| Function Code Transmit | *Enable | RMVFNC0 | 5-3 |
| | Disable | RMVFNC1 | 5-3 |
| Intercharacter Delay | Range 0 - 1000 (5ms increments) | DLYCHR## | 5-3 |
| User Specified Intercharacter Delay | Delay Length 0 - 1000 (5ms increments) | DLYCRX## | 5-4 |
| | Character to Trigger Delay | DLY_XX## | 5-4 |
| Interfunction Delay | Range 0 - 1000 (5ms increments) | DLYFNC## | 5-4 |
| Intermessage Delay | Range 0 - 1000 (5ms increments) | DLYMSG## | 5-4 |
| Data Formatter Selections | | | |
| Data Format Editor | *Default Data Format (None) | DFMDF3 | 6-1 |
| | Enter Data Format | DFMBK3## | 6-2 |
| | Clear One Data Format | DFMCL3 | 6-2 |
| | Clear All Data Formats | DFMCA3 | 6-2 |

| Selection | Setting <i>* Indicates default</i> | Serial Command <i># Indicates a numeric entry</i> | Page |
|----------------------------------|--|---|-------------|
| Data Formatter | Data Formatter Off | DFM_EN0 | 6-12 |
| | *Data Formatter On, Not Required, Keep Prefix/Suffix | DFM_EN1 | 6-12 |
| | Data Format Required, Keep Prefix/Suffix | DFM_EN2 | 6-12 |
| | Data Formatter On, Not Required, Drop Prefix/Suffix | DFM_EN3 | 6-12 |
| | Data Format Required, Drop Prefix/Suffix | DFM_EN4 | 6-12 |
| Data Format Non-Match Error Tone | *Data Format Non-Match Error Tone On | DFMDEC0 | 6-13 |
| | Data Format Non-Match Error Tone Off | DFMDEC1 | 6-13 |
| Primary/Alternate Data Formats | Primary Data Format | ALTFNM0 | 6-13 |
| | Data Format 1 | ALTFNM1 | 6-13 |
| | Data Format 2 | ALTFNM2 | 6-13 |
| | Data Format 3 | ALTFNM3 | 6-13 |
| Single Scan Data Format Change | Single Scan-Primary Data Format | VSAF_0 | 6-14 |
| | Single Scan-Data Format 1 | VSAF_1 | 6-14 |
| | Single Scan-Data Format 2 | VSAF_2 | 6-14 |
| | Single Scan-Data Format 3 | VSAF_3 | 6-14 |
| Symbologies | | | |
| All Symbologies | All Symbologies Off | ALLENA0 | 7-1 |
| | All Symbologies On | ALLENA1 | 7-1 |
| Codabar | Default All Codabar Settings | CBRDFT | 7-2 |
| | Off | CBRENA0 | 7-2 |
| | *On | CBRENA1 | 7-2 |
| Codabar Start/Stop Char. | *Don't Transmit | CBRSSX0 | 7-2 |
| | Transmit | CBRSSX1 | 7-2 |
| Codabar Check Char. | *No Check Char. | CBRCK20 | 7-2 |
| | Validate, But Don't Transmit | CBRCK21 | 7-2 |
| | Validate, and Transmit | CBRCK22 | 7-2 |
| Codabar Concatenation | *Off | CBRCCT0 | 7-3 |
| | On | CBRCCT1 | 7-3 |
| | Require | CBRCCT2 | 7-3 |
| Codabar Message Length | Minimum (2 - 60) *4 | CBRMIN## | 7-3 |
| | Maximum (2 - 60) *60 | CBRMAX## | 7-3 |
| Code 39 | Default All Code 39 Settings | C39DFT | 7-4 |
| | Off | C39ENA0 | 7-4 |
| | *On | C39ENA1 | 7-4 |

| Selection | Setting <i>* Indicates default</i> | Serial Command <i># Indicates a numeric entry</i> | Page |
|-----------------------------------|--|---|-------------|
| Code 39 Start/Stop Char. | *Don't Transmit | C39SSX0 | 7-4 |
| | Transmit | C39SSX1 | 7-4 |
| Code 39 Check Char. | *No Check Char. | C39CK20 | 7-4 |
| | Validate, But Don't Transmit | C39CK21 | 7-4 |
| | Validate, and Transmit | C39CK22 | 7-4 |
| Code 39 Message Length | Minimum (0 - 48) *0 | C39MIN## | 7-5 |
| | Maximum (0 - 48) *48 | C39MAX## | 7-5 |
| Code 39 Append | *Off | C39APP0 | 7-5 |
| | On | C39APP1 | 7-5 |
| Code 32 Pharmaceutical (PARAF) | *Off | C39B320 | 7-5 |
| | On | C39B321 | 7-5 |
| Code 39 Full ASCII | *Off | C39ASC0 | 7-6 |
| | On | C39ASC1 | 7-6 |
| | Code 39 Code Page | C39DCP | 7-6 |
| Interleaved 2 of 5 | Default All Interleaved 2 of 5 Settings | I25DFT | 7-7 |
| | Off | I25ENA0 | 7-7 |
| | *On | I25ENA1 | 7-7 |
| Interleaved 2 of 5 Check Digit | *No Check Char. | I25CK20 | 7-7 |
| | Validate, But Don't Transmit | I25CK21 | 7-7 |
| | Validate, and Transmit | I25CK22 | 7-7 |
| Interleaved 2 of 5 Message Length | Minimum (2 - 80) *4 | I25MIN## | 7-7 |
| | Maximum (2 - 80) *80 | I25MAX## | 7-7 |
| NEC 2 of 5 | Default All NEC 2 of 5 Settings | N25DFT | 7-8 |
| | Off | N25ENA0 | 7-8 |
| | *On | N25ENA1 | 7-8 |
| NEC 2 of 5 Check Digit | *No Check Char. | N25CK20 | 7-8 |
| | Validate, But Don't Transmit | N25CK21 | 7-8 |
| | Validate, and Transmit | N25CK22 | 7-8 |
| NEC 2 of 5 Message Length | Minimum (2 - 80) *4 | N25MIN## | 7-9 |
| | Maximum (2 - 80) *80 | N25MAX## | 7-9 |
| Code 93 | Default All Code 93 Settings | C93DFT | 7-9 |
| | Off | C93ENA0 | 7-9 |
| | *On | C93ENA1 | 7-9 |
| Code 93 Message Length | Minimum (0 - 80) *0 | C93MIN## | 7-9 |
| | Maximum (0 - 80) *80 | C93MAX## | 7-9 |
| Code 93 Append | On | C93APP1 | 7-10 |
| | *Off | C93APP0 | 7-10 |

| Selection | Setting <i>* Indicates default</i> | Serial Command <i># Indicates a numeric entry</i> | Page |
|---|---|---|----------------------|
| Code 93 Code Page | Code 93 Code Page | C93DCP | 7-10 |
| Straight 2 of 5 Industrial | Default All Straight 2 of 5 Industrial Settings | R25DFT | 7-11 |
| | *Off | R25ENA0 | 7-11 |
| | On | R25ENA1 | 7-11 |
| Straight 2 of 5 Industrial Message Length | Minimum (1 - 48) *4 | R25MIN## | 7-11 |
| | Maximum (1 - 48) *48 | R25MAX## | 7-11 |
| Straight 2 of 5 IATA | Default All Straight 2 of 5 IATA Settings | A25DFT | 7-12 |
| Straight 2 of 5 IATA | *Off | A25ENA0 | 7-12 |
| | On | A25ENA1 | 7-12 |
| Straight 2 of 5 IATA Message Length | Minimum (1 - 48) *4 | A25MIN## | 7-12 |
| | Maximum (1 - 48) *48 | A25MAX## | 7-12 |
| Matrix 2 of 5 | Default All Matrix 2 of 5 Settings | X25DFT | 7-13 |
| | *Off | X25ENA0 | 7-13 |
| | On | X25ENA1 | 7-13 |
| Matrix 2 of 5 Message Length | Minimum (1 - 80) *4 | X25MIN## | 7-13 |
| | Maximum (1 - 80) *80 | X25MAX## | 7-13 |
| Code 11 | Default All Code 11 Settings | C11DFT | 7-14 |
| | *Off | C11ENA0 | 7-14 |
| | On | C11ENA1 | 7-14 |
| Code 11 Check Digits Required | 1 Check Digit | C11CK20 | 7-14 |
| | *2 Check Digits | C11CK21 | 7-14 |
| Code 11 Message Length | Minimum (1 - 80) *4 | C11MIN## | 7-14 |
| | Maximum (1 - 80) *80 | C11MAX## | 7-14 |
| Code 128 | Default All Code 128 Settings | 128DFT | 7-15 |
| | Off | 128ENA0 | 7-15 |
| | *On | 128ENA1 | 7-15 |
| ISBT Concatenation | *Off | ISBENA0 | 7-15 |
| | On | ISBENA1 | 7-15 |
| Code 128 Message Length | Minimum (0 - 80) *0 | 128MIN## | 7-15 |
| | Maximum (0 - 80) *80 | 128MAX## | 7-15 |
| Code 128 Append | *On | 128APP1 | 7-16 |
| | Off | 128APP0 | 7-16 |
| Code 128 Code Page | Code 128 Code Page (*2) | 128DCP## | 7-16 |
| GS1-128 | Default All GS1-128 Settings | GS1DFT | 7-17 |
| | *On | GS1ENA1 | 7-17 |
| | Off | GS1ENA0 | 7-17 |
| GS1-128 Message Length | Minimum (1 - 80) *1 | GS1MIN## | 7-17 |
| | Maximum (0 - 80) *80 | GS1MAX## | 7-17 |

| Selection | Setting <i>* Indicates default</i> | Serial Command <i># Indicates a numeric entry</i> | Page |
|--|--|---|----------------------|
| Telepen | Default All Telepen Settings | TELDFT | 7-18 |
| | *Off | TELENA0 | 7-18 |
| | On | TELENA1 | 7-18 |
| Telepen Output | *AIM Telepen Output | TELOLD0 | 7-18 |
| | Original Telepen Output | TELOLD1 | 7-18 |
| Telepen Message Length | Minimum (1 - 60) *1 | TELMIN## | 7-18 |
| | Maximum (1 - 60) *60 | TELMAX## | 7-18 |
| UPC-A | Default All UPC-A Settings | UPADFT | 7-19 |
| | Off | UPAENA0 | 7-19 |
| | *On | UPAENA1 | 7-19 |
| UPC-A Check Digit | Off | UPACKX0 | 7-19 |
| | *On | UPACKX1 | 7-19 |
| UPC-A Number System | Off | UPANSX0 | 7-19 |
| | *On | UPANSX1 | 7-19 |
| UPC-A 2 Digit Addenda | *Off | UPAAD20 | 7-20 |
| | On | UPAAD21 | 7-20 |
| UPC-A 5 Digit Addenda | *Off | UPAAD50 | 7-20 |
| | On | UPAAD51 | 7-20 |
| UPC-A Addenda Required | *Not Required | UPAARQ0 | 7-20 |
| | Required | UPAARQ1 | 7-20 |
| UPC-A Addenda Separator | Off | UPAADS0 | 7-20 |
| | *On | UPAADS1 | 7-20 |
| UPC-A/EAN-13 with Extended Coupon Code | *Off | CPNENA0 | 7-21 |
| | Allow Concatenation | CPNENA1 | 7-21 |
| | Require Concatenation | CPNENA2 | 7-21 |
| Coupon GS1 DataBar Output | GS1 Output Off | CPNGS10 | 7-21 |
| | GS1 Output On | CPNGS11 | 7-21 |
| UPC-E0 | Default All UPC-E Settings | UPEDFT | 7-22 |
| | Off | UPEEN00 | 7-22 |
| | *On | UPEEN01 | 7-22 |
| UPC-E0 Expand | *Off | UPEEXP0 | 7-22 |
| | On | UPEEXP1 | 7-22 |
| UPC-E0 Addenda Required | Required | UPEARQ1 | 7-22 |
| | *Not Required | UPEARQ0 | 7-22 |
| UPC-E0 Addenda Separator | *On | UPEADS1 | 7-23 |
| | Off | UPEADS0 | 7-23 |
| UPC-E0 Check Digit | Off | UPECKX0 | 7-23 |
| | *On | UPECKX1 | 7-23 |
| UPC-E0 Leading Zero | Off | UPENSX0 | 7-23 |
| | *On | UPENSX1 | 7-23 |

| Selection | Setting <i>* Indicates default</i> | Serial Command <i># Indicates a numeric entry</i> | Page |
|------------------------------|--|---|----------------------|
| UPC-E0 Addenda | 2 Digit Addenda On | UPEAD21 | 7-23 |
| | *2 Digit Addenda Off | UPEAD20 | 7-23 |
| | 5 Digit Addenda On | UPEAD51 | 7-23 |
| | *5 Digit Addenda Off | UPEAD50 | 7-23 |
| UPC-E1 | *Off | UPEEN10 | 7-24 |
| | On | UPEEN11 | 7-24 |
| EAN/JAN-13 | Default All EAN/ JAN Settings | E13DFT | 7-24 |
| | Off | E13ENA0 | 7-24 |
| | *On | E13ENA1 | 7-24 |
| Convert UPC-A to EAN-13 | UPC-A Converted to EAN-13 | UPAENA0 | 7-24 |
| | Do not Convert UPC-A | UPAENA1 | 7-24 |
| EAN/JAN-13 Check Digit | Off | E13CKX0 | 7-25 |
| | *On | E13CKX1 | 7-25 |
| EAN/JAN-13 2 Digit Addenda | 2 Digit Addenda On | E13AD21 | 7-25 |
| | *2 Digit Addenda Off | E13AD20 | 7-25 |
| | 5 Digit Addenda On | E13AD51 | 7-25 |
| | *5 Digit Addenda Off | E13AD50 | 7-25 |
| EAN/JAN-13 Addenda Required | *Not Required | E13ARQ0 | 7-25 |
| | Required | E13ARQ1 | 7-25 |
| EAN/JAN-13 Addenda Separator | Off | E13ADS0 | 7-26 |
| | *On | E13ADS1 | 7-26 |
| ISBN Translate | *Off | E13ISB0 | 7-26 |
| | On | E13ISB1 | 7-26 |
| EAN/JAN-8 | Default All EAN/ JAN 8 Settings | EA8DFT | 7-27 |
| | Off | EA8ENA0 | 7-27 |
| | *On | EA8ENA1 | 7-27 |
| EAN/JAN-8 Check Digit | Off | EA8CKX0 | 7-27 |
| | *On | EA8CKX1 | 7-27 |
| EAN/JAN-8 Addenda | *2 Digit Addenda Off | EA8AD20 | 7-27 |
| | 2 Digit Addenda On | EA8AD21 | 7-27 |
| | *5 Digit Addenda Off | EA8AD50 | 7-27 |
| | 5 Digit Addenda On | EA8AD51 | 7-27 |
| EAN/JAN-8 Addenda Required | *Not Required | EA8ARQ0 | 7-28 |
| | Required | EA8ARQ1 | 7-28 |
| EAN/JAN-8 Addenda Separator | Off | EA8ADS0 | 7-28 |
| | *On | EA8ADS1 | 7-28 |
| MSI | Default All MSI Settings | MSIDFT | 7-29 |
| | *Off | MSIENA0 | 7-29 |
| | On | MSIENA1 | 7-29 |

| Selection | Setting <i>* Indicates default</i> | Serial Command <i># Indicates a numeric entry</i> | Page |
|----------------------------------|--|---|----------------------|
| MSI Check Character | *Validate Type 10, but Don't Transmit | MSICLK0 | 7-29 |
| | Validate Type 10 and Transmit | MSICLK1 | 7-29 |
| | Validate 2 Type 10 Chars, but Don't Transmit | MSICLK2 | 7-29 |
| | Validate 2 Type 10 Chars and Transmit | MSICLK3 | 7-29 |
| | Validate Type 11 then Type 10 Char, but Don't Transmit | MSICLK4 | 7-29 |
| | Validate Type 11 then Type 10 Char and Transmit | MSICLK5 | 7-30 |
| | Disable MSI Check Characters | MSICLK6 | 7-30 |
| MSI Message Length | Minimum (4 - 48) *4 | MSIMIN## | 7-30 |
| | Maximum (4 - 48) *48 | MSIMAX## | 7-30 |
| GS1 DataBar Omnidirectional | Default All GS1 DataBar Omnidirectional Settings | RSSDFT | 7-31 |
| | Off | RSEENA0 | 7-31 |
| | *On | RSEENA1 | 7-31 |
| GS1 DataBar Limited | Default All GS1 DataBar Limited Settings | RSLDFT | 7-31 |
| | Off | RSEENA0 | 7-31 |
| | *On | RSEENA1 | 7-31 |
| GS1 DataBar Expanded | Default All GS1 DataBar Expanded Settings | RSEDFT | 7-32 |
| | Off | RSEENA0 | 7-32 |
| | *On | RSEENA1 | 7-32 |
| GS1 DataBar Expanded Msg. Length | Minimum (4 - 74) *4 | RSEMIN## | 7-32 |
| | Maximum (4 - 74) *74 | RSEMAX## | 7-32 |
| Trioptic Code | *Off | TRIENA0 | 7-32 |
| | On | TRIENA1 | 7-32 |
| Codablock A | Default All Codablock A Settings | CBADFT | 7-33 |
| | *Off | CBAENA0 | 7-33 |
| | On | CBAENA1 | 7-33 |
| Codablock A Msg. Length | Minimum (1 - 600) *1 | CBAMIN### | 7-33 |
| | Maximum (1 - 600) *600 | CBAMAX### | 7-33 |
| Codablock F | Default All Codablock F Settings | CBFDFT | 7-34 |
| | *Off | CBFENA0 | 7-34 |
| | On | CBFENA1 | 7-34 |
| Codablock F Msg. Length | Minimum (1 - 2048) *1 | CBFMIN#### | 7-34 |
| | Maximum (1 - 2048) *2048 | CBFMAX#### | 7-34 |
| PDF417 | Default All PDF417 Settings | PDFDFT | 7-35 |
| | *On | PDFENA1 | 7-35 |
| | Off | PDFENA0 | 7-35 |

| Selection | Setting <i>* Indicates default</i> | Serial Command <i># Indicates a numeric entry</i> | Page |
|---------------------------------|--|---|-------------|
| PDF417 Msg. Length | Minimum (1-2750) *1 | PDFMIN#### | 7-35 |
| | Maximum (1-2750) *2750 | PDFMAX#### | 7-35 |
| MacroPDF417 | *On | PDFMAC1 | 7-36 |
| | Off | PDFMAC0 | 7-36 |
| MicroPDF417 | Default All Micro PDF417 Settings | MPDDFT | 7-36 |
| | On | MPDENA1 | 7-36 |
| | *Off | MPDENA0 | 7-36 |
| MicroPDF417 Msg. Length | Minimum (1-366) *1 | MPDMIN### | 7-36 |
| | Maximum (1-366) *366 | MPDMAX### | 7-36 |
| GS1 Composite Codes | On | COMENA1 | 7-36 |
| | *Off | COMENA0 | 7-36 |
| UPC/EAN Version | On | COMUPC1 | 7-37 |
| | *Off | COMUPC0 | 7-37 |
| GS1 Composite Codes Msg. Length | Minimum (1-2435) *1 | COMMIN#### | 7-37 |
| | Maximum (1-2435) *2435 | COMMAX#### | 7-37 |
| GS1 Emulation | GS1-128 Emulation | EANEMU1 | 7-37 |
| | GS1 DataBar Emulation | EANEMU2 | 7-36 |
| | GS1 Code Expansion Off | EANEMU3 | 7-38 |
| | EAN8 to EAN13 Conversion | EANEMU4 | 7-38 |
| | *GS1 Emulation Off | EANEMU0 | 7-38 |
| TCIF Linked Code 39 | On | T39ENA1 | 7-38 |
| | *Off | T39ENA0 | 7-38 |
| QR Code | Default All QR Code Settings | QRCDFT | 7-38 |
| | *On | QRCENA1 | 7-38 |
| | Off | QRCENA0 | 7-38 |
| QR Code Msg. Length | Minimum (1-7089) *1 | QRCMIN#### | 7-39 |
| | Maximum (1-7089) *7089 | QRCMAX#### | 7-39 |
| QR Code Append | *On | QRCAPP1 | 7-39 |
| | Off | QRCAPP0 | 7-39 |
| QR Code Page | QR Code Page (*3) | QRCDCP## | 7-39 |
| Data Matrix | Default All Data Matrix Settings | IDMDFT | 7-40 |
| | *On | IDMENA1 | 7-40 |
| | Off | IDMENA0 | 7-40 |
| Data Matrix Msg. Length | Minimum (1-3116) *1 | IDMMIN#### | 7-40 |
| | Maximum (1-3116) *3116 | IDMMAX#### | 7-40 |
| Data Matrix Append | *On | IDMAPP1 | 7-40 |
| | Off | IDMAPP0 | 7-40 |
| Data Matrix Code Page | Data Matrix Code Page (*51) | IDMDCP## | 7-40 |
| MaxiCode | Default All MaxiCode Settings | MAXDFT | 7-41 |
| | On | MAXENA1 | 7-41 |
| | *Off | MAXENA0 | 7-41 |
| MaxiCode Msg. Length | Minimum (1-150) *1 | MAXMIN### | 7-41 |
| | Maximum (1-150) *150 | MAXMAX### | 7-41 |

| Selection | Setting <i>* Indicates default</i> | Serial Command <i># Indicates a numeric entry</i> | Page |
|--|--|---|----------------------|
| Aztec Code | Default All Aztec Code Settings | AZTDFT | 7-42 |
| | *On | AZTENA1 | 7-42 |
| | Off | AZTENA0 | 7-42 |
| Aztec Code Msg. Length | Minimum (1-3832) *1 | AZTMIN#### | 7-42 |
| | Maximum (1-3832) *3832 | AZTMAX#### | 7-42 |
| Aztec Append | *On | AZTAPP1 | 7-42 |
| | Off | AZTAPP0 | 7-42 |
| Aztec Code Page | Aztec Code Page (*51) | AZTDCP## | 7-42 |
| Chinese Sensible (Han Xin) Code | Default All Han Xin Code Settings | HX_DFT | 7-43 |
| | On | HX_ENA1 | 7-43 |
| | *Off | HX_ENA0 | 7-43 |
| Chinese Sensible (Han Xin) Code Msg. Length | Minimum (1-7833) *1 | HX_MIN#### | 7-43 |
| | Maximum (1-7833) *7833 | HX_MAX#### | 7-43 |
| Postal Codes - 2D | | | |
| 2D Postal Codes | *Off | POSTAL0 | 7-44 |
| Single 2D Postal Codes | Australian Post On | POSTAL1 | 7-44 |
| | British Post On | POSTAL7 | 7-44 |
| | Canadian Post On | POSTAL30 | 7-44 |
| | Intelligent Mail Bar Code On | POSTAL10 | 7-44 |
| | Japanese Post On | POSTAL3 | 7-44 |
| | KIX Post On | POSTAL4 | 7-44 |
| | Planet Code On | POSTAL5 | 7-44 |
| | Postal-4i On | POSTAL9 | 7-44 |
| | Postnet On | POSTAL6 | 7-45 |
| | Postnet with B and B' Fields On | POSTAL11 | 7-45 |
| InfoMail On | POSTAL2 | 7-45 | |

| Selection | Setting <i>* Indicates default</i> | Serial Command <i># Indicates a numeric entry</i> | Page |
|---|---|---|----------------------|
| Combination 2D Postal Codes | InfoMail and British Post On | POSTAL8 | 7-45 |
| | Intelligent Mail Bar Code and Postnet with B and B' Fields On | POSTAL20 | 7-45 |
| | Postnet and Postal-4i On | POSTAL14 | 7-45 |
| | Postnet and Intelligent Mail Bar Code On | POSTAL16 | 7-45 |
| | Postal-4i and Intelligent Mail Bar Code On | POSTAL17 | 7-45 |
| | Postal-4i and Postnet with B and B' Fields On | POSTAL19 | 7-45 |
| | Planet and Postnet On | POSTAL12 | 7-45 |
| | Planet and Postnet with B and B' Fields On | POSTAL18 | 7-46 |
| | Planet and Postal-4i On | POSTAL13 | 7-46 |
| | Planet and Intelligent Mail Bar Code On | POSTAL15 | 7-46 |
| | Planet, Postnet, and Postal-4i On | POSTAL21 | 7-46 |
| | Planet, Postnet, and Intelligent Mail Bar Code On | POSTAL22 | 7-46 |
| | Planet, Postal-4i, and Intelligent Mail Bar Code On | POSTAL23 | 7-46 |
| | Combination 2D Postal Codes (continued) | Postnet, Postal-4i, and Intelligent Mail Bar Code On | POSTAL24 |
| Planet, Postal-4i, and Postnet with B and B' Fields On | | POSTAL25 | 7-46 |
| Planet, Intelligent Mail Bar Code, and Postnet with B and B' Fields On | | POSTAL26 | 7-46 |
| Postal-4i, Intelligent Mail Bar Code, and Postnet with B and B' Fields On | | POSTAL27 | 7-46 |
| Planet, Postal-4i, Intelligent Mail Bar Code, and Postnet On | | POSTAL28 | 7-47 |
| Planet, Postal-4i, Intelligent Mail Bar Code, and Postnet with B and B' Fields On | | POSTAL29 | 7-46 |
| Planet Code Check Digit | Transmit | PLNCKX1 | 7-47 |
| | *Don't Transmit | PLNCKX0 | 7-47 |
| Postnet Check Digit | Transmit | NETCKX1 | 7-47 |
| | *Don't Transmit | NETCKX0 | 7-47 |
| Australian Post Interpretation | Bar Output | AUSINT0 | 7-48 |
| | Numeric N Table | AUSINT1 | 7-48 |
| | Alphanumeric C Table | AUSINT2 | 7-48 |
| | Combination N and C Tables | AUSINT3 | 7-48 |

| Selection | Setting <i>* Indicates default</i> | Serial Command <i># Indicates a numeric entry</i> | Page |
|---|--|--|------|
| Postal Codes - Linear | | | |
| China Post (Hong Kong 2 of 5) | Default All China Post (Hong Kong 2 of 5) Settings | CPCDFT | 7-48 |
| | *Off | CPCENA0 | 7-48 |
| | On | CPCENA1 | 7-48 |
| China Post (Hong Kong 2 of 5) Msg. Length | Minimum (2 - 80) *4 | CPCMIN## | 7-48 |
| | Maximum (2 - 80) *80 | CPCMAX## | 7-48 |
| Korea Post | Default All Korea Post Settings | KPCDFT | 7-49 |
| | *Off | KPCENA0 | 7-49 |
| | On | KPCENA1 | 7-49 |
| Korea Post Msg. Length | Minimum (2 - 80) *4 | KPCMIN## | 7-49 |
| | Maximum (2 - 80) *48 | KPCMAX## | 7-49 |
| Korea Post Check Digit | Transmit Check Digit | KPCCHK1 | 7-49 |
| | *Don't Transmit Check Digit | KPCCHK0 | 7-49 |
| Imaging Default Commands | | | |
| Image Snap | Default all Imaging Commands | IMGDFT | 8-1 |
| | Imaging Style - Decoding | SNPSTY0 | 8-1 |
| | *Imaging Style - Photo | SNPSTY1 | 8-1 |
| | Imaging Style - Manual | SNPSTY2 | 8-1 |
| | Beeper On | SNPBEP1 | 8-1 |
| | *Beeper Off | SNPBEP0 | 8-1 |
| | *Wait for Trigger Off | SNPTRG0 | 8-2 |
| | Wait for Trigger On | SNPTRG1 | 8-2 |
| | *LED State - Off | SNPLED0 | 8-2 |
| | LED State - On | SNPLED1 | 8-2 |
| | Exposure (1-7874 microseconds) | SNPEXP | 8-2 |
| | *Gain - None | SNPGAN1 | 8-2 |
| | Gain - Medium | SNPGAN2 | 8-2 |
| | Gain - Heavy | SNPGAN4 | 8-2 |
| | Gain - Maximum | SNPGAN8 | 8-2 |
| | Target White Value (0-255) *125 | SNPWHT### | 8-3 |
| | Delta for Acceptance (0-255) *25 | SNPDEL### | 8-3 |
| | Update Tries (0-10) *6 | SNPTRY## | 8-3 |
| Target Set Point Percentage (1-99) *50 | SNPPCT## | 8-3 | |

| Selection | Setting <i>* Indicates default</i> | Serial Command <i># Indicates a numeric entry</i> | Page |
|------------------------|---|---|-------------|
| Image Ship | *Infinity Filter - Off | IMGINF0 | 8-4 |
| | Infinity Filter - On | IMGINF1 | 8-4 |
| | *Compensation Off | IMGCOR0 | 8-4 |
| | Compensation On | IMGCOR1 | 8-4 |
| | *Pixel Depth - 8 bits/pixel (grayscale) | IMGBPP8 | 8-4 |
| | Pixel Depth - 1 bit/pixel (B&W) | IMGBPP1 | 8-4 |
| | *Don't Sharpen Edges | IMGEDG0 | 8-5 |
| | Sharpen Edges (0-23) | IMGEDG## | 8-5 |
| | *File Format - JPEG | IMGFMT6 | 8-5 |
| | File Format - KIM | IMGFMT0 | 8-5 |
| | File Format - TIFF binary | IMGFMT1 | 8-5 |
| | File Format - TIFF binary group 4, compressed | IMGFMT2 | 8-5 |
| | File Format - TIFF grayscale | IMGFMT3 | 8-5 |
| | File Format - Uncompressed binary | IMGFMT4 | 8-5 |
| | File Format - Uncompressed grayscale | IMGFMT5 | 8-5 |
| | File Format - BMP | IMGFMT8 | 8-5 |
| | *Histogram Stretch Off | IMGHIS0 | 8-5 |
| | Histogram Stretch On | IMGHIS1 | 8-5 |
| | *Noise Reduction Off | IMGFSP0 | 8-6 |
| | Noise Reduction On | IMGFSP1 | 8-6 |
| Image Ship (continued) | Invert Image around X axis | IMGNVX1 | 8-6 |
| | Invert Image around Y axis | IMGNVY1 | 8-6 |
| | Rotate Image none | IMGROT0 | 8-7 |
| | Rotate Image 90° right | IMGROT1 | 8-7 |
| | Rotate Image 180° right | IMGROT2 | 8-7 |
| | Rotate Image 90° left | IMGROT3 | 8-7 |
| | JPEG Image Quality (0-100) *50 | IMGJQF### | 8-7 |
| | *Gamma Correction Off | IMGGAM0 | 8-7 |
| | Gamma Correction On (0-1000) | IMGGAM### | 8-7 |
| | Image Crop - Left (0-843) *0 | IMGWNL### | 8-8 |
| | Image Crop - Right (0-843) *843 | IMGWNR### | 8-8 |
| | Image Crop - Top (0-639) *0 | IMGWNT### | 8-8 |
| | Image Crop - Bottom (0-639) *639 | IMGWNB### | 8-8 |
| | Image Crop - Margin (1-238) *0 | IMGMAR### | 8-8 |
| | Protocol - None (raw) | IMGXFR0 | 8-8 |
| | Protocol - None (default USB) | IMGXFR2 | 8-8 |
| | Protocol - Hmodem Compressed | IMGXFR3 | 8-8 |
| | Protocol - Hmodem | IMGXFR4 | 8-8 |
| | Ship Every Pixel | IMGSUB1 | 8-8 |

| Selection | Setting <i>* Indicates default</i> | Serial Command <i># Indicates a numeric entry</i> | Page |
|---|--|---|-------------|
| Image Ship (continued) | Ship Every 2nd Pixel | IMGSUB2 | 8-8 |
| | Ship Every 3rd Pixel | IMGSUB3 | 8-9 |
| | *Document Image Filter Off | IMGUSH0 | 8-9 |
| | Document Image Filter On (0-255) | IMGUSH### | 8-9 |
| | *Don't Ship Histogram | IMGHST0 | 8-9 |
| | Ship Histogram | IMGHST1 | 8-9 |
| Image Size Compatibility | Force VGA Resolution | IMGVGA1 | 8-10 |
| | *Native Resolution | IMGVGA0 | 8-10 |
| Intelligent Signature Capture | Optimize On | DECBND1 | 8-10 |
| | *Optimize Off | DECBND0 | 8-10 |
| Utilities | | | |
| Add Code I.D. Prefix to All Symbologies (Temporary) | | PRECA2,BK2995C80! | 10-1 |
| Show Decoder Revision | | REV_DR | 10-1 |
| Show Scan Driver Revision | | REV_SD | 10-1 |
| Show Software Revision | | REVINF | 10-1 |
| Show Data Format | | DFMBK3? | 10-1 |
| Test Menu | On | TSTMNU1 | 10-2 |
| | *Off | TSTMNU0 | 10-2 |
| Application Plug-Ins (Apps) | *Decoding Apps On | PLGDCE1 | 10-2 |
| | Decoding Apps Off | PLGDCE0 | 10-2 |
| | *Formatting Apps On | PLGFOE1 | 10-2 |
| | Formatting Apps Off | PLGFOE0 | 10-2 |
| | List Apps | PLGINF | 10-2 |
| Resetting the Factory Defaults | Remove Custom Defaults | DEFOVR | 10-4 |
| | Activate Defaults | DEFALT | 10-4 |

Product Specifications

Xenon 1900/1910 Corded Scanner Product Specifications

| Parameter | Specification |
|--------------------------------|--|
| Dimensions (Typical): | |
| Height | 6.3 inches (16cm) |
| Length | 4.1 inches (10.41cm) |
| Width | 2.8 inches (7.11cm) |
| Weight | 5.2 ounces (147.42g) |
| Illumination LED: | |
| Peak Wavelength | 624nm \pm 18nm (red LED) IEC 62471: "Exempt Risk Group" 442nm, 552nm (white LED) IEC 62471: "Exempt Risk Group" |
| Aiming: | |
| Peak Wavelength Laser | 650nm IEC 60825-1: "Class 2" |
| Peak Wavelength LED | 624nm \pm 18nm IEC 62471: "Exempt Risk Group" |
| Optical Power Laser | <1mW |
| Image Size | 838 x 640 pixels |
| Skew Angle | $\pm 65^\circ$ |
| Pitch Angle | $\pm 45^\circ$ |
| Motion Tolerance: | |
| Streaming Presentation Trigger | up to 240 inches per second for 13 mil UPC |
| Symbol Contrast | Grade 1.0 (20% or greater) |
| Voltage Requirements | 4 - 5.5 VDC at input connector |
| Current Draw @5VDC | |
| B&W | <u>Scanning</u> 470mA, 2.35W <u>Standby</u> 90mA, .45W |
| Color | 490mA, 2.45W 90mA, .45W |
| Power Supply Noise Rejection | Maximum 100mV peak to peak, 10 to 100 kHz |
| Temperature Ranges: | |
| Operating | +32°F to +122°F (0°C to 50°C) |
| Storage | -40°F to +158°F (-40°C to 70°C) |
| Humidity | 0 to 95% non-condensing |
| Mechanical Drop | Operational after 50 drops from 6 feet (1.83m) to concrete at 23°C |
| Vibration | Withstands 5G peak from 22 to 300 Hz |
| ESD Tolerance | Up to 15kV direct air Up to 8 kV indirect coupling plane |

Xenon 1902/1912 Cordless Scanner Product Specifications

| Parameter | Specification |
|-----------------------|----------------------|
| Dimensions (Typical): | |
| Height | 6.3 inches (160cm) |
| Length | 4.1 inches (10.41cm) |
| Width | 2.8 inches (7.11cm) |
| Weight | 7.5 ounces (212.62g) |

| (Continued)Parameter | Specification |
|---|--|
| Illumination LED: Peak Wavelength | 624nm \pm 18nm (red LED) IEC 62471: "Exempt Risk Group" 442nm, 552nm (white LED) IEC 62471: "Exempt Risk Group" |
| Aiming: Peak Wavelength Laser Peak Wavelength LED Optical Power Laser | 650nm IEC 60825-1: "Class 2" 624nm \pm 18nm IEC 62471: "Exempt Risk Group" <1mW |
| Image Size | 838 x 640 pixels |
| Skew Angle | $\pm 65^\circ$ |
| Pitch Angle | $\pm 45^\circ$ |
| Motion Tolerance: Streaming Presentation Trigger | up to 240 inches per second for 13 mil UPC |
| Symbol Contrast | Grade 1.0 (20% or greater) |
| Battery: Lithium Ion Number of Scans Expected Hours of Operation Expected Charge Time | 1800 mAHr minimum Up to 50,000 per charge 14 4.5 hours |
| Radio: Frequency Range Data Rate | 2.4 to 2.5 GHz (ISM Band) Frequency Hopping Bluetooth v.2.1 33 ft. (10 m) typical Up to 1 MBps |
| Temperature Ranges: Operating Storage* | 32° F to +122° F (0° C to 50° C) -40° F to +158° F (-40° C to 70° C) |
| Humidity | Up to 95% non-condensing |
| Mechanical Drop | Operational after 50 drops from 6 feet (1.8 m) to concrete |
| Vibration | Withstands 5G peak from 22 to 300 Hz |
| ESD Sensitivity | Up to 15kV direct air Up to 8 kV indirect coupling plane |
| Sealant Rating | IP41 |

*Storage outside of this temperature range could be detrimental to battery life.

Granit 1910i Industrial Corded Scanner Product Specifications

| Parameter | Specification |
|--|--|
| Dimensions (Typical): Height Length Width Weight | 7.7 in. (19.45cm) 5.2 in. (13.31cm) 2.9 in. (7.5cm) 10.6 oz. (300g) |
| Illumination LED: Peak Wavelength | 656nm (hyper red LED) IEC 62471: "Exempt Risk Group" |

| (Continued)Parameter | Specification |
|--|--|
| Aiming: Peak Wavelength Laser | 650nm IEC 60825-1: "Class 2" |
| Optical Power Laser | <1mW |
| Image Size | 838 x 640 pixels |
| Skew Angle | ±65° |
| Pitch Angle | ±45° |
| Motion Tolerance: Streaming Presentation Trigger: 13 mil UPC | 240 inches per second at 6.5 in. (16.5cm) 150 inches per second at 10 in. (25.4cm) |
| Symbol Contrast | Grade 1.0 (20% or greater) |
| Voltage Requirements | 4 - 5.5 VDC at input connector |
| Current Draw @5VDC | Scanning Standby 470mA, 2.35W 100mA, .5W |
| Power Supply Noise Rejection | Maximum 100mV peak to peak, 10 to 100 kHz |
| Temperature Ranges: Operating | -22°F to +122°F (-30°C to 50°C) |
| Storage | -40°F to +158°F (-40°C to 70°C) |
| Humidity | 0 to 95% non-condensing |
| Mechanical Drop | Operational after 50 drops from 6.5 feet (1.98m) to concrete at 23°, -30°, and 50°C |
| Vibration | Complies with MIL-STD-810G, Method 514.6, Annex C |
| ESD Tolerance | Up to 20kV direct air Up to 8 kV indirect coupling plane |
| Sealant Rating | IP65 |

Granit 1911i Industrial Cordless Scanner Product Specifications

| Parameter | Specification |
|--|---|
| Dimensions (Typical): Height | 7.7 in. (19.45cm) |
| Length | 5.2 in. (13.31cm) |
| Width | 2.9 in. (7.5cm) |
| Weight | 13.8 oz. (390g) |
| Illumination LED: Peak Wavelength | 656nm (hyper red LED) IEC 62471: "Exempt Risk Group" |
| Aiming: Peak Wavelength Laser | 650nm IEC 60825-1: "Class 2" |
| Optical Power Laser | <1mW |
| Image Size | 838 x 640 pixels |
| Skew Angle | ±65° |
| Pitch Angle | ±45° |
| Motion Tolerance: Streaming Presentation Trigger: 13 mil UPC | 240 inches per second at 6.5 in. (16.5cm) 150 inches per second at 10 in. (25.4cm) |
| Symbol Contrast | Grade 1.0 (20% or greater) |
| Battery: | |

| (Continued)Parameter | Specification |
|------------------------------|---|
| Lithium Ion | 1800 mAh minimum |
| Number of Scans | Up to 50,000 per charge |
| Expected Hours of Operation | 14 |
| Expected Charge Time | 4.5 hours |
| Radio: | |
| Frequency | 2.4 to 2.5 GHz (ISM Band) Frequency Hopping Bluetooth v.2.1 |
| Range | 330 ft. (100m) typical |
| Data Rate | Up to 1 Mbps |
| Temperature Ranges: | |
| Operating while not charging | -4°F to + 122°F (-20°C to 50°C) |
| Operating while charging | 41°F to + 104°F (5°C to 40°C) |
| Storage* | -40°F to +158°F (-40°C to 70°C) |
| Humidity | Up to 95% non-condensing |
| Mechanical Drop | Operational after 50 drops from 6.5 feet (1.98m) to concrete at 23°, -30°, and 50°C |
| Vibration | Complies with MIL-STD-810G, Method 514.6, Annex C |
| ESD Sensitivity | Up to 20kV direct air Up to 8 kV indirect coupling plane |
| Sealant Rating | IP65 |

*Storage outside of this temperature range could be detrimental to battery life.

CCB01-010BT Charge Base Product Specifications

| Parameter | Specification |
|-----------------------|---|
| Dimensions (Typical): | |
| Height | 3.2 inches (8.13cm) |
| Length | 5.19 inches (13.18cm) |
| Width | 3.98 inches (10.11cm) |
| Weight | 6.3 oz (179g) |
| Voltage: | 4.5 to 5.5 volts |
| Current Draw: | |
| Host Terminal Port | 500mA |
| Aux Power Port | 1A |
| Charge Time | 5 hours |
| Radio: | |
| Frequency | 2.4 to 2.5 GHz (ISM Band) Frequency Hopping Bluetooth v.2.1 |
| Range | 33 ft. (10 m) typical |
| Data Rate | Up to 1 Mbps |
| Temperature Ranges: | |
| Operating | 32° F to +122° F (0° C to +50° C) |
| Battery Charge | 41° F to +104° F (5° C to +40° C) |
| Storage | -40° F to +158° F (-40° C to +70° C) |
| Humidity | Up to 95% non-condensing |
| Mechanical Drop | Operational after 50 drops from 3.28 feet (1 m) to concrete |
| Vibration | 5G Peak from 22Hz to 300Hz |
| ESD Sensitivity | Up to 15kV direct air Up to 8 kV indirect coupling plane |

CCB02-100BT Industrial Charge Base Product Specifications

| Parameter | Specification |
|---|--|
| Dimensions (Typical): Height Length Width Weight | 2.6 in. (6.6cm) 9.8 in. (24.98mm) 4.05 in. (10.28cm) 10.05 oz. (285g) |
| Voltage: | 4.5 to 5.5 volts |
| Current Draw: Host Terminal Port Aux Power Port | 500mA 1A |
| Charge Time | 5 hours |
| Radio: Frequency Range Data Rate | 2.4 to 2.5 GHz (ISM Band) Frequency Hopping Bluetooth v.2.1 330 ft. (100m) typical Up to 1 MBps |
| Temperature Ranges: Operating Battery Charge Storage | -4° F to +122° F (-20° C to +50° C) 41° F to +104° F (5° C to +40° C) -40° F to +158° F (-40° C to +70° C) |
| Humidity | Up to 95% non-condensing |
| Mechanical Drop | Operational after 50 drops from 3.94 feet (1.2m) to concrete |
| Vibration | Complies with MIL-STD-810G, Method 514.6, Annex C |
| ESD Sensitivity | Up to 20kV direct air Up to 8 kV indirect coupling plane |

Depth of Field Charts

Xenon B&W Scanner Typical Performance

| Focus | | High Density (HD) | | Standard Range (SR) | | Extended Range (ER) | |
|-----------------------------|-----|-------------------|--------------|---------------------|--------------|---------------------|--------------|
| Symbology | | Near Distance | Far Distance | Near Distance | Far Distance | Near Distance | Far Distance |
| 5 mil Code 39 | in. | .2 | 3.8 | 1.6 | 5.3 | 3.7 | 8 |
| | mm | 5.1 | 96.5 | 40.6 | 134.6 | 94 | 203.2 |
| 13 mil UPC | in. | .5 | 6.5 | .3 | 16.7 | 1 | 20.7 |
| | mm | 12.7 | 165.1 | 7.6 | 424.2 | 25.4 | 525.8 |
| 20 mil Code 39 | in. | .6 | 8.6 | .4 | 24.6 | 1 | 23.5 |
| | mm | 15.2 | 218.4 | 10.2 | 624.8 | 25.4 | 596.9 |
| 6.7 mil PDF417 | in. | .4 | 4 | .7 | 6 | 2.8 | 9.2 |
| | mm | 10.2 | 101.6 | 17.8 | 152.4 | 71.1 | 233.7 |
| 10 mil Data Matrix | in. | .3 | 4.2 | .8 | 7 | 2.5 | 11.3 |
| | mm | 7.6 | 106.7 | 20.3 | 177.8 | 63.5 | 287 |
| 20 mil QR Code | in. | .7 | 7 | .5 | 14.8 | .7 | 19 |
| | mm | 17.8 | 177.8 | 12.7 | 375.9 | 17.8 | 482.6 |
| Resolution (1D Code 39) | | 3 mil (.076mm) | | 5 mil (.127mm) | | 5 mil (.127mm) | |
| Resolution (2D Data Matrix) | | 5 mil (.127mm) | | 6.7 mil (.170mm) | | 7.5 mil (.191mm) | |

Xenon B&W Scanner Guaranteed Performance

| Focus | | High Density (HD) | | Standard Range (SR) | | Extended Range (ER) | |
|-----------------------------|-----|-------------------|--------------|---------------------|--------------|---------------------|--------------|
| Symbology | | Near Distance | Far Distance | Near Distance | Far Distance | Near Distance | Far Distance |
| 5 mil Code 39 | in. | .3 | 3.3 | 2.1 | 5.1 | 4.2 | 7.8 |
| | mm | 7.62 | 83.8 | 53.3 | 129.5 | 106.7 | 198.1 |
| 13 mil UPC | in. | .7 | 6.1 | .4 | 15.6 | 1.1 | 19.7 |
| | mm | 17.8 | 154.9 | 10.2 | 396.2 | 27.9 | 500.4 |
| 20 mil Code 39 | in. | .7 | 7.8 | .5 | 20.2 | 1.5 | 25 |
| | mm | 17.8 | 198.1 | 12.7 | 513.1 | 38.1 | 635 |
| 6.7 mil PDF417 | in. | .5 | 3.8 | .9 | 5.8 | 3.3 | 8.7 |
| | mm | 12.7 | 96.5 | 22.9 | 147.3 | 83.8 | 221 |
| 10 mil Data Matrix | in. | .4 | 3.8 | .9 | 6.6 | 3.4 | 10.3 |
| | mm | 10.2 | 96.5 | 22.9 | 167.6 | 86.4 | 261.6 |
| 20 mil QR Code | in. | 1.2 | 6.4 | .7 | 13 | .9 | 18 |
| | mm | 30.5 | 162.6 | 17.8 | 330.2 | 22.9 | 457.2 |
| Resolution (1D Code 39) | | 3 mil (.076mm) | | 5 mil (.127mm) | | 5 mil (.127mm) | |
| Resolution (2D Data Matrix) | | 5 mil (.127mm) | | 6.7 mil (.170mm) | | 7.5 mil (.191mm) | |

Xenon Color Scanner (Model COL) Typical Performance

| Focus | | High Density (HD) | | Standard Range (SR) | |
|-----------------------------|-----|-------------------|--------------|---------------------|--------------|
| Symbology | | Near Distance | Far Distance | Near Distance | Far Distance |
| 5 mil Code 39 | in. | 0 | 3.6 | 1.1 | 5.2 |
| | mm | 0 | 91.4 | 27.9 | 132.1 |
| 13 mil UPC | in. | .4 | 5.9 | .4 | 16.2 |
| | mm | 10.2 | 149.9 | 10.2 | 411.5 |
| 20 mil Code 39 | in. | .4 | 8.4 | .5 | 22 |
| | mm | 10.2 | 213.4 | 12.7 | 558.8 |
| 6.7 mil PDF417 | in. | 0 | 3.8 | .4 | 6 |
| | mm | 0 | 96.5 | 10.2 | 152.4 |
| 10 mil Data Matrix | in. | 0 | 4.2 | .5 | 7 |
| | mm | 0 | 106.7 | 12.7 | 177.8 |
| 20 mil QR Code | in. | .4 | 6.8 | .6 | 13.4 |
| | mm | 10.2 | 172.7 | 15.2 | 340.4 |
| Resolution (1D Code 39) | | 3 mil (.076mm) | | 5 mil (.127mm) | |
| Resolution (2D Data Matrix) | | 5 mil (.127mm) | | 6.7 mil (.170mm) | |

Xenon Color Scanner (Model COL) Guaranteed Performance

| Focus | | High Density (HD) | | Standard Range (SR) | |
|-----------------------------|-----|-------------------|--------------|---------------------|--------------|
| Symbology | | Near Distance | Far Distance | Near Distance | Far Distance |
| 5 mil Code 39 | in. | 0 | 3.3 | 1.7 | 4.9 |
| | mm | 0 | 83.8 | 43.2 | 124.5 |
| 13 mil UPC | in. | .6 | 5.2 | .4 | 14.5 |
| | mm | 15.2 | 132.1 | 10.2 | 368.3 |
| 20 mil Code 39 | in. | .5 | 7.4 | .5 | 17.5 |
| | mm | 12.7 | 188 | 12.7 | 444.5 |
| 6.7 mil PDF417 | in. | 0 | 3.4 | .5 | 5.7 |
| | mm | 0 | 86.4 | 12.7 | 144.8 |
| 10 mil Data Matrix | in. | 0 | 4 | .8 | 6.4 |
| | mm | 0 | 101.6 | 20.3 | 162.6 |
| 20 mil QR Code | in. | .7 | 6.2 | .7 | 12.3 |
| | mm | 17.8 | 157.5 | 17.8 | 312.4 |
| Resolution (1D Code 39) | | 3 mil (.076mm) | | 5 mil (.127mm) | |
| Resolution (2D Data Matrix) | | 5 mil (.127mm) | | 6.7 mil (.170mm) | |

Granit Scanner Typical Performance

| Focus | | Extended Range (ER) | |
|----------------|-----|---------------------|--------------|
| Symbology | | Near Distance | Far Distance |
| 5 mil Code 39 | in. | 3.6 | 7.4 |
| | mm | 91.4 | 188 |
| 20 mil Code 39 | in. | .6 | 29.5 |
| | mm | 15.2 | 749.3 |

| Focus | | Extended Range (ER) | |
|-----------------------------|-----|---------------------|-------|
| 100% UPC | in. | .6 | 21.4 |
| | mm | 15.2 | 543.6 |
| 6.7 mil PDF417 | in. | 2.7 | 8.9 |
| | mm | 68.6 | 226.1 |
| 10 mil Data Matrix | in. | 2.8 | 10.3 |
| | mm | 71.1 | 261.6 |
| 20 mil QR Code | in. | .8 | 19.5 |
| | mm | 20.3 | 495.3 |
| Resolution (1D Code 39) | | 5 mil (.127mm) | |
| Resolution (2D Data Matrix) | | 7.5 mil (.191mm) | |

Granit Scanner Guaranteed Performance

| Focus | | Extended Range (ER) | |
|-----------------------------|-----|---------------------|--------------|
| Symbology | | Near Distance | Far Distance |
| 5 mil Code 39 | in. | 3.8 | 7.2 |
| | mm | 96.5 | 182.9 |
| 20 mil Code 39 | in. | 1 | 28.7 |
| | mm | 25.4 | 729 |
| 100% UPC | in. | .6 | 21.7 |
| | mm | 15.2 | 551.2 |
| 6.7 mil PDF417 | in. | 3 | 8.5 |
| | mm | 76.2 | 215.9 |
| 10 mil Data Matrix | in. | 3.1 | 9.7 |
| | mm | 78.7 | 246.4 |
| 20 mil QR Code | in. | .9 | 19.8 |
| | mm | 22.9 | 502.9 |
| Resolution (1D Code 39) | | 5 mil (.127mm) | |
| Resolution (2D Data Matrix) | | 7.5 mil (.191mm) | |

Standard Connector Pinouts

Note: The following pin assignments are not compatible with Honeywell legacy products. Use of a cable with improper pin assignments may lead to damage to the unit. Use of any cables not provided by the manufacturer may result in damage not covered by your warranty.

Keyboard Wedge

10 Pin RJ41 Modular Plug - connects to the base

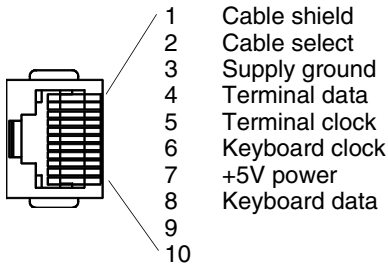

Serial Output

10 Pin RJ41 Modular Plug - connects to the base

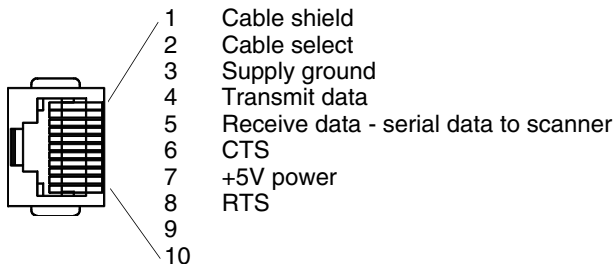

RS485 Output

10 Pin RJ41 Modular Plug - connects to the base

Note: RS485 signal conversion is performed in the cable.

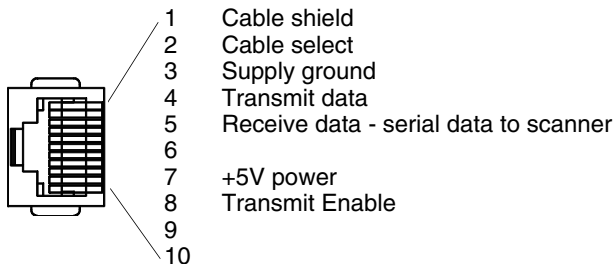

USB

10 Pin Modular Plug - connects to the base

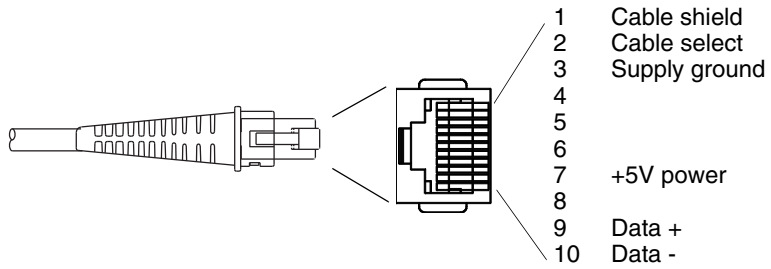

Repairs

Repairs and/or upgrades are not to be performed on this product. These services are to be performed only by an authorized service center (see [Customer Support](#) on page 14-1).

Maintenance

Your device provides reliable and efficient operation with a minimum of care. Although specific maintenance is not required, the following periodic checks ensure dependable operation:

Cleaning the Scanner

The scanner or base's housing may be cleaned with a soft cloth or tissue dampened with water (or a mild detergent-water solution.) If a detergent solution is used, rinse with a clean tissue dampened with water only.



Caution:

Do not submerge the scanner in water. The scanner's housing is not watertight.

Do not use abrasive wipes or tissues on the scanner's window – abrasive wipes may scratch the window. Never use solvents (e.g., acetone) on the housing or window – solvents may damage the finish or the window.

Cleaning the Window

Reading performance may degrade if the scanner's window is not clean. If the window is visibly dirty, or if the scanner isn't operating well, clean the window with one of the cleaning solutions listed for [Health Care Housing](#), below.

Health Care Housing

Some configurations of Xenon scanners are available with an external plastic housing that is designed to resist the effects of harsh chemicals in a health care environment. The plastic is crystalline in nature, which helps prevent chemicals from seeping through the housing.

Important! The following cleaning solutions have been tested to assure safe cleaning of your scanner's disinfectant-ready housing. They are the only solutions approved for use with these scanners. Damage caused by the use of cleaners other than those listed below may not be covered by the warranty.

- Sani-Cloth® HB wipes
- Sani-Cloth® Plus wipes
- Super Sani-Cloth® wipes
- Isopropyl Alcohol wipes (70%)
- CaviWipes™
- Virex® 256
- 409® Glass and Surface Cleaner
- Windex® Blue
- Clorox® Bleach – 10%
- Gentle dish soap and water

Inspecting Cords and Connectors

Inspect the interface cable and connector for wear or other signs of damage. A badly worn cable or damaged connector may interfere with scanner operation. Contact your distributor for information about cable replacement. Cable replacement instructions are on [page 13-2](#).

Replacing Cables in Corded Scanners

The standard interface cable is attached to the scanner with an 10-pin modular connector. When properly seated, the connector is held in the scanner's handle by a flexible retention tab. The interface cable is designed to be field replaceable.

- Order replacement cables from Honeywell or from an authorized distributor.
- When ordering a replacement cable, specify the cable part number of the original interface cable.

Replacing a Xenon Interface Cable

1. Turn the power to the host system OFF.
2. Disconnect the scanner's cable from the terminal or computer.
3. Locate the small hole on the back of the scanner's handle. This is the cable release.
4. Straighten one end of a paper clip.
5. Insert the end of the paper clip into the small hole and press in. This depresses the retention tab, releasing the connector. Pull the connector out while maintaining pressure on the paper clip, then remove the paper clip.
6. Replace with the new cable.
Insert the connector into the opening and press firmly. The connector is keyed to go in only one way, and will click into place.

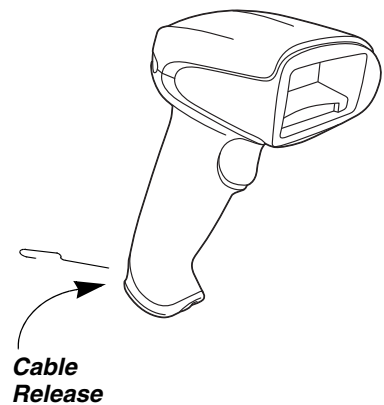

Replacing a Granit Interface Cable

1. Turn the power to the host system OFF.
2. Disconnect the scanner's cable from the terminal or computer.
3. Unscrew the locking plate on the bottom of the scanner.
4. Slide the locking plate away from the connector and pull the cable out of the scanner.
5. Replace with the new cable.
Insert the connector into the opening and press firmly.
6. Slide the locking plate over the base of the connector to secure the cable, and screw the plate into place.

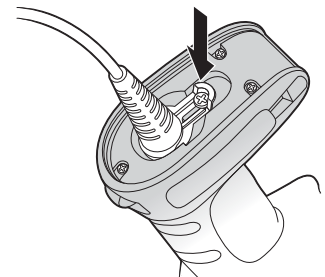
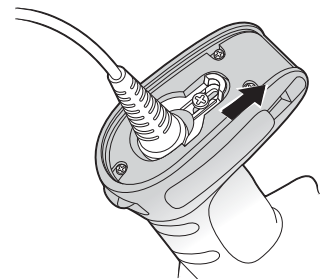

Replacing Cables and Batteries in Cordless Systems

Replacing an Interface Cable in a Base

1. Turn the power to the host system OFF.
2. Disconnect the base's cable from the terminal or computer.
3. Turn the base upside down.

4. Pull the connector out while maintaining pressure on the connector release clip.

CCB01-010BT Base :

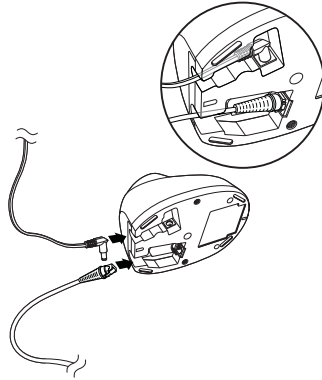

CCB02-100BT Base :

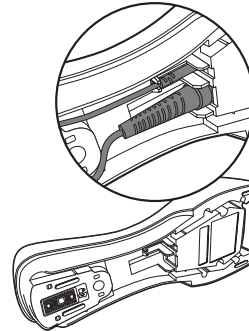

5. Replace with the new cable.
Insert the connector into the opening and press firmly. The connector is keyed to go in only one way, and will click into place.

Changing a Xenon Scanner Battery

1. Use a Phillips head screwdriver to remove the screw from the end cap.
2. Remove the end cap and remove the battery from the handle.
3. Insert replacement battery.
4. Replace end cap and screw.

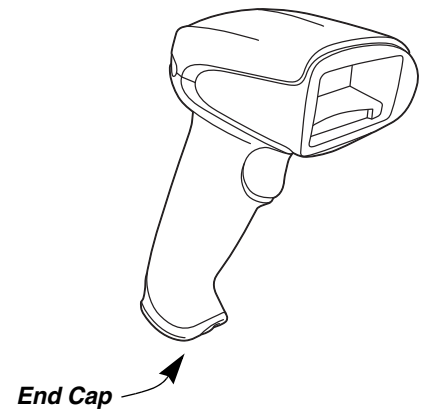

Changing a Granit Scanner Battery

1. Twist the tab in the bottom of the end cap and open the hinged battery door.
(When new, the battery door may stick. Use pliers to twist the tab and open the door until it loosens up.)
2. Remove the battery from the handle.
3. Insert replacement battery.
4. Close the battery door and twist the tab to lock it.

Note: The battery door is designed to pop off the hinge if the scanner is dropped while changing a battery. If this occurs, simply snap it back on.

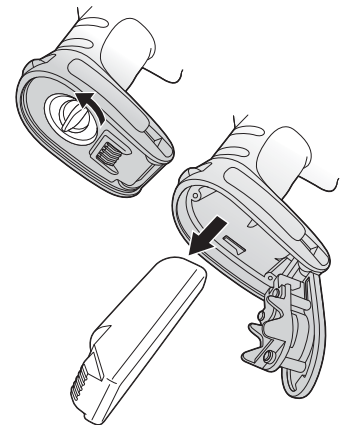

Troubleshooting a Corded Scanner

The scanner automatically performs self-tests whenever you turn it on. If your scanner is not functioning properly, review the following Troubleshooting Guide to try to isolate the problem.

Is the power on? Is the aimer on?

If the aimer isn't illuminated, check that:

- The cable is connected properly.
- The host system power is on (if external power isn't used).
- The trigger works.

Is the scanner having trouble reading your symbols?

If the scanner isn't reading symbols well, check that the symbols:

- Aren't smeared, rough, scratched, or exhibiting voids.
- Aren't coated with frost or water droplets on the surface.
- Are enabled in the scanner or in the decoder to which the scanner connects.

Is the bar code displayed but not entered?

The bar code is displayed on the host device correctly, but you still have to press a key to enter it (the Enter/Return key or the Tab key, for example).

- You need to program a suffix. Programming a suffix enables the scanner to output the bar code data plus the key you need (such as "CR") to enter the data into your application. Refer to [Prefix/Suffix Overview](#) on page 5-1 for further information.

Does the scanner read the bar code incorrectly?

If the scanner reads a bar code, but the data is not displayed correctly on the host screen:

- The scanner may not be programmed for the appropriate terminal interface. For example, you scan "12345" and the host displays "@es%."

Reprogram the scanner with the correct Plug and Play bar code. See [Programming the Interface](#) beginning on page 2-1.

- The scanner may not be programmed to output your bar code data properly. For example, you scan "12345" and the host displays "A12345B."

Reprogram the scanner with the proper symbology selections. See [Chapter 7](#).

The scanner won't read your bar code at all.

1. Scan the sample bar codes in the back of this manual. If the scanner reads the sample bar codes, check that your bar code is readable. Verify that your bar code symbology is enabled (see [Chapter 7](#)).
2. If the scanner still can't read the sample bar codes, scan [All Symbologies On](#), page 7-1.

If you aren't sure what programming options have been set in the scanner, or if you want the factory default settings restored, refer to [Resetting the Factory Defaults](#) on page 10-4.

Troubleshooting a Cordless System

Troubleshooting a Base

Note: Visit the Services and Support section of our website (www.honeywellaidc.com) to check for the latest software for both the scanner and the base.

If your base is not functioning properly, review the following troubleshooting guidelines to try to isolate the problem.

Is the red LED on?

If the red LED isn't illuminated, check that:

- The power cable is connected properly and there is power at the power source.
- The host system power is on (if external power isn't used).

Is the green LED on?

If the green LED isn't illuminated, check that:

- The scanner is correctly placed in the base.
- There is external power or 12 volt host power.
- Charge mode is turned on. (See ["Beeper and LED Sequences and Meaning"](#) on page 3-5)
- The battery is not bad or deeply discharged. In some cases, the scanner's battery may trickle charge to bring it into an acceptable level and then transition to a normal charge cycle.

Troubleshooting a Cordless Scanner

Note: Make sure that your scanner's battery is charged. Visit the Services and Support section of our website (www.honeywellaidc.com) to check for the latest software for both the scanner and the base or Access Point.

Is the scanner having trouble reading your symbols?

If the scanner isn't reading symbols well, check that the symbols:

- Aren't smeared, rough, scratched, or exhibiting voids.
- Aren't coated with frost or water droplets on the surface.
- Are enabled in the base or Access Point to which the scanner connects.

Is the bar code displayed but not entered into the application?

The bar code is displayed on the host device correctly, but you still have to press a key to enter it (the Enter/Return key or the Tab key, for example).

- You need to program a suffix. Programming a suffix enables the scanner to output the bar code data plus the key you need (such as "CR") to enter the data into your application. Refer to [Prefix/Suffix Overview](#) on page 5-1 for further information.

Does the scanner read the bar code incorrectly?

If the scanner reads a bar code, but the data is not displayed correctly on the host screen:

- The base or Access Point may not be programmed for the appropriate terminal interface. For example, you scan "12345" and the host displays "@es%."

Reprogram the base/Access Point with the correct Plug and Play bar code. See [Programming the Interface](#) beginning on page 2-1.

- The base or Access Point may not be programmed to output your bar code data properly. For example, you scan "12345" and the host displays "A12345B."

Reprogram the base/Access Point with the proper symbology selections. See [Chapter 7](#).

The scanner won't read your bar code at all.

- Scan the sample bar codes in the back of this manual. If the scanner reads the sample bar codes, check that your bar code is readable.

Verify that your bar code symbology is enabled (see [Chapter 7](#)).

If the scanner still can't read the sample bar codes, scan [All Symbologies](#) on page 7-1.



Customer Support

Technical Assistance

If you need assistance installing or troubleshooting your device, please contact us by using one of the methods below:

Knowledge Base: www.hsmknowledgebase.com

Our Knowledge Base provides thousands of immediate solutions. If the Knowledge Base cannot help, our Technical Support Portal (see below) provides an easy way to report your problem or ask your question.

Technical Support Portal: www.hsmsupportportal.com

The Technical Support Portal not only allows you to report your problem, but it also provides immediate solutions to your technical issues by searching our Knowledge Base. With the Portal, you can submit and track your questions online and send and receive attachments.

Web form: www.hsmcontactsupport.com

You can contact our technical support team directly by filling out our online support form. Enter your contact details and the description of the question/problem.

Telephone: www.honeywellaidc.com/locations

For our latest contact information, please check our website at the link above.

Product Service and Repair

Honeywell International Inc. provides service for all of its products through service centers throughout the world. To obtain warranty or non-warranty service, please visit www.honeywellaidc.com and select **Support > Contact Service and Repair** to see your region's instructions on how to obtain a Return Material Authorization number (RMA #). You should do this prior to returning the product.

Limited Warranty

Honeywell International Inc. ("HII") warrants its products to be free from defects in materials and workmanship and to conform to HII's published specifications applicable to the products purchased at the time of shipment. This warranty does not cover any HII product which is (i) improperly installed or used; (ii) damaged by accident or negligence, including failure to follow the proper maintenance, service, and cleaning schedule; or (iii) damaged as a result of (A) modification or alteration by the purchaser or other party, (B) excessive voltage or current supplied to or drawn from the interface connections, (C) static electricity or electrostatic discharge, (D) operation under conditions beyond the specified operating parameters, or (E) repair or service of the product by anyone other than HII or its authorized representatives.

This warranty shall extend from the time of shipment for the duration published by HII for the product at the time of purchase ("Warranty Period"). Any defective product must be returned (at purchaser's expense) during the Warranty Period to HII factory or authorized service center for inspection. No product will be accepted by HII without a Return Materials Authorization, which may be obtained by contacting HII. In the event that the product is returned to HII or its authorized service center within the Warranty Period and HII determines to its satisfaction that the product is defective due to defects in materials or workmanship, HII, at its sole option, will either repair or replace the product without charge, except for return shipping to HII.

EXCEPT AS MAY BE OTHERWISE PROVIDED BY APPLICABLE LAW, THE FOREGOING WARRANTY IS IN LIEU OF ALL OTHER COVENANTS OR WARRANTIES, EITHER EXPRESSED OR IMPLIED, ORAL OR WRITTEN, INCLUDING, WITHOUT LIMITATION, ANY IMPLIED WARRANTIES OF MERCHANTABILITY OR FITNESS FOR A PARTICULAR PURPOSE, OR NON-INFRINGEMENT.

HII'S RESPONSIBILITY AND PURCHASER'S EXCLUSIVE REMEDY UNDER THIS WARRANTY IS LIMITED TO THE REPAIR OR REPLACEMENT OF THE DEFECTIVE PRODUCT WITH NEW OR REFURBISHED PARTS. IN NO EVENT SHALL HII BE LIABLE FOR INDIRECT, INCIDENTAL, OR CONSEQUENTIAL DAMAGES, AND, IN NO EVENT, SHALL ANY LIABILITY OF HII ARISING IN CONNECTION WITH ANY PRODUCT SOLD HEREUNDER (WHETHER SUCH LIABILITY ARISES FROM A CLAIM BASED ON CONTRACT, WARRANTY, TORT, OR OTHERWISE) EXCEED THE ACTUAL AMOUNT PAID TO HII FOR THE PRODUCT. THESE LIMITATIONS ON LIABILITY SHALL REMAIN IN FULL FORCE AND EFFECT

EVEN WHEN HII MAY HAVE BEEN ADVISED OF THE POSSIBILITY OF SUCH INJURIES, LOSSES, OR DAMAGES. SOME STATES, PROVINCES, OR COUNTRIES DO NOT ALLOW THE EXCLUSION OR LIMITATIONS OF INCIDENTAL OR CONSEQUENTIAL DAMAGES, SO THE ABOVE LIMITATION OR EXCLUSION MAY NOT APPLY TO YOU.

All provisions of this Limited Warranty are separate and severable, which means that if any provision is held invalid and unenforceable, such determination shall not affect the validity of enforceability of the other provisions hereof. Use of any peripherals not provided by the manufacturer may result in damage not covered by this warranty. This includes but is not limited to: cables, power supplies, cradles, and docking stations. HII extends these warranties only to the first end-users of the products. These warranties are non-transferable.

The duration of the limited warranty for the Xenon 1900 and 1910 scanners is five (5) years.

The duration of the limited warranty for the Xenon 1902 and 1912 scanners and CCB01-010BT Charge Base is three (3) years.

The duration of the limited warranty for the Granit 1910i and 1911i scanners and CCB02-100BT Charge Base is three (3) years.

The duration of the limited warranty for the Xenon or Granit battery is one (1) year.

Reference Charts

Symbology Charts

Note: “m” represents the AIM modifier character. Refer to International Technical Specification, Symbology Identifiers, for AIM modifier character details.

Prefix/Suffix entries for specific symbologies override the universal (All Symbologies, 99) entry.

Refer to [Data Editing](#) beginning on page 5-1 and [Data Formatting](#) beginning on page 6-1 for information about using Code ID and AIM ID.

Linear Symbologies

| Symbology | AIM | | Honeywell | |
|------------------------------------|-----|---------------------------|-----------|-----|
| | ID | Possible modifiers (m) | ID | Hex |
| All Symbologies | | | | 99 |
| Codabar |]Fm | 0-1 | a | 61 |
| Code 11 |]H3 | | h | 68 |
| Code 128 |]Cm | 0, 1, 2, 4 | j | 6A |
| Code 32 Pharmaceutical (PARAF) |]X0 | | < | 3C |
| Code 39 (supports Full ASCII mode) |]Am | 0, 1, 3, 4, 5, 7 | b | 62 |
| TCIF Linked Code 39 (TLC39) |]L2 | | T | 54 |
| Code 93 and 93i |]Gm | 0-9, A-Z, a-m | i | 69 |
| EAN |]Em | 0, 1, 3, 4 | d | 64 |
| EAN-13 (including Bookland EAN) |]E0 | | d | 64 |
| EAN-13 with Add-On |]E3 | | d | 64 |
| EAN-13 with Extended Coupon Code |]E3 | | d | 64 |
| EAN-8 |]E4 | | D | 44 |
| EAN-8 with Add-On |]E3 | | D | 44 |
| GS1 | | | | |
| GS1 DataBar |]em | 0 | y | 79 |
| GS1 DataBar Limited |]em | | { | 7B |
| GS1 DataBar Expanded |]em | | } | 7D |
| GS1-128 |]C1 | | l | 49 |
| 2 of 5 | | | | |
| China Post (Hong Kong 2 of 5) |]X0 | | Q | 51 |
| Interleaved 2 of 5 |]Im | 0, 1, 3 | e | 65 |
| Matrix 2 of 5 |]X0 | | m | 6D |
| NEC 2 of 5 |]X0 | | Y | 59 |
| Straight 2 of 5 IATA |]Rm | 0, 1, 3 | f | 66 |
| Straight 2 of 5 Industrial |]S0 | | f | 66 |
| MSI |]Mm | 0, 1 | g | 67 |
| Telepen |]Bm | | t | 74 |
| UPC | | 0, 1, 2, 3, 8, 9, A, B, C | | |

| Symbology | AIM | | Honeywell | |
|---------------------------------|-----|------------------------|-----------|-----|
| | ID | Possible modifiers (m) | ID | Hex |
| UPC-A |]E0 | | c | 63 |
| UPC-A with Add-On |]E3 | | c | 63 |
| UPC-A with Extended Coupon Code |]E3 | | c | 63 |
| UPC-E |]E0 | | E | 45 |
| UPC-E with Add-On |]E3 | | E | 45 |
| UPC-E1 |]X0 | | E | 45 |

| | | | | |
|-----------------------|--|--|---|------|
| Add Honeywell Code ID | | | | 5C80 |
| Add AIM Code ID | | | | 5C81 |
| Add Backslash | | | | 5C5C |
| Batch mode quantity | | | 5 | 35 |

2D Symbologies

| Symbology | AIM | | Honeywell | |
|--------------------------------------|-----|------------------------|-----------|-----|
| | ID | Possible modifiers (m) | ID | Hex |
| <i>All Symbologies</i> | | | | 99 |
| Aztec Code |]zm | 0-9, A-C | z | 7A |
| Chinese Sensible Code (Han Xin Code) |]X0 | | H | 48 |
| Codablock A |]O6 | 0, 1, 4, 5, 6 | V | 56 |
| Codablock F |]Om | 0, 1, 4, 5, 6 | q | 71 |
| Code 49 |]Tm | 0, 1, 2, 4 | l | 6C |
| Data Matrix |]dm | 0-6 | w | 77 |
| GS1 |]em | 0-3 | y | 79 |
| GS1 Composite |]em | 0-3 | y | 79 |
| GS1 DataBar Omnidirectional |]em | 0-3 | y | 79 |
| MaxiCode |]Um | 0-3 | x | 78 |
| PDF417 |]Lm | 0-2 | r | 72 |
| MicroPDF417 |]Lm | 0-5 | R | 52 |
| QR Code |]Qm | 0-6 | s | 73 |
| Micro QR Code |]Qm | | s | 73 |

Postal Symbologies

| Symbology | AIM | | Honeywell | |
|------------------------|-----|------------------------|-----------|-----|
| | ID | Possible modifiers (m) | ID | Hex |
| <i>All Symbologies</i> | | | | 99 |
| Australian Post |]X0 | | A | 41 |

| Symbology | AIM | | Honeywell | |
|---------------------------|-----|---------------------------|-----------|-----|
| | ID | Possible modifiers (m) | ID | Hex |
| British Post |]X0 | | B | 42 |
| Canadian Post |]X0 | | C | 43 |
| China Post |]X0 | | Q | 51 |
| InfoMail |]X0 | | , | 2c |
| Intelligent Mail Bar Code |]X0 | | M | 4D |
| Japanese Post |]X0 | | J | 4A |
| KIX (Netherlands) Post |]X0 | | K | 4B |
| Korea Post |]X0 | | ? | 3F |
| Planet Code |]X0 | | L | 4C |
| Postal-4i |]X0 | | N | 4E |
| Postnet |]X0 | | P | 50 |

ASCII Conversion Chart (Code Page 1252)

In keyboard applications, ASCII Control Characters can be represented in 3 different ways, as shown below. The CTRL+X function is OS and application dependent. The following table lists some commonly used Microsoft functionality. This table applies to U.S. style keyboards. Certain characters may differ depending on your Country Code/PC regional settings.

| Non-printable characters | | ASCII control | Keyboard Control + ASCII (CTRL+X) Mode | | |
|--------------------------|-----|---------------|--|--|---------------------|
| DEC | HEX | Char | Control + X Mode Off (KBDCAS0) | Windows Mode Control + X Mode On (KBDCAS2) | |
| | | | | CTRL + X | CTRL + X function |
| 0 | 00 | NUL | Reserved | CTRL+ @ | |
| 1 | 01 | SOH | NP Enter | CTRL+ A | Select all |
| 2 | 02 | STX | Caps Lock | CTRL+ B | Bold |
| 3 | 03 | ETX | ALT Make | CTRL+ C | Copy |
| 4 | 04 | EOT | ALT Break | CTRL+ D | Bookmark |
| 5 | 05 | ENQ | CTRL Make | CTRL+ E | Center |
| 6 | 06 | ACK | CTRL Break | CTRL+ F | Find |
| 7 | 07 | BEL | Enter / Ret | CTRL+ G | |
| 8 | 08 | BS | (Apple Make) | CTRL+ H | History |
| 9 | 09 | HT | Tab | CTRL+ I | Italic |
| 10 | 0A | LF | (Apple Break) | CTRL+ J | Justify |
| 11 | 0B | VT | Tab | CTRL+ K | hyperlink |
| 12 | 0C | FF | Delete | CTRL+ L | list, left align |
| 13 | 0D | CR | Enter / Ret | CTRL+ M | |
| 14 | 0E | SO | Insert | CTRL+ N | New |
| 15 | 0F | SI | ESC | CTRL+ O | Open |
| 16 | 10 | DLE | F11 | CTRL+ P | Print |
| 17 | 11 | DC1 | Home | CTRL+ Q | Quit |
| 18 | 12 | DC2 | PrtScn | CTRL+ R | |
| 19 | 13 | DC3 | Backspace | CTRL+ S | Save |
| 20 | 14 | DC4 | Back Tab | CTRL+ T | |
| 21 | 15 | NAK | F12 | CTRL+ U | |
| 22 | 16 | SYN | F1 | CTRL+ V | Paste |

| Non-printable characters | | ASCII control | Keyboard Control + ASCII (CTRL+X) Mode | | |
|--------------------------|-----|---------------|--|--|-------------------|
| DEC | HEX | Char | Control + X Mode Off (KBDCAS0) | Windows Mode Control + X Mode On (KBDCAS2) | |
| | | | | CTRL + X | CTRL + X function |
| 23 | 17 | ETB | F2 | CTRL+ W | |
| 24 | 18 | CAN | F3 | CTRL+ X | |
| 25 | 19 | EM | F4 | CTRL+ Y | |
| 26 | 1A | SUB | F5 | CTRL+ Z | |
| 27 | 1B | ESC | F6 | CTRL+ [| |
| 28 | 1C | FS | F7 | CTRL+ \ | |
| 29 | 1D | GS | F8 | CTRL+] | |
| 30 | 1E | RS | F9 | CTRL+ ^ | |
| 31 | 1F | US | F10 | CTRL+ - | |
| 127 | 7F | ␣ | NP Enter | | |

Lower ASCII Reference Table

Note: Windows Code page 1252 and lower ASCII use the same characters.

| Printable Characters | | | | | | | | |
|----------------------|-----|-----------|-----|-----|-----------|-----|-----|-----------|
| DEC | HEX | Character | DEC | HEX | Character | DEC | HEX | Character |
| 32 | 20 | <SPACE> | 64 | 40 | @ | 96 | 60 | ` |
| 33 | 21 | ! | 65 | 41 | A | 97 | 61 | a |
| 34 | 22 | " | 66 | 42 | B | 98 | 62 | b |
| 35 | 23 | # | 67 | 43 | C | 99 | 63 | c |
| 36 | 24 | \$ | 68 | 44 | D | 100 | 64 | d |
| 37 | 25 | % | 69 | 45 | E | 101 | 65 | e |
| 38 | 26 | & | 70 | 46 | F | 102 | 66 | f |
| 39 | 27 | ' | 71 | 47 | G | 103 | 67 | g |
| 40 | 28 | (| 72 | 48 | H | 104 | 68 | h |
| 41 | 29 |) | 73 | 49 | I | 105 | 69 | i |
| 42 | 2A | * | 74 | 4A | J | 106 | 6A | j |
| 43 | 2B | + | 75 | 4B | K | 107 | 6B | k |
| 44 | 2C | , | 76 | 4C | L | 108 | 6C | l |
| 45 | 2D | - | 77 | 4D | M | 109 | 6D | m |
| 46 | 2E | . | 78 | 4E | N | 110 | 6E | n |
| 47 | 2F | / | 79 | 4F | O | 111 | 6F | o |
| 48 | 30 | 0 | 80 | 50 | P | 112 | 70 | p |
| 49 | 31 | 1 | 81 | 51 | Q | 113 | 71 | q |
| 50 | 32 | 2 | 82 | 52 | R | 114 | 72 | r |
| 51 | 33 | 3 | 83 | 53 | S | 115 | 73 | s |
| 52 | 34 | 4 | 84 | 54 | T | 116 | 74 | t |
| 53 | 35 | 5 | 85 | 55 | U | 117 | 75 | u |
| 54 | 36 | 6 | 86 | 56 | V | 118 | 76 | v |
| 55 | 37 | 7 | 87 | 57 | W | 119 | 77 | w |
| 56 | 38 | 8 | 88 | 58 | X | 120 | 78 | x |
| 57 | 39 | 9 | 89 | 59 | Y | 121 | 79 | y |
| 58 | 3A | : | 90 | 5A | Z | 122 | 7A | z |
| 59 | 3B | ; | 91 | 5B | [| 123 | 7B | { |
| 60 | 3C | < | 92 | 5C | \ | 124 | 7C | |
| 61 | 3D | = | 93 | 5D |] | 125 | 7D | } |
| 62 | 3E | > | 94 | 5E | ^ | 126 | 7E | ~ |

| Printable Characters (Continued) | | | | | | | | |
|----------------------------------|-----|-----------|-----|-----|-----------|-----|-----|-----------|
| DEC | HEX | Character | DEC | HEX | Character | DEC | HEX | Character |
| 63 | 3F | ? | 95 | 5F | _ | 127 | 7F | Δ |

| Extended ASCII Characters | | | | | | |
|---------------------------|-----|---------|-------|-------------------------------|---------------|--|
| DEC | HEX | CP 1252 | ASCII | Alternate Extended | PS2 Scan Code | |
| 128 | 80 | € | Ç | up arrow ↑ | 0x48 | |
| 129 | 81 | | ü | down arrow ↓ | 0x50 | |
| 130 | 82 | , | é | right arrow → | 0x4B | |
| 131 | 83 | f | â | left arrow ← | 0x4D | |
| 132 | 84 | „ | ä | Insert | 0x52 | |
| 133 | 85 | … | à | Delete | 0x53 | |
| 134 | 86 | † | á | Home | 0x47 | |
| 135 | 87 | ‡ | ç | End | 0x4F | |
| 136 | 88 | ^ | ê | Page Up | 0x49 | |
| 137 | 89 | ‰ | ë | Page Down | 0x51 | |
| 138 | 8A | Š | è | Right ALT | 0x38 | |
| 139 | 8B | ‹ | ï | Right CTRL | 0x1D | |
| 140 | 8C | Œ | î | Reserved | n/a | |
| 141 | 8D | | ì | Reserved | n/a | |
| 142 | 8E | Ž | Ä | Numeric Keypad Enter | 0x1C | |
| 143 | 8F | | Å | Numeric Keypad / | 0x35 | |
| 144 | 90 | | É | F1 | 0x3B | |
| 145 | 91 | ‘ | æ | F2 | 0x3C | |
| 146 | 92 | ’ | Æ | F3 | 0x3D | |
| 147 | 93 | “ | ô | F4 | 0x3E | |
| 148 | 94 | ” | ö | F5 | 0x3F | |
| 149 | 95 | • | ò | F6 | 0x40 | |
| 150 | 96 | — | û | F7 | 0x41 | |
| 151 | 97 | — | ù | F8 | 0x42 | |
| 152 | 98 | ˜ | ÿ | F9 | 0x43 | |
| 153 | 99 | ™ | Ö | F10 | 0x44 | |
| 154 | 9A | š | Ü | F11 | 0x57 | |
| 155 | 9B | › | ø | F12 | 0x58 | |
| 156 | 9C | œ | £ | Numeric Keypad + | 0x4E | |
| 157 | 9D | | ¥ | Numeric Keypad - | 0x4A | |
| 158 | 9E | ž | Pts | Numeric Keypad * | 0x37 | |
| 159 | 9F | ÿ | f | Caps Lock | 0x3A | |
| 160 | A0 | | á | Num Lock | 0x45 | |
| 161 | A1 | ı | í | Left Alt | 0x38 | |
| 162 | A2 | ç | ó | Left Ctrl | 0x1D | |
| 163 | A3 | £ | ú | Left Shift | 0x2A | |
| 164 | A4 | ¤ | ñ | Right Shift | 0x36 | |
| 165 | A5 | ¥ | Ñ | Print Screen | n/a | |
| 166 | A6 | ı | ª | Tab | 0x0F | |
| 167 | A7 | § | º | Shift Tab | 0x8F | |
| 168 | A8 | ¨ | ¿ | Enter | 0x1C | |
| 169 | A9 | © | ƒ | Esc | 0x01 | |
| 170 | AA | ª | ¬ | Alt Make | 0x36 | |
| 171 | AB | « | ½ | Alt Break | 0xB6 | |
| 172 | AC | ¬ | ¼ | Control Make | 0x1D | |
| 173 | AD | | ı | Control Break | 0x9D | |
| 174 | AE | ® | « | Alt Sequence with 1 Character | 0x36 | |

| Extended ASCII Characters (Continued) | | | | | |
|---------------------------------------|-----|---------|-------|--------------------------------|---------------|
| DEC | HEX | CP 1252 | ASCII | Alternate Extended | PS2 Scan Code |
| 175 | AF | — | » | Ctrl Sequence with 1 Character | 0x1D |
| 176 | B0 | ° | ☐ | | |
| 177 | B1 | ± | ☐ | | |
| 178 | B2 | ² | ☐ | | |
| 179 | B3 | ³ | | | |
| 180 | B4 | ´ | | | |
| 181 | B5 | µ | | | |
| 182 | B6 | ¶ | | | |
| 183 | B7 | · | | | |
| 184 | B8 | ¸ | | | |
| 185 | B9 | ¹ | | | |
| 186 | BA | º | | | |
| 187 | BB | » | | | |
| 188 | BC | ¼ | | | |
| 189 | BD | ½ | | | |
| 190 | BE | ¾ | | | |
| 191 | BF | ¿ | | | |
| 192 | C0 | À | | | |
| 193 | C1 | Á | | | |
| 194 | C2 | Â | | | |
| 195 | C3 | Ã | | | |
| 196 | C4 | Ä | | | |
| 197 | C5 | Å | | | |
| 198 | C6 | Æ | | | |
| 199 | C7 | Ç | | | |
| 200 | C8 | È | | | |
| 201 | C9 | É | | | |
| 202 | CA | Ê | | | |
| 203 | CB | Ë | | | |
| 204 | CC | Ì | | | |
| 205 | CD | Í | | | |
| 206 | CE | Î | | | |
| 207 | CF | Ï | | | |
| 208 | D0 | Ð | | | |
| 209 | D1 | Ñ | | | |
| 210 | D2 | Ò | | | |
| 211 | D3 | Ó | | | |
| 212 | D4 | Ô | | | |
| 213 | D5 | Õ | | | |
| 214 | D6 | Ö | | | |
| 215 | D7 | × | | | |
| 216 | D8 | Ø | | | |
| 217 | D9 | Ù | | | |
| 218 | DA | Ú | | | |
| 219 | DB | Û | ■ | | |
| 220 | DC | Ü | ■ | | |
| 221 | DD | Ý | ■ | | |
| 222 | DE | Þ | ■ | | |
| 223 | DF | ß | ■ | | |
| 224 | E0 | à | α | | |
| 225 | E1 | á | β | | |
| 226 | E2 | â | Γ | | |

| Extended ASCII Characters (Continued) | | | | | |
|---------------------------------------|-----|---------|-------|--------------------|---------------|
| DEC | HEX | CP 1252 | ASCII | Alternate Extended | PS2 Scan Code |
| 227 | E3 | ã | π | | |
| 228 | E4 | ä | Σ | | |
| 229 | E5 | å | σ | | |
| 230 | E6 | æ | μ | | |
| 231 | E7 | ç | τ | | |
| 232 | E8 | è | Φ | | |
| 233 | E9 | é | Θ | | |
| 234 | EA | ê | Ω | | |
| 235 | EB | ë | ō | | |
| 236 | EC | ì | ∞ | | |
| 237 | ED | í | φ | | |
| 238 | EE | î | ε | | |
| 239 | EF | ï | ∩ | | |
| 240 | F0 | ð | ≡ | | |
| 241 | F1 | ñ | ± | | |
| 242 | F2 | ò | ≥ | | |
| 243 | F3 | ó | ≤ | | |
| 244 | F4 | ô | ∫ | | |
| 245 | F5 | õ | ∫ | | |
| 246 | F6 | ö | + | | |
| 247 | F7 | ÷ | ≈ | | |
| 248 | F8 | ø | ° | | |
| 249 | F9 | ù | · | | |
| 250 | FA | ú | · | | |
| 251 | FB | û | √ | | |
| 252 | FC | ü | n | | |
| 253 | FD | ý | ² | | |
| 254 | FE | þ | ■ | | |
| 255 | FF | ÿ | | | |

ISO 2022/ISO 646 Character Replacements

Code pages define the mapping of character codes to characters. If the data received does not display with the proper characters, it may be because the bar code being scanned was created using a code page that is different from the one the host program is expecting. If this is the case, select the code page with which the bar codes were created. The data characters should then appear properly.

| Code Page Selection Method/Country | Standard | Keyboard Country | Honeywell Code Page Option |
|--|------------------|------------------|----------------------------|
| United States (standard ASCII) | ISO/IEC 646-IRV | n/a | 1 |
| Automatic National Character Replacement | ISO/IEC 2022 | n/a | 2 (default) |
| Binary Code page | n/a | n/a | 3 |
| <i>Default "Automatic National Character replacement" will select the below Honeywell Code Page options for Code 128, Code 39 and Code 93.</i> | | | |
| United States | ISO/IEC 646-06 | 0 | 1 |
| Canada | ISO /IEC 646-121 | 54 | 95 |
| Canada | ISO /IEC 646-122 | 18 | 96 |
| Japan | ISO/IEC 646-14 | 28 | 98 |

| Code Page Selection Method/Country | Standard | Keyboard Country | Honeywell Code Page Option |
|-------------------------------------|------------------|------------------|----------------------------|
| China | ISO/IEC 646-57 | 92 | 99 |
| Great Britain (UK) | ISO /IEC 646-04 | 7 | 87 |
| France | ISO /IEC 646-69 | 3 | 83 |
| Germany | ISO/IEC646-21 | 4 | 84 |
| Switzerland | ISO /IEC 646-CH | 6 | 86 |
| Sweden / Finland (extended Annex C) | ISO/IEC 646-11 | 2 | 82 |
| Ireland | ISO /IEC 646-207 | 73 | 97 |
| Denmark | ISO/IEC 646-08 | 8 | 88 |
| Norway | ISO/IEC 646-60 | 9 | 94 |
| Italy | ISO/IEC 646-15 | 5 | 85 |
| Portugal | ISO/IEC 646-16 | 13 | 92 |
| Spain | ISO/IEC 646-17 | 10 | 90 |
| Spain | ISO/IEC 646-85 | 51 | 91 |

| Dec | | | 35 | 36 | 64 | 91 | 92 | 93 | 94 | 96 | 123 | 124 | 125 | 126 |
|----------------|-------------------------|---------------------------|--|----|----|----|----|----|----|----|-----|-----|-----|-----|
| Hex | | | 23 | 24 | 40 | 5B | 5C | 5D | 5E | 60 | 7B | 7C | 7D | 7E |
| US | 0 | 1 | # | \$ | @ | [| \ |] | ^ | ` | { | | } | ~ |
| CA | 54 | 95 | # | \$ | à | â | ç | ê | î | ô | é | ù | è | û |
| CA | 18 | 96 | # | \$ | à | â | ç | ê | É | ô | é | ù | è | û |
| JP | 28 | 98 | # | \$ | @ | [| ¥ |] | ^ | ` | { | | } | - |
| CN | 92 | 99 | # | ¥ | @ | [| \ |] | ^ | ` | { | | } | - |
| GB | 7 | 87 | £ | \$ | @ | [| \ |] | ^ | ` | { | | } | ~ |
| FR | 3 | 83 | £ | \$ | à | ° | ç | § | ^ | μ | é | ù | è | .. |
| DE | 4 | 84 | # | \$ | § | Ä | Ö | Ü | ^ | ` | ä | ö | ü | ß |
| CH | 6 | 86 | ù | \$ | à | é | ç | ê | î | ô | ä | ö | ü | û |
| SE/FI | 2 | 82 | # | ¤ | É | Ä | Ö | Å | Ü | é | ä | ö | å | ü |
| DK | 8 | 88 | # | \$ | @ | Æ | Ø | Å | ^ | ` | æ | ø | å | ~ |
| NO | 9 | 94 | # | \$ | @ | Æ | Ø | Å | ^ | ` | æ | ø | å | .. |
| IE | 73 | 97 | £ | \$ | Ó | É | Í | Ú | Á | ó | é | í | ú | á |
| IT | 5 | 85 | £ | \$ | § | ° | ç | é | ^ | ù | à | ò | è | ì |
| PT | 13 | 92 | # | \$ | § | Ã | Ç | Õ | ^ | ` | ã | ç | õ | ° |
| ES | 10 | 90 | # | \$ | § | ı | Ñ | ¿ | ^ | ` | ° | ñ | ç | ~ |
| ES | 51 | 91 | # | \$ | · | ı | Ñ | Ç | ¿ | ` | · | ñ | ç | .. |
| COUNTRY | Country Keyboard | Honeywell CodePage | ISO / IEC 646 National Character Replacements | | | | | | | | | | | |

Unicode Key Maps

| | | | | | | | | | | | | | | | | | | | | |
|----|----|----|----|----|----|----|----|----|----|----|----|----|----|----|----|----|----|----|----|----|
| 6E | 70 | 71 | 72 | 73 | 74 | 75 | 76 | 77 | 78 | 79 | 7A | 7B | 7C | 7D | 7E | 5A | 5F | 64 | 69 | |
| 01 | 02 | 03 | 04 | 05 | 06 | 07 | 08 | 09 | 0A | 0B | 0C | 0D | 0F | 4B | 50 | 55 | 5B | 60 | 65 | 6A |
| 10 | 11 | 12 | 13 | 14 | 15 | 16 | 17 | 18 | 19 | 1A | 1B | 1C | 1D | 4C | 51 | 56 | 5C | 61 | 66 | 6C |
| 1E | 1F | 20 | 21 | 22 | 23 | 24 | 25 | 26 | 27 | 28 | 29 | 2B | | 53 | 5D | 62 | 67 | 6C | | |
| 2C | 2E | 2F | 30 | 31 | 32 | 33 | 34 | 35 | 36 | 37 | 39 | 4F | 54 | 59 | 63 | 68 | 6C | | | |
| 3A | 3B | 3C | | | 3D | | | | 3E | 3F | 38 | 40 | | | | | | | | |

104 Key U.S. Style Keyboard

| | | | | | | | | | | | | | | | | | | | | |
|----|----|----|----|----|----|----|----|----|----|----|----|----|----|----|----|----|----|----|----|----|
| 6E | 70 | 71 | 72 | 73 | 74 | 75 | 76 | 77 | 78 | 79 | 7A | 7B | 7C | 7D | 7E | 5A | 5F | 64 | 69 | |
| 01 | 02 | 03 | 04 | 05 | 06 | 07 | 08 | 09 | 0A | 0B | 0C | 0D | 0F | 4B | 50 | 55 | 5B | 60 | 65 | 6A |
| 10 | 11 | 12 | 13 | 14 | 15 | 16 | 17 | 18 | 19 | 1A | 1B | 1C | 2B | 4C | 51 | 56 | 5C | 61 | 66 | 6C |
| 1E | 1F | 20 | 21 | 22 | 23 | 24 | 25 | 26 | 27 | 28 | 29 | 2A | | 53 | 5D | 62 | 67 | 6C | | |
| 2C | 2D | 2E | 2F | 30 | 31 | 32 | 33 | 34 | 35 | 36 | 37 | 39 | 4F | 54 | 59 | 63 | 68 | 6C | | |
| 3A | 3B | 3C | | | 3D | | | | 3E | 3F | 38 | 40 | | | | | | | | |

105 Key European Style Keyboard

Sample Symbols

UPC-A



0 123456 7890

Interleaved 2 of 5



1234567890

EAN-13



9 780330 290951

Code 128



Code 128

Code 39

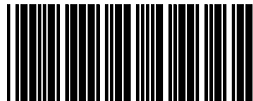

BC321

Codabar



A13579B

Code 93



123456-9\$

Code 2 of 5

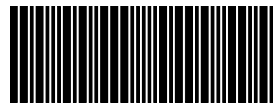

123456

Matrix 2 of 5



6543210

RSS-14



(01)00123456789012

Sample Symbols

PDF417



Car Registration

Code 49

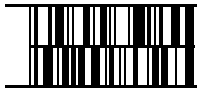

1234567890

Postnet



Zip Code

Data Matrix



Test Symbol

QR Code



Numbers

Aztec



Package Label

MaxiCode

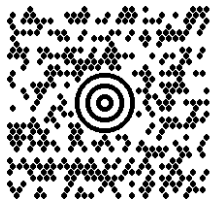

Test Message

Micro PDF417



Test Message

Programming Chart



Programming Chart



KAK
A



KBK
B



KCK
C



KDK
D



KEK
E



KFK
F



MNUSAV.
Save



MNUABT.
Discard



RESET_
Reset

*Note: If you make an error while scanning the letters or digits (before scanning Save), scan Discard, scan the correct letters or digits, and **Save** again.*

Honeywell Scanning & Mobility

9680 Old Bailes Road
Fort Mill, SC 29707

www.honeywellaidc.com