

Hand-Held Devices II



Software Configuration Manual

Datalogic Scanning, Inc.

959 Terry Street

Eugene, Oregon 97402

USA

Telephone: (541) 683-5700

Fax: (541) 345-7140

An Unpublished Work - All rights reserved. No part of the contents of this documentation or the procedures described therein may be reproduced or transmitted in any form or by any means without prior written permission of Datalogic Scanning, Inc. or its subsidiaries or affiliates ("Datalogic" or "Datalogic Scanning"). Owners of Datalogic products are hereby granted a non-exclusive, revocable license to reproduce and transmit this documentation for the purchaser's own internal business purposes. Purchaser shall not remove or alter any proprietary notices, including copyright notices, contained in this documentation and shall ensure that all notices appear on any reproductions of the documentation.

Should future revisions of this manual be published, you can acquire printed versions by contacting your Datalogic representative. Electronic versions may either be downloadable from the Datalogic website (www.scanning.datalogic.com) or provided on appropriate media. If you visit our website and would like to make comments or suggestions about this or other Datalogic publications, please let us know via the "Contact Datalogic" page.

Disclaimer

Datalogic has taken reasonable measures to provide information in this manual that is complete and accurate, however, Datalogic reserves the right to change any specification at any time without prior notice.

Datalogic is a registered trademark of Datalogic S.p.A. in many countries and the Datalogic logo is a trademark of Datalogic S.p.A. All other brand and product names referred to herein may be trademarks of their respective owners.

CONTENTS

1	INTRODUCTION	1
2	INITIAL SETUP	3
3	CONFIGURATION.....	12
	USB PARAMETERS	13
	Handshaking	14
	Ack/Nack Protocol.....	14
	Fifo	15
	Inter-character Delay	15
	Rx Timeout.....	16
	Serial Trigger Lock	16
	Keyboard Nationality	17
	Fifo	18
	Inter-character Delay	18
	Inter-code Delay.....	18
	Control Character Emulation.....	19
	RS232 PARAMETERS	20
	Baud Rate	21
	Parity.....	22
	Data Bits	22
	Stop Bits.....	23
	Handshaking	23
	Ack/Nack Protocol.....	24
	Fifo	24
	Inter-character Delay	25
	Rx Timeout.....	25
	Serial Trigger Lock	26
	WEDGE PARAMETERS	27
	Keyboard Nationality	28
	Caps Lock	29
	Caps Lock Auto-Recognition (IBM AT compatible only)	29
	Num Lock	30
	Inter-character Delay	30
	Inter-code Delay.....	31
	Control Character Emulation.....	31
	Keyboard Setting	32
	PEN EMULATION	34
	Operating Mode	35

Minimum Output Pulse.....	36
Conversion to Code 39	37
Overflow.....	37
Output Level.....	38
Idle Level.....	38
Inter-Block Delay.....	39
IBM 46xx	40
IBM Data Formatting.....	41
DATA FORMAT.....	42
Code Identifier.....	45
Custom Code Identifier	46
Header	47
Terminator.....	48
Field Adjustment	49
Field Adjustment Character.....	50
Code Length Tx	50
Character Replacement	51
POWER SAVE.....	53
Scan Rate	54
Sleep State/USB Suspend	54
Enter Sleep Timeout	55
Standby.....	55
READING PARAMETERS	56
Hand-Held Operation	57
Stand Operation.....	57
Hardware Trigger Signal	58
Trigger-off Timeout	58
Flash Mode	59
Reads per Cycle	59
Safety Time.....	60
Beeper Intensity.....	60
Beeper Tone	61
Beeper Type	61
Beeper Length	61
Good Read Spot Duration.....	62
Stand Recognition Beep	62
Automatic Operation Aiming Light.....	63
Aiming System	63
DECODING PARAMETERS.....	64
Ink Spread.....	65
Overflow Control	65
Interdigit Control.....	66

Decoding Safety.....	66
Puzzle Solver™	67

CODE SELECTION 68

EAN/UPC Family	70
2/5 Family	74
Code 39 Family.....	75
Code 128 Family.....	77
Code 93	78
Codabar Family.....	79
MSI	81
Plessey	82
Telepen.....	83
Delta IBM	84
Code 11	85
Code 16K.....	86
Code 49	86
RSS Codes	87

ADVANCED FORMATTING..... 88

Concatenation.....	89
Advanced Formatting.....	92

4 REFERENCES 107

A	HOST CONFIGURATION STRINGS	123
B	CODE IDENTIFIER TABLE.....	135
C	HEX/NUMERIC TABLE.....	135

CONFIGURATION METHODS

Reading Configuration Barcodes

If you wish to change the default settings, this manual provides complete configuration of your reader in an easy way:

To configure your reader:

- 1) Open the folded page in [Appendix C](#) with the hex-numeric table and keep it open during the device configuration.
- 2) Read the **Enter Configuration** code ONCE, available at the top of each page of configuration.
- 3) Modify the desired parameters in one or more sections following the procedures given for each group.
- 4) Read the **Exit and Save Configuration** code ONCE, available at the top of each page of configuration.

Reference notes describing the operation of the more complex parameters are given in chapter 4.

Using DL Sm@rtSet

DL Sm@rtSet is a Windows-based utility program providing a quick and user-friendly configuration method via the RS232 or USB-COM interfaces.

It also allows upgrading the software of the connected device (see the DL Sm@rtSet User's Manual for more details).

Copy Command

A previously configured reader (Master device), can be used to send its configuration directly to other readers of the same type. The particular procedure for each device is given in par. 4.9.

Sending Configuration Strings from Host

An alternative configuration method is provided in Appendix A using the RS232 or USB interfaces. This method is particularly useful when many devices need to be configured with the same settings. Batch files containing the desired parameter settings can be prepared to configure devices quickly and easily.

1 INTRODUCTION

This manual provides all the necessary information for complete software configuration of various Datalogic families of second generation Hand-Held Devices (**HHD II**), including CCD guns and readers and laser scanners.

Your reader contains a built-in decoder and multi-standard interface.

It is designed for use in a wide variety of applications and environments including **commercial**, **office automation**, **retail**, and **light industrial** applications where large quantities of information need to be collected rapidly, easily and reliably.

It has several status indicator functions which are described in the next paragraph.

1.1 STATUS INDICATORS

Several status indicators are available depending on the type of reader: LEDs, Beeper, and Good Read Spot (for CCD Long Range readers only). They signal several operating conditions which are described in the tables below.

H = high tone

L = low tone

READER START-UP

Beeper ¹	Meaning
L L L L	Parameters loaded correctly
H H H H long tones	Parameter loading error, reading or writing error in the non volatile memory
H L H L	Hardware error in EEPROM
OFF	No beeper performed when illuminator line is kept high at power on.

READER CONFIGURATION

Beeper ¹	Meaning
H H H H	correct entry in Configuration mode
L	good read of a command
L L L	command read error
L H H H H	exit from Configuration mode

READER DATA ENTRY

Beeper ¹	LED	Good Read Spot	Meaning
one beep ²	ON	ON	correct read of a code in normal mode
	OFF	OFF	ready to read a code

¹ only the Beeper Intensity command can modify these signals.

² the data entry good read tone is user-configurable with all the Beeper commands in the Reading Parameters section.

2 INITIAL SETUP

2.1 INTERFACE SELECTION

Follow the procedure to configure the interface required by your application

- USB Interface
- RS232 Interface
- Wedge Interface
- Pen Emulation Interface
- IBM 46xx Interface

2.1.1 USB Interface Configuration

The USB interface is compatible with:

- Windows 98 (and later)
- Mac OS 8.0 (and later)
- IBM POS for Windows
- 4690 Operating System

The USB interface is compatible with:

Windows 98 (and later)	IBM POS for Windows
Mac OS 8.0 (and later)	4690 Operating System

START-UP

As with all USB devices, upon connection, the Host performs several checks by communicating with the USB device. During this phase the LED on the device blinks and normal operations are suspended. Two basic conditions must be met before the USB device is ready to read codes, the correct USB driver must be loaded and sufficient power must be supplied to the reader.

For all systems, the correct USB driver for the default USB-KBD interface is included in the Host Operating System and will either be loaded automatically or will be suggested by the O.S. and should therefore be selected from the dialog box (the first time only).

If the Host supplies sufficient power to the reader, the start-up phase ends correctly, the LED stops blinking and the reader emits the beep OK signal.

If the Host does not supply sufficient power to the reader, a dialog box will appear on the Host and the reader will be blocked (LED continues blinking). In this case, disconnect the USB device cable at the Host (LED stops blinking), connect and power-up an external supply to the USB device cable then reconnect the USB device cable to the Host and close the dialog box. The reader emits the beep OK signal. You can now read codes. At this point you can read the USB interface configuration code according to your application. Load drivers from the O.S. (if requested). When configuring the USB-COM interface, the relevant files and drivers must be installed from the USB Device Installation software which can be downloaded from the web site: <http://www.scanning.datalogic.com>.

The reader is ready.

First Start-Up

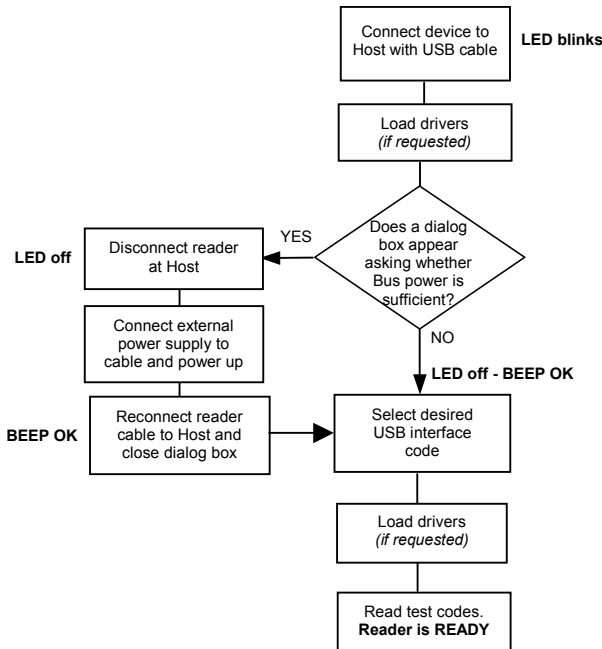

Successive start-ups will automatically recognize the previously loaded drivers. If external power is used, verify that external power is already supplied.

Successive Start-Ups

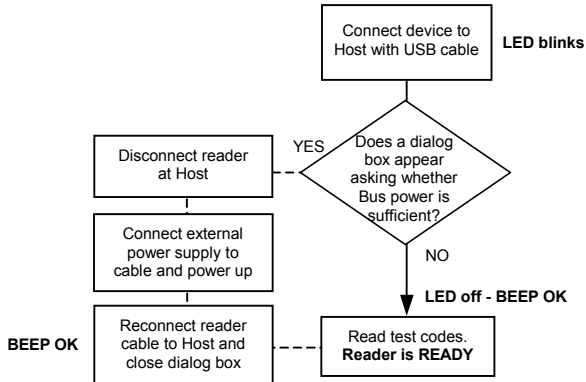

USB INTERFACE

USB-KBD



USB-KBD-ALT-MODE



USB-KBD-APPLE



USB-COM*



USB-IBM-Table Top



USB-IBM-Hand Held



* When configuring USB-COM, the relevant files and drivers must be installed from the USB Device Installation software which can be downloaded from the web site: (see <http://www.scanning.datalogic.com>).

2.1.2 RS232 Interface Selection

Read the restore default code, then read the interface selection code for your application:

RESTORE DEFAULT



RS232 INTERFACE

Standard



POS SYSTEMS

Nixdorf Mode A



Fujitsu



ICL Mode



For POS system default settings refer to par. 4.10.

2.1.3 Wedge Interface Selection

Read the restore default code, then read the interface selection code for your application:

RESTORE DEFAULT



WEDGE INTERFACE

IBM AT or PS/2 PCs



IBM XT



PC Notebook



IBM SURE1



IBM Terminal 3153



WEDGE INTERFACE (CONTINUED)

IBM Terminals 31xx, 32xx, 34xx, 37xx:

To select the interface for these IBM Terminals, read the correct KEY TRANSMISSION code. select the KEYBOARD TYPE if necessary (default = advanced keyboard).

KEY TRANSMISSION MODE

make-only keyboard



make-break keyboard

**KEYBOARD TYPE**

◆ advanced keyboard



typewriter keyboard

**ALT MODE**

The following interface selection allows barcodes sent to the PC to be interpreted correctly independently from the Keyboard Nationality used. **You do not need to make a Keyboard Nationality selection.**

(default = Num Lock Unchanged). **Make sure the Num Lock key on your keyboard is ON.**

IBM AT - ALT mode



PC Notebook - ALT mode



WEDGE INTERFACE (CONTINUED)

WYSE TERMINALS

ANSI Keyboard



PC Keyboard



ASCII Keyboard



VT220 style Keyboard



DIGITAL TERMINALS

VT2xx/VT3xx/VT4xx



APPLE

APPLE ADB Bus



2.1.4 Pen Emulation Interface Selection

Read the restore default code, then read the Pen Emulation interface selection code.

RESTORE DEFAULT



PEN EMULATION



2.1.5 IBM 46xx Interface Selection

(IBM Devices only)

PORT 9B

4501 Protocol



(typical)

1520 Protocol



PORT 5B

1520 Protocol



(typical)

4501 Protocol



3 CONFIGURATION

Once your reader is setup, you can change the default parameters to meet your application needs. Refer to chapter 2 for initial configuration in order to set the default values and select the interface for your application.

In this manual, the configuration parameters are divided into logical groups making it easy to find the desired function based on its reference group.

The first four groups are for Standard Interface parameter configuration, the fifth is only for IBM 46xx models:

- **USB**
- **RS232**
- **WEDGE**
- **PEN EMULATION**
- **IBM 46xx**

The following parameter groups are common to all interface applications:

DATA FORMAT parameters regard the messages sent to the Host system for all interfaces except Pen Emulation.

POWER SAVE manages overall current consumption in the reading device.

READING PARAMETERS control various operating modes and indicator status functioning.

DECODING PARAMETERS maintain correct barcode decoding in certain special reading conditions.

CODE SELECTION parameters allow configuration of a personalized mix of codes, code families and their options.

ADVANCED FORMATTING PARAMETERS allow code concatenation and advanced formatting of messages towards the Host. It cannot be used with Pen Emulation.

USB PARAMETERS

⊙	USB-COM	⊙
	Handshaking, Ack/Nack protocol, FIFO, Inter-character delay, Rx timeout, Serial trigger lock	
⊙	USB-KBD	⊙
	Keyboard nationality, FIFO, Inter-character delay, Inter-code delay, Control character emulation	
⊙	USB-IBM	⊙
	No parameter selection required.	

1. Read the **Enter Configuration** code ONCE, available at the top of each page.

2. Read configuration codes from the desired groups.



= Read the code and follow the procedure given



= Default value

3. Read the **Exit and Save Configuration** code ONCE, available at the top of each page.



HANDSHAKING

◆ disable



hardware (RTS/CTS)



software (XON/XOFF)



RTS always ON



See par. 4.1.1 for details.

ACK/NACK PROTOCOL

◆ disable



enable



See par. 4.1.2 for details.



FIFO

disable



◆ enable



See par. 4.1.3 for details.

INTER-CHARACTER DELAY

delay between characters transmitted to Host

**Read 2 numbers from the table where:**

00 = DELAY disabled

01-99 = DELAY from **1** to **99** milliseconds

◆ delay disabled



RX TIMEOUT

timeout control in reception from Host



Read 2 numbers from the table where:

00 = TIMEOUT disabled
01-99 = TIMEOUT from .1 to 9.9 seconds

◆ rx timeout 5 seconds

See par. 4.1.4 for details.

SERIAL TRIGGER LOCK

◆ disabled



enable and select characters



Read 2 characters from the Hex/Numeric table in the range 00-FE where:

- First Character enables device trigger
- Second Character inhibits device trigger until the first character is received again.



KEYBOARD NATIONALITY**Not Available for USB-KBD-ALT-MODE Interface**

This parameter default value is restored through the Interface Selection code and not Restore Default.

Belgian



English



French



German



Italian



Japanese



Spanish



Swedish



◆ USA





FIFO

disable



◆ enable



See par. 4.1.3 for details.

INTER-CHARACTER DELAY

delay between characters transmitted to Host



Read 2 numbers from the table where:

00 = DELAY disabled

01-99 = DELAY from **1** to **99** milliseconds

◆ delay disabled

INTER-CODE DELAY

delay between codes transmitted to Host



Read 2 numbers from the table where:

00 = DELAY disabled

01-99 = DELAY from **1** to **99** seconds

◆ delay disabled



CONTROL CHARACTER EMULATION

◆ CTRL+ Shift + Key



CTRL + Key



RS232 PARAMETERS

⊙	BAUD RATE	⊙
⊙	PARITY	⊙
⊙	DATA BITS	⊙
⊙	STOP BITS	⊙
⊙	HANDSHAKING	⊙
⊙	ACK/NACK PROTOCOL	⊙
⊙	FIFO	⊙
⊙	INTER-CHARACTER DELAY	⊙
⊙	RX TIMEOUT	⊙
⊙	SERIAL TRIGGER LOCK	⊙

1. Read the **Enter Configuration** code ONCE, available at the top of each page.

2. Read configuration codes from the desired groups.



= Read the code and follow the procedure given



= Default value

3. Read the **Exit and Save Configuration** code ONCE, available at the top of each page.



BAUD RATE

300 baud



600 baud



1200 baud



2400 baud



4800 baud



◆ 9600 baud



19200 baud



38400 baud





PARITY

◆ none



even parity



odd parity



DATA BITS

7 bits



◆ 8 bits



9 bits





STOP BITS

◆ 1 stop bit



2 stop bits



HANDSHAKING

◆ disable



hardware (RTS/CTS)



software (XON/XOFF)



RTS always ON



See par. 4.1.1 for details.



ACK/NACK PROTOCOL

◆ disable



enable



See par. 4.1.2 for details.

FIFO

disable



◆ enable



See par. 4.1.3 for details.



INTER-CHARACTER DELAY

delay between characters transmitted to Host



Read 2 numbers from the table where:

00 = DELAY disabled

01-99 = DELAY from 1 to 99 milliseconds

◆ delay disabled

RX TIMEOUT

timeout control in reception from Host



Read 2 numbers from the table where:

00 = TIMEOUT disabled

01-99 = TIMEOUT from .1 to 9.9 seconds

◆ rx timeout 5 seconds

See par. 4.1.4 for details.



SERIAL TRIGGER LOCK

◆ disabled



enable and select characters



Read 2 characters from the Hex/Numeric table in the range 00-FE where:

- First Character enables device trigger
- Second Character inhibits device trigger until the first character is received again.

WEDGE PARAMETERS

⊙	KEYBOARD NATIONALITY	⊙
⊙	CAPS LOCK	⊙
⊙	CAPS LOCK AUTO-RECOGNITION	⊙
⊙	NUM LOCK	⊙
⊙	INTER-CHARACTER DELAY	⊙
⊙	INTER-CODE DELAY	⊙
⊙	CONTROL CHARACTER EMULATION	⊙
⊙	KEYBOARD SETTING	⊙

1. Read the **Enter Configuration** code ONCE, available at the top of each page.

2. Read configuration codes from the desired groups.



= Read the code and follow the procedure given



= Default value

3. Read the **Exit and Save Configuration** code ONCE, available at the top of each page.

**WEDGE*****KEYBOARD NATIONALITY***

This parameter default value is restored through the Interface Selection code and not Restore Default.

Belgian



English



French



German



Italian



Spanish



Swedish



◆ USA



The Japanese Keyboard Nationality selection is valid only for IBM AT compatible PCs.

Japanese





CAPS LOCK

◆ caps lock OFF



caps lock ON



Select the appropriate code to match your keyboard caps lock status.

Note: Caps lock manual configuration is ignored when Caps Lock Auto-Recognition is enabled.

For **PC Notebook** interface selections, the caps lock status is automatically recognized, therefore this command is not necessary.

CAPS LOCK AUTO-RECOGNITION (IBM AT COMPATIBLE ONLY)

disable



◆ enable



**WEDGE**

NUM LOCK

toggle num lock



◆ num lock unchanged



This selection is used together with the Alt Mode interface selection for AT or Notebook PCs.

It changes the way the Alt Mode procedure is executed, therefore it should be set as follows:

- if your keyboard Num Lock is normally on use **num lock unchanged**
- if your keyboard Num Lock is normally off use **toggle num lock**

In this way the device will execute the Alt Mode procedure correctly for your application.

INTER-CHARACTER DELAY

delay between characters transmitted to Host

**Read 2 numbers from the table where:**

00 = DELAY disabled

01-99 = DELAY from **1** to **99** milliseconds

◆ delay disabled



INTER-CODE DELAY



delay between codes transmitted to Host



Read 2 numbers from the table where:

- 00 = DELAY disabled
- 01-99 = DELAY from 1 to 99 seconds

◆ delay disabled

CONTROL CHARACTER EMULATION

◆ CTRL+ Shift + Key



CTRL + Key





WEDGE

KEYBOARD SETTING

ALPHANUMERIC KEYBOARD SETTING

The reader can be used with terminals or PCs with various keyboard types and nationalities through a simple keyboard setting procedure.

The type of computer or terminal must be selected before activating the keyboard setting command.

Keyboard setting consists of communicating to the reader how to send data corresponding to the keyboard used in the application. The keys must be set in a specific order.

Press and release a key to set it.

Some characters may require more than one key pressed simultaneously during normal use (refer to the manual of your PC or terminal for keyboard use). The exact sequence must be indicated to the reader in this case pressing and releasing the different keys.

Example:

If one has to press the "Shift" and "4" keys simultaneously on the keyboard to transmit the character "\$" to the video, to set the "\$", press and release "Shift" then press and release "4".

Each pressed and released key must generate an acoustic signal on the reader, otherwise repress the key. Never press more than one key at the same time, even if this corresponds to the normal use of your keyboard.

Press "Backspace" to correct a wrong key entry. In this case the reader emits 2 beeps.

Note: "CAPS LOCK" and "NUM LOCK" must be off before starting the keyboard setting procedure. "SHIFT" must be repressed for each character and cannot be substituted by "CAPS LOCK".



setting the alphanumeric keyboard



Read the code above.

Press the keys shown in the following table according to their numerical order:



Some ASCII characters may be missing as this depends on the type of keyboard: these are generally particular characters relative to the various national symbolologies. In this case:

- **The first 4 characters (Shift, Alt, Ctrl, and Backspace) can only be substituted with keys not used, or substituted with each other.**
- characters can be substituted with other single symbols (e.g. "SPACE") even if not included in the barcode set used.
- characters can be substituted with others corresponding to your keyboard.

The reader signals the end of the procedure with 2 beeps indicating the keys have been registered.

01 : Shift		
02 : Alt		
03 : Ctrl		
04 : Backspace		
05 : SPACE	28 : 7	51 : N
06 : !	29 : 8	52 : O
07 : "	30 : 9	53 : P
08 : #	31 : :	54 : Q
09 : \$	32 : ;	55 : R
10 : %	33 : <	56 : S
11 : &	34 : =	57 : T
12 : '	35 : >	58 : U
13 : (36 : ?	59 : V
14 :)	37 : @	60 : W
15 : *	38 : A	61 : X
16 : +	39 : B	62 : Y
17 : ,	40 : C	63 : Z
18 : -	41 : D	64 : [
19 : .	42 : E	65 : \
20 : /	43 : F	66 :]
21 : 0	44 : G	67 : ^
22 : 1	45 : H	68 : _ (underscore)
23 : 2	46 : I	69 : `
24 : 3	47 : J	70 : {
25 : 4	48 : K	71 :
26 : 5	49 : L	72 : }
27 : 6	50 : M	73 : ~
		74 : DEL

PEN EMULATION

⊙	OPERATING MODE	⊙
⊙	MINIMUM OUTPUT PULSE	⊙
⊙	CONVERSION TO CODE 39	⊙
⊙	OVERFLOW	⊙
⊙	OUTPUT LEVEL	⊙
⊙	IDLE LEVEL	⊙
⊙	INTER-BLOCK DELAY	⊙

1. Read the **Enter Configuration** code ONCE, available at the top of each page.

2. Read configuration codes from the desired groups.

◆ = Default value

3. Read the **Exit and Save Configuration** code ONCE, available at the top of each page.

PEN EMULATION

The operating mode parameters are complete commands and do not require reading the Enter and Exit configuration codes.

OPERATING MODE

◆ interpret mode



Interprets commands without sending them to the decoder.

transparent mode



Sends commands to the decoder without interpreting them.



MINIMUM OUTPUT PULSE

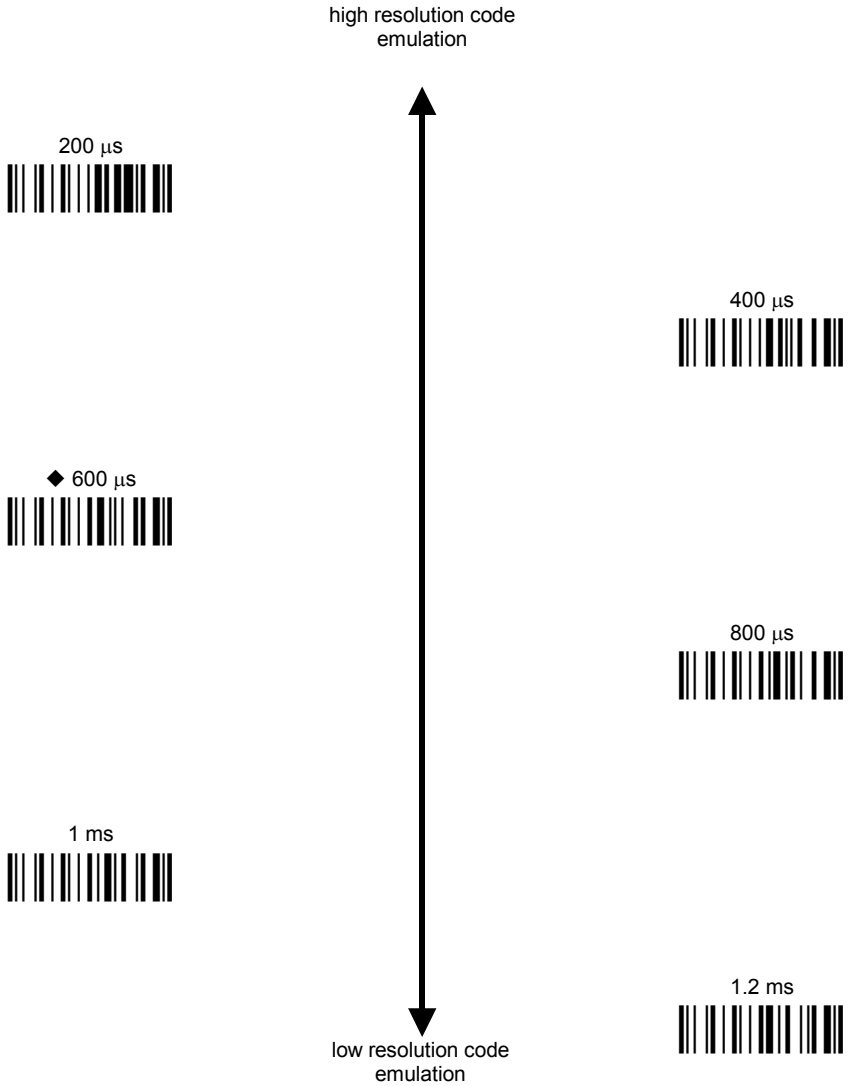

See par. 4.2.1 for details.



PEN EMULATION

CONVERSION TO CODE 39

- ▶ disable conversion to Code 39



Transmits codes in their original format.

- enable conversion to Code 39



Converts codes read into Code 39 format.

See par. 4.2.2 for details.

OVERFLOW

narrow



◆ medium



wide



See par. 4.2.3 for details.



OUTPUT LEVEL

◆ normal
(white = logic level 0)



inverted
(white = logic level 1)



See par. 4.2.4 for details.

IDLE LEVEL

◆ normal
(black level)



inverted
(white level)



See par. 4.2.4 for details.



INTER-BLOCK DELAY

delay between character blocks transmitted to Host



Read 2 numbers from the table where:

00 = DELAY disabled

01-99 = DELAY from .1 to **9.9** seconds

◆ delay disabled

See par. 4.2.5 for details.

IBM 46XX

⊙ *IBM DATA FORMATTING* ⊙

- 1.** Read the **Enter Configuration** code ONCE, available at the top of each page.
- 2.** Read configuration codes from the desired groups.
 - ◆ = Default value
- 3.** Read the **Exit and Save Configuration** code ONCE, available at the top of each page.



IBM DATA FORMATTING

conversion to Code 39



◆ IBM Standard



mixed IBM Standard + Code 39



See par. 4.3.1 for details.

DATA FORMAT

NOT FOR PEN INTERFACES

⊙	CODE IDENTIFIER	⊙
⊙	CUSTOM CODE IDENTIFIER	⊙
⊙	HEADER	⊙
⊙	TERMINATOR	⊙
⊙	FIELD ADJUSTMENT	⊙
⊙	FIELD ADJ. CHARACTER	⊙
⊙	CODE LENGTH TX	⊙
⊙	CHARACTER REPLACEMENT	⊙

1. Read the **Enter Configuration** code ONCE, available at the top of each page.

2. Read configuration codes from the desired groups.



= Read the code and follow the procedure given



= Default value

3. Read the **Exit and Save Configuration** code ONCE, available at the top of each page.

DATA FORMAT

CODE IDENTIFIER TABLE			
CODE	AIM STANDARD	DATALOGIC STANDARD	Custom
2/5 interleaved] I y	N	
2/5 industrial] X y	P	
2/5 normal 5 bars] S y	O	
2/5 matrix 3 bars] X y	Q	
EAN 8] E 4	A	
EAN 13] E 0	B	
UPC A] X y	C	
UPC E] X y	D	
EAN 8 with 2 ADD ON] E 5	J	
EAN 8 with 5 ADD ON] E 6	K	
EAN 13 with 2 ADD ON] E 1	L	
EAN 13 with 5 ADD ON] E 2	M	
UPC A with 2 ADD ON] X y	F	
UPC A with 5 ADD ON] X y	G	
UPC E with 2 ADD ON] X y	H	
UPC E with 5 ADD ON] X y	I	
Code 39] A y	V	
Code 39 Full ASCII] A y	W	
CODABAR] F y	R	
ABC CODABAR] X y	S	
Code 128] C y	T	
EAN 128] C y	k	
ISBT 128] C4	f	
Code 93] G y	U	
CIP/39] X y	Y	
CIP/HR] X y	e	
Code 32] X y	X	
MSI] M y	Z	
Plessey Standard] P 0	a	
Plessey Anker] P 1	o	
Telepen] X 0	d	
Delta IBM] X 0	c	
Code 11] H y	b	
Code 16K] K 0	p	
Code 49] T y	q	
RSS Expanded Linear and Stacked] e 0	t	
RSS Limited] e 0	v	
RSS 14 Linear and Stacked] e 0	u	

DATA FORMAT

- AIM standard identifiers are not defined for all codes: the X identifier is assigned to the code for which the standard is not defined. The y value depends on the selected options (check digit tested or not, check digit tx or not, etc.).
- When customizing the Datalogic Standard code identifiers, 1 or 2 identifier characters can be defined for each code type. If only 1 identifier character is required, the second character must be selected as **FF** (disabled).
- The code identifier can be singly disabled for any code by simply selecting **FF** as the first identifier character.
- Write in the Custom character identifiers in the table above for your records.



DATA FORMAT



CODE IDENTIFIER

◆ disable



Datalogic standard



AIM standard



custom







CUSTOM CODE IDENTIFIER

define custom code identifier(s)



- ① Read the above code.
(Code Identifiers default to Datalogic standard, see table on previous page).
- ② Select the code type from the code table in Appendix B for the identifier you want to change.
- ③ You can define 1 or 2 identifier characters for each code type. If only 1 identifier character is required, the second character must be selected as **FF** (disabled). Read the hexadecimal value corresponding to the character(s) you want to define as identifiers for the code selected in step ②: valid characters are in the range **00-FD**.

Example: To define Code 39 Code Identifier = @

Read  +  + **40** + **FF**



HEADER

no header



one character header



two character header



three character header



four character header



five character header



six character header



seven character header



eight character header



After selecting **one** of the desired Header codes, read the character(s) from the HEX table. Valid characters are in the range **00-FE**.

Example:

four character header

+ 41 + 42 + 43 + 44 = Header **ABCD**

For more details see par. 4.4.1.



TERMINATOR

no terminator



one character terminator



two character terminator



three character terminator



four character terminator



five character terminator



six character terminator



seven character terminator



eight character terminator



After selecting **one** of the desired Header codes, read the character(s) from the HEX table. Valid characters are in the range **00-FE**.

Example:

two character terminator



+ 0D + 0A = Terminator CR LF

For more details see par. 4.4.1.

**FIELD ADJUSTMENT**

◆ disable field adjustment



Field adjustment allows a number of characters n , to be added to or subtracted from the barcode read. The adjustment can be different for each enabled code type. To define the field adjustment:

- ① Read the enable field adjustment code:

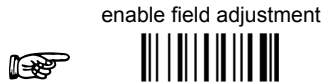

- ② Select the code type from the Code Identifier Table in Appendix B.
- ③ Select the type of adjustment to perform:

right addition



left addition



right deletion



left deletion





- ④ Read a number in the range **01 - 32** from the Hex/Numeric Table to define how many characters to add or delete:

Conditions:

- Adjustment is only performed on the barcode data, the Code Identifier and Code Length Transmission fields are not modified by the field adjustment parameter.
- If the field setting would subtract more characters than exist in the barcode, the subtraction will take place only to code length 0.
- You can set up to a maximum of 10 different field adjustments on the same barcode family or on different barcode families.

Example: To add 4 characters to the right of Standard Code 39 Codes:

Read  +  +  + 04



FIELD ADJUSTMENT CHARACTER

- ① Read the field adjustment character code:

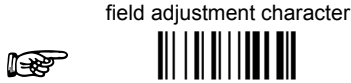

- ② Read the hexadecimal value corresponding to the character you want to use for field adjustment. Valid characters are in the range **00-FE**.

Example:

To define the field adjustment character = **A**:



CODE LENGTH TX

- ◆ code length not transmitted



code length transmitted in variable-digit format



code length transmitted in fixed 4-digit format



The code length is transmitted in the message after the Headers and Code Identifier characters. The code length is calculated after performing any field adjustment operations.



CHARACTER REPLACEMENT

◆ disable character replacement



This parameter allows up to three characters to be replaced from the barcode read. These substitutions are stored in memory. To define each character replacement:

- ① Read one of the following character replacement codes:



first character replacement



second character replacement



third character replacement



- ② From the Code Identifier Table in Appendix B, read the Code Identifier for the desired code family.
0 = character replacement will be effective for all code families.
- ③ From the Hex/Numeric Table read two characters corresponding to the Hex value (**00-FE**) which identifies the character to be replaced.
- ④ From the Hex/Numeric Table read two characters corresponding to the Hex value (**00-FE**) which identifies the new character to replace.
FF = the character to be replaced will be substituted with no character, that is, it will be removed from the code.

**Example:**

The following strings define:

1. *First Character Replacement:* substitution in *Code 39 barcodes* of all occurrences of the **0** character with the **1** character.
2. *Second Character Replacement:* substitution in *Code 39 barcodes* of all occurrences of the **A** character with the **B** character.

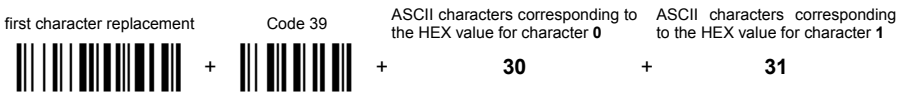

For Code 39 codes containing the string "**0123**", the contents transmitted will be "**1123**".

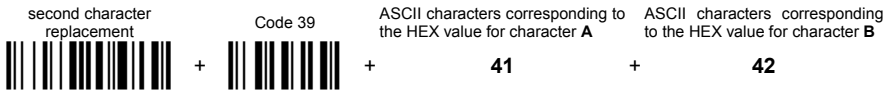

For Code 39 codes containing the string "**ABCD**", the contents transmitted will be "**BBCD**".

POWER SAVE

⊙	SCAN RATE	⊙
⊙	SLEEP STATE/USB SUSPEND	⊙
⊙	ENTER SLEEP TIMEOUT	⊙
⊙	STANDBY	⊙

1. Read the **Enter Configuration** code ONCE, available at the top of each page.

2. Read configuration codes from the desired groups.



= Read the code and follow the procedure given



= Default value

3. Read the **Exit and Save Configuration** code ONCE, available at the top of each page.



POWER SAVE



SCAN RATE

CCD Readers ONLY

quarter



half



◆ maximum



A lower scan rate reduces power consumption but can lengthen reading response time.

SLEEP STATE/USB SUSPEND

ONLY Devices with Button/Trigger

◆ disable



enable



See par. 4.5.1 for details.



POWER SAVE

ENTER SLEEP TIMEOUT

ONLY Devices with Button/Trigger



enter sleep timeout



Read 2 numbers in the range 00-99:

00 = Enter Sleep state immediately

01-99 = corresponds to a max. 9.9 sec. delay before entering the Sleep state.

See par. 4.5.2 for details.

STANDBY

ONLY for CCD Devices

◆ disable



optimize for reading speed

enable



optimize for low power consumption

See par. 4.5.3 for details.

READING PARAMETERS

⊙	<i>HAND-HELD OPERATION</i>	⊙
⊙	<i>STAND OPERATION</i>	⊙
⊙	<i>TRIGGER SIGNAL</i>	⊙
⊙	<i>TRIGGER-OFF TIMEOUT</i>	⊙
⊙	<i>FLASH MODE</i>	⊙
⊙	<i>READS PER CYCLE</i>	⊙
⊙	<i>SAFETY TIME</i>	⊙
⊙	<i>BEEPER INTENSITY</i>	⊙
⊙	<i>BEEPER TONE</i>	⊙
⊙	<i>BEEPER TYPE</i>	⊙
⊙	<i>BEEPER LENGTH</i>	⊙
⊙	<i>GOOD READ SPOT DURATION</i>	⊙
⊙	<i>STAND RECOGNITION BEEP</i>	⊙
⊙	<i>AUTOMATIC OPERATION</i>	⊙
⊙	<i>AIMING LIGHT</i>	⊙
⊙	<i>AIMING SYSTEM</i>	⊙

1. Read the **Enter Configuration** code ONCE, available at the top of each page.

2. Read configuration codes from the desired groups.



= Read the code and follow the procedure given



= Default value

3. Read the **Exit and Save Configuration** code ONCE, available at the top of each page.



READING PARAMETERS

HAND-HELD OPERATION

◆ hardware trigger



always on



* hardware trigger ready



□ software trigger



♣ automatic



◆ = default value for devices with trigger

□ = default value for devices without trigger

* = only for CCD readers with trigger

♣ = only for CCD readers

For *Automatic* Hand-Held or Stand Operation, the Safety Time parameter is forced to no code consecutive reading (00).

See par. 4.6.1 for details

STAND OPERATION

ONLY Devices with Stand Recognition Beep

hardware trigger



always on



software trigger



◆ ♣ automatic



See par. 4.6.1 for details



HARDWARE TRIGGER SIGNAL**ONLY Devices with Button/Trigger**

◆ trigger active level



trigger active pulse



See par. 4.6.2 for details

TRIGGER-OFF TIMEOUT**ONLY Devices with Button/Trigger**

trigger-off timeout

**Read 2 numbers in the range 00-99:**

00 = disables the trigger-off timeout

01-99 = corresponds to a max. 99-sec. delay after the trigger press to allow the reader to turn off automatically.

◆ trigger-off timeout disabled

See par. 4.6.3 for details.



FLASH MODE



"FLASH" ON duration



"FLASH" OFF duration



Read 2 numbers in the range 01-99:

01 to 99 = from .1 to 9.9 seconds.

◆ Flash-ON = 1 sec. Flash-OFF = 0.6 sec

READS PER CYCLE

◆ one read per cycle



multiple reads per cycle



See par. 4.6.4 for details.



READING PARAMETERS

SAFETY TIME



safety time



Limits same code consecutive reading.

Read 2 numbers in the range 00-99:

00 = no same code consecutive reading until reader is removed (no decoding) for at least 400 ms.

01-99 = timeout from .1 to 9.9 seconds before a consecutive read on same code.

◆ safety time = 0.5 sec

See par. 4.6.5 for details.

BEEPER INTENSITY

beeper off *



low intensity



medium intensity



◆ high intensity



* This sets the beeper OFF for data entry, while for all other beeper signals it has the meaning "very low intensity". The Beeper Intensity parameter is effective for all operating conditions described in par. 1.1.



READING PARAMETERS

BEEPER TONE

tone 1



◆ tone 2



tone 3



tone 4



BEEPER TYPE

◆ monotone



bitonal



BEEPER LENGTH

long



◆ short





READING PARAMETERS

GOOD READ SPOT DURATION

CCD Long Range Readers ONLY

disable



short



◆ medium



long



STAND RECOGNITION BEEP

ONLY Readers with Stand Recognition

disable



◆ enable





READING PARAMETERS



AUTOMATIC OPERATION AIMING LIGHT

CCD Long Range Readers ONLY

disable



◆ enable



See par. 4.6.6 for details.

AIMING SYSTEM

Laser Readers ONLY

◆ disable



300 ms



500 ms



1 sec



See par. 4.6.7 for details.

DECODING PARAMETERS

⊙	INK SPREAD	⊙
⊙	OVERFLOW CONTROL	⊙
⊙	INTERDIGIT CONTROL	⊙
⊙	DECODING SAFETY	⊙
⊙	PUZZLE SOLVER™	⊙



CAUTION

Before changing these parameter values read the descriptions in par. 4.7.

- 1.** Read the **Enter Configuration** code ONCE, available at the top of each page.
- 2.** Read configuration codes from the desired groups.
◆ = Default value
- 3.** Read the **Exit and Save Configuration** code ONCE, available at the top of each page.



INK SPREAD

disable



◆ enable



See par. 4.7.1 for details.

OVERFLOW CONTROL

disable



◆ enable



See par. 4.7.2 for details.



DECODING PARAMETERS

INTERDIGIT CONTROL

disable



◆ enable



See par. 4.7.3 for details.

DECODING SAFETY

◆ one read



(decoding safety disabled)

two reads



three reads



four reads



Required number of good reads before accepting code.



PUZZLE SOLVER™

◆ disable



enable



In the case of damaged or poorly printed codes, this parameter allows reading multiple parts of the single code to reconstruct it.

To read codes using this technology, simply move the reader over the code so that each line of the code is scanned.

Conditions:

- This parameter is only valid for the following codes:

EAN 8 without Add-on	EAN 13 without Add-on	UPC A without Add-on
Code 128	Code 39	

- For Code 39, Check digit control without transmission is forced.
- PuzzleSolver™ is disabled when code ISBT 128 is enabled.

CODE SELECTION

⊙	EAN/UPC FAMILY	⊙
⊙	2/5 FAMILY	⊙
⊙	CODE 39 FAMILY	⊙
⊙	CODE 128 FAMILY	⊙
⊙	CODABAR FAMILY	⊙
⊙	CODE 93	⊙
⊙	MSI	⊙
⊙	PLESSEY	⊙
⊙	TELEPEN	⊙
⊙	DELTA IBM	⊙
⊙	CODE 11	⊙
⊙	CODE 16K	⊙
⊙	CODE 49	⊙
⊙	RSS CODES	⊙

1. Read the **Enter Configuration** code ONCE, available at the top of each page.

2. Read configuration codes from the desired groups.



= Read the code and follow the procedure given



= Default value

3. Read the **Exit and Save Configuration** code ONCE, available at the top of each page.



CODE SELECTION

DISABLES ALL CODE FAMILIES



NOTE

The reader allows up to 5 code selections. This does not limit the number of CODES enabled to 5, as it depends on the code family.

**SINGLE
SELECTIONS =**

- ONE combination code from the EAN family
- ONE code from the 2/5 family

Example

5 code selections:

1. 2/5 Interleaved
2. 2/5 Industrial
3. Code 128 + EAN 128
4. Code 39 Full ASCII + Code 32
5. UPC A/UPC E

In this section all **SINGLE** code selections are **underlined and in bold.**



CODE SELECTION

EAN/UPC FAMILY

disable the family



- ① Read the desired family code

Note:

Since the EAN/UPC without ADD ON code selection is enabled by default, to correctly enable another selection, first disable the family.

EAN 8/EAN 13/UPC A/UPC E with and without ADD ON



WITHOUT ADD ON

◆ EAN 8/EAN 13/UPC A/UPC E



EAN 8/EAN 13



UPC A/UPC E





CODE SELECTION

WITH ADD ON 2 AND 5

EAN 8/EAN 13/UPC A/UPC E



EAN 8/EAN 13



UPC A/UPC E



WITH ADD ON 2 ONLY

EAN 8/EAN 13



UPC A/UPC E



WITH ADD ON 5 ONLY

EAN 8/EAN 13



UPC A/UPC E





CODE SELECTION

EAN/UPC CHECK DIGIT TX SELECTIONS

For each code type in this family you can choose to transmit the check digit or not

CHECK DIGIT TRANSMISSION

◆ EAN 8



◆ EAN 13



◆ UPC A



◆ UPC E



NO CHECK DIGIT TRANSMISSION

EAN 8



EAN 13



UPC A



UPC E





CODE SELECTION

CONVERSION OPTIONS

UPC E to UPC A conversion



UPC E to EAN 13 conversion



UPC A to EAN 13 conversion



EAN 8 to EAN 13 conversion



Enable only ISBN conversion



Enable only ISSN conversion



Enable both ISBN and ISSN conversion



Disable both ISBN and ISSN conversion



**CODE SELECTION****2/5 FAMILY**

disables the family



① Read the desired family code

◆ **Interleaved 2/5**◆ **Normal 2/5 (5 Bars)**◆ **Industrial 2/5 (IATA)**◆ **Matrix 2/5 (3 Bars)**

The pharmaceutical code below is part of the 2/5 family but has no check digit or code length selections.

◆ **Code CIP/HR**

French pharmaceutical code

② Read a check digit selection

CHECK DIGIT TABLE

no check digit control



◆ check digit control and transmission



check digit control without transmission



③ Read 4 numbers for the code length where:

- **First 2 digits** = minimum code length.
- **Second 2 digits** = maximum code length.

The maximum code length is **99** characters.

The minimum code length must always be less than or equal to the maximum.

Examples:

0199 = variable from 1 to 99 digits in the code.

1010 = 10 digit code length only.



CODE SELECTION

CODE 39 FAMILY

disables the family



① Read the desired family code

② Read a check digit selection

CHECK DIGIT TABLE

◆ **Standard Code 39**



◆ no check digit control



◆ **Full ASCII Code 39**



check digit control
and transmission



check digit control
without transmission





CODE SELECTION

The pharmaceutical codes below are part of the Code 39 family but have no check digit selections.

Code CIP39



French pharmaceutical code

Code 32



Italian pharmaceutical code

CODE LENGTH (optional)

The code length selection is valid for the entire Code 39 family

Read the code + 4 numbers for the code length where:

First 2 digits = minimum code length.

Second 2 digits = maximum code length.

set code length



The maximum code length is **99** characters.

The minimum code length must always be less than or equal to the maximum.

Examples: **0199** = variable from 1 to 99 digits in the code. **1010** = 10 digit code length only.



CODE SELECTION

CODE 128 FAMILY

disables the family



- ① Read the desired family code

◆ Code 128



control without transmission
of check digit

EAN 128



control without transmission
of check digit

Transmit GS Before Code

Code EAN 128 uses the ASCII <GS> character to separate a variable length code field from the next code field. This character can also be transmitted before the code.

◆ disable



enable



If the <GS> character has been modified in the Character Replacement parameter, the new character is affected by this command.



CODE SELECTION

ISBT 128



Enabling ISBT 128 automatically disables Puzzle Solver™.

CODE LENGTH (optional)

The code length selection is valid for the entire Code 128 family.

Read the code + 4 numbers for the code length where:

set code length

First 2 digits = minimum code length



Second 2 digits = maximum code length

The maximum code length is 99 characters. The minimum code length must always be less than or equal to the maximum.

Examples: **0199** = variable from 1 to 99 digits in the code. **1010** = 10 digit code length only.

The length is calculated on the output string.

CODE 93

◆ disables the code



Code 93



control without transmission
of check digit



CODE SELECTION

CODABAR FAMILY

◆ disables the family



① Read the desired equality control code

② Read a start/stop transmission selection

Standard Codabar



no start/stop character equality control

START/STOP CHARACTER TRANSMISSION

no transmission



Standard Codabar



start/stop character equality control

transmission



The Codabar ABC code below uses a fixed start/stop character transmission selection.

Codabar ABC



no start/stop character equality control but transmission.



CODE SELECTION

Codabar ABC Forced Concatenation

enable Codabar ABC with forced concatenation



non start/stop character equality control but transmission

CODE LENGTH (optional)

The code length selection is valid for the entire Codabar family

Read the code + 4 numbers for the code length where:

First 2 digits = minimum code length.

Second 2 digits = maximum code length.

set code length



The maximum code length is **99** characters.

The minimum code length must always be less than or equal to the maximum.

Examples: **0199** = variable from 1 to 99 digits in the code. **1010** = 10 digit code length only.

START/STOP CHARACTER CASE IN TRANSMISSION

The start/stop character case selections below are valid for the entire Codabar family:

transmit start/stop characters in lower case



transmit start/stop characters in upper case





CODE SELECTION

MSI

◆ disables the family



Enable the code by selecting one of the check digit selections.

no check digit control



MOD10 check digit control
no check digit transmission



MOD10 check digit control
check digit transmission



MOD11 - MOD10 check digit control
no check digit transmission



MOD11 - MOD10 check digit control
check digit transmission



MOD10 - MOD10 check digit control
no check digit transmission



MOD10 - MOD10 check digit control
check digit transmission





CODE SELECTION

PLESSEY

◆ disables the family



Enable the code by selecting one of the check digit selections.

Standard Plessey

no check digit control



check digit control
check digit transmitted



check digit control
check digit not transmitted



Anker Plessey

no check digit control



check digit control
check digit transmitted



check digit control
check digit not transmitted





CODE SELECTION

TELEPEN

◆ disables the family



Enable the code by selecting one of the check digit selections.

Numeric Telepen

no check digit control



check digit control
check digit transmitted



check digit control
check digit not transmitted



Alphanumeric Telepen

no check digit control



check digit control
check digit transmitted



check digit control
check digit not transmitted





CODE SELECTION



DELTA IBM

◆ disables the family



Enable the code by selecting one of the check digit selections.

no check digit control



Type 1 check digit control



Type 2 check digit control





CODE SELECTION

CODE 11

◆ disables the family



Enable the code by selecting one of the check digit selections.

no check digit control



Type C check digit control
check digit transmitted



Type C check digit control
check digit not transmitted



Type K check digit control
check digit transmitted



Type K check digit control
check digit not transmitted



Type C and Type K
check digit control
check digits transmitted



Type C and Type K
check digit control
check digits not transmitted





CODE SELECTION

CODE 16K

◆ disables the code



Code 16K



To read stacked codes, simply move the reader over the code so that each line of the code is scanned.

CODE 49

◆ disables the code



Code 49



To read stacked codes, simply move the reader over the code so that each line of the code is scanned.



CODE SELECTION

RSS CODES

◆ disables the family



DISABLE CODE

disable RSS Expanded Linear and Stacked



disable RSS Limited



disable RSS 14 Linear and Stacked



ENABLE CODE

enable RSS Expanded Linear and Stacked



enable RSS Limited



enable RSS 14 Linear and Stacked



To read the stacked version of these codes, simply move the reader over the code so that each line of the code is scanned.

ADVANCED FORMATTING

- ⊙ **CONCATENATION** ⊙
- ⊙ **ADVANCED FORMATTING** ⊙



NOTE

Please follow the setup procedure carefully for these parameters.

- 1.** Read the **Enter Configuration** code ONCE, available at the top of page .
- 2.** Read configuration codes precisely following the numbered procedure given.
 -  = Read the code and follow the procedure given
 - ◆ = Default value
- 3.** Read the **Exit and Save Configuration** code ONCE, available at the top of page.



CONCATENATION

◆ disable



enable



Permits the concatenation of two codes defined by code type and length. It is possible to set a timeout for the second code reading and to define code transmission if the timeout expires.

The order of transmission is CODE 1-CODE 2.

Define Concatenation

1

Code 1

code ID



Read the code type from the Code Identifier Table beginning in Appendix B.

code length



Read a number in the range **01-99** from the Hex/Numeric Table.

ADVANCED FORMATTING



2

Code 2

code ID



Read the code type from the Code Identifier Table beginning in Appendix B.

code length



Read a number in the range **01-99** from the Hex/Numeric Table.

3

Concatenation Result Code ID

use code 1 ID



use code 2 ID



Since you can concatenate codes from different families, you must select the Code ID character of the resulting code. The Code ID character will be sent in the output message only if it is enabled according to the Code Identifier selection (Datalogic, AIM, or Custom).

4

Concatenation Timeout

timeout



Read two numbers in the range **00 to 99**

00= no timeout

01-99 = timeout from 1 to 99 seconds

Define the timeout, which determines the valid waiting period between the two codes, in order to accept concatenation. If the timeout expires, the resulting action will be based on the following selection.

ADVANCED FORMATTING



5

Transmission after Timeout

no code transmitted
after timeout



only code 1 transmitted
(if read) after timeout



only code 2 transmitted
(if read) after timeout



either code 1 or code 2 transmitted
after timeout



ADVANCED FORMATTING

ADVANCED FORMATTING

Advanced formatting has been designed to offer you complete flexibility in changing the format of barcode data **before** transmitting it to the host system. This formatting will be performed when the barcode data meets certain criteria which you will define in the following procedure.

Up to 4 advanced code management formats can be defined and saved in memory. For each format you must complete the entire configuration procedure:

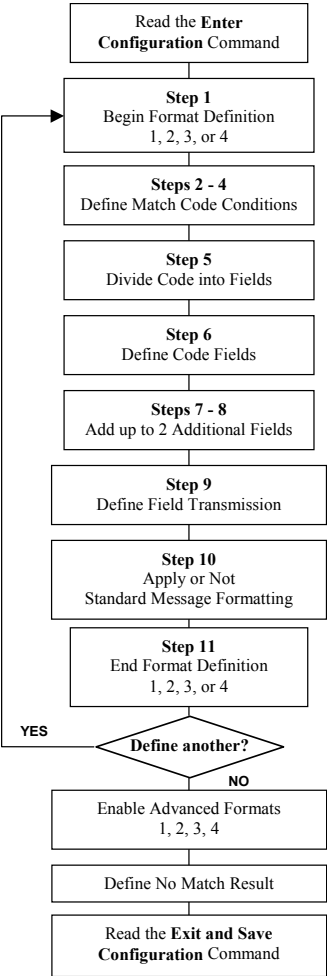

**ADVANCED FORMATTING**

1

Begin Format Definition

begin Format 1 definition



begin Format 2 definition



begin Format 3 definition



begin Format 4 definition



2

Match Code Type

match code type

Read the above code + the code type to match from the [Code Identifier Table](#) in Appendix B.**OR**

any code type



3

Match Code Length

match code length

Read the above code + two numbers in the range **01 to 99** for the exact code length.**OR**

any code length



ADVANCED FORMATTING



4

Match with Predefined Characters

no match



OR

match with 1 character



match with a 2-character string



match with a 3-character string



match with a 4-character string



After selecting the predefined match code, read the character(s) from the HEX table. Range of characters = **01-FE**.

Example:

Match code with the 2-character predefined string = "@@".

Read  + 40 + 40

AND

position of first character in predefined string



Read the above code + two numbers in the range **01** to **99** representing the character position in the code where the first character of the predefined string must be found.

Read **00** if the match string can be found in any character position.

ADVANCED FORMATTING



5

Divide Code into Fields



divide code into fields



Read one number in the range 1 to 5 to divide the code into fields.

6

Define Code Fields

define code fields

Each code field length can be set by either:

- a) defining a field separator character to be found in the code itself. In this case you can choose to **discard** the code separator character or **include** it as the last character of the field.

OR BY

- b) defining a match character to be found consecutively repeated in the code itself. In this case the field ends with the first character that does not match.

OR BY

- c) specifying a specific character length up to the maximum of 99 characters.

OR BY

- d) selecting the last field as variable length (if any).

You must define the same number of fields as selected in step 5, including fields that will not be transmitted.

ADVANCED FORMATTING



DEFINE FIELD 1 BY: EITHER

a)

field separator

Read the field separator character from the HEX table. Range of characters = **01-FE**.

discard separator



include separator



OR

b)

match character

Read the match character from the HEX table. Range of characters = **01-FE**.

OR

c)

field length

Read two numbers in the range **01** to **99** to define the field length.

OR

d)

this is the last field (variable length)



AND

Field 1 Terminators

no field terminators



1 field terminator



2 field terminators



Read the field terminator character(s) from the HEX table.

Valid range of characters for all readers = **01-FE**.For readers using Wedge interface, all values from **9C** to **FE** send the Space character.

ADVANCED FORMATTING



DEFINE FIELD 2 BY: EITHER

a)

field separator

Read the field separator character from the HEX table. Range of characters = **01-FE**.

discard separator



include separator



OR

b)

match character

Read the match character from the HEX table. Range of characters = **01-FE**.

OR

c)

field length

Read two numbers in the range **01** to **99** to define the field length.

OR

d)

this is the last field (variable length)



AND

Field 2 Terminators

no field terminators



1 field terminator



2 field terminators



Read the field terminator character(s) from the HEX table.

Valid range of characters for all readers = **01-FE**.For readers using Wedge interface, all values from **9C** to **FE** send the Space character.

ADVANCED FORMATTING



DEFINE FIELD 3 BY: EITHER

a)

field separator



Read the field separator character from the HEX table. Range of characters = **01-FE**.

discard separator



include separator



OR

b)

match character



Read the match character from the HEX table. Range of characters = **01-FE**.

OR

c)

field length



Read two numbers in the range **01** to **99** to define the field length.

OR

d)

this is the last field (variable length)



AND

Field 3 Terminators

no field terminators



1 field terminator



2 field terminators



Read the field terminator character(s) from the HEX table.

Valid range of characters for all readers = **01-FE**.

For readers using Wedge interface, all values from **9C** to **FE** send the Space character.

ADVANCED FORMATTING



DEFINE FIELD 4 BY: EITHER

a)

field separator

Read the field separator character from the HEX table. Range of characters = **01-FE**.

discard separator



include separator



OR

b)

match character

Read the match character from the HEX table. Range of characters = **01-FE**.

OR

c)

field length

Read two numbers in the range **01** to **99** to define the field length.

OR

d)

this is the last field (variable length)



AND

Field 4 Terminators

no field terminators



1 field terminator



2 field terminators



Read the field terminator character(s) from the HEX table.

Valid range of characters for all readers = **01-FE**.For readers using Wedge interface, all values from **9C** to **FE** send the Space character.

ADVANCED FORMATTING



DEFINE FIELD 5 BY: EITHER

a)

field separator

Read the field separator character from the HEX table. Range of characters = **01-FE**.

discard separator



include separator



OR

b)

match character

Read the match character from the HEX table. Range of characters = **01-FE**.

OR

c)

field length

Read two numbers in the range **01** to **99** to define the field length.

OR

d)

this is the last field (variable length)



AND

Field 5 Terminators

no field terminators



1 field terminator



2 field terminators



Read the field terminator character(s) from the HEX table.

Valid range of characters for all readers = **01-FE**.For readers using Wedge interface, all values from **9C** to **FE** send the Space character.

ADVANCED FORMATTING



7

First Additional Fixed Field

no fixed field



1 character fixed field



2 character fixed field



3 character fixed field



4 character fixed field



5 character fixed field



6 character fixed field



After selecting **one** of the Additional Fixed Field codes, read the corresponding character(s) from the HEX table. Range of characters = **01-FE**. For readers using Wedge interface, all values from **9C** to **FE** send the Space character.

Example:

4 Character Fixed Field

 $+ 4D + 41 + 49 + 4E = \text{MAIN}$

ADVANCED FORMATTING



8

Second Additional Fixed Field

no fixed field



1 character fixed field



2 character fixed field



3 character fixed field



4 character fixed field



5 character fixed field



6 character fixed field



After selecting **one** of the Additional Fixed Field codes, read the corresponding character(s) from the HEX table. Range of characters = **01-FE**. For readers using Wedge interface, all values from **9C** to **FE** send the Space character.

Example:

3 Character Fixed Field



+ 53 + 45 + 54 = SET

ADVANCED FORMATTING



9

Field Transmission

number of fields to transmit



Read one number in the range 1 to 7 for the number of fields to transmit. **Include only fields to be transmitted.**

Field Order Transmission

Read the codes corresponding to the fields to transmit in the order in which they are to be transmitted. A field can be transmitted more than once. See example.

field 1



field 2



field 3



field 4



field 5



additional field 1



additional field 2



Example:

The barcode is divided into 3 defined fields plus 1 additional fixed field.

Transmit in the order: Field 2, Additional Field 1, Field 1, Field 2.

Number of Fields



ADVANCED FORMATTING



10**Standard Formatting**

do not apply standard formatting



apply standard formatting



After performing Advanced Formatting on the barcode read, Standard Formatting (Headers, Code Length, Code ID, Terminators) can be applied to the message to be transmitted.

11**End Format Definition**

end Format 1 definition



end Format 2 definition



end Format 3 definition



end Format 4 definition





ADVANCED FORMATTING

Enable Advanced Format

◆ no Advanced Formats enabled



enable



Advanced Format 1

disable



enable



Advanced Format 2

disable



enable



Advanced Format 3

disable



enable



Advanced Format 4

disable





ADVANCED FORMATTING



No Match Result

clear data - no transmission



transmit data using standard format



This selection determines the action to be taken when codes read do not conform to the advanced format requisites (no match).

- Codes not matching can be ignored, cleared from memory and not transmitted.
- Codes not matching can be transmitted using the Standard formatting (Headers, Code Length, Code ID, Terminators).

4 REFERENCES

4.1 USB-COM AND RS232 PARAMETERS

4.1.1 Handshaking

Hardware handshaking: (RTS/CTS)

The RTS line is activated by the decoder before transmitting a character. Transmission is possible only if the CTS line (controlled by the Host) is active.

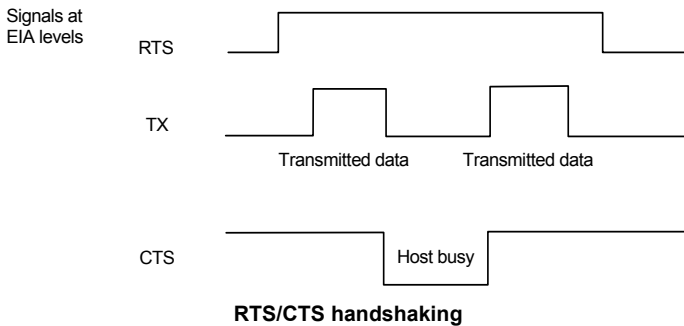

Software handshaking: (XON/XOFF)

During transmission, if the Host sends the XOFF character (13 Hex), the decoder interrupts the transmission with a maximum delay of one character and only resumes when the XON character (11 Hex) is received.

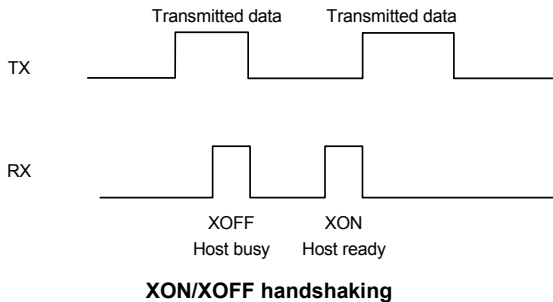

4.1.2 ACK/NACK Protocol

This parameter sets a transmission protocol in which the Host responds to the reader after every code transmitted. The Host sends an ACK character (06 HEX) in the case of good reception or the NACK character (15 HEX) requesting re-transmission, in the case of bad reception.

If the reader does not receive an ACK or NACK, transmission is ended after the RX Timeout (see par. 4.1.4).

Selection of the ACK/NACK protocol automatically disables FIFO buffering see par. 4.1.3.

4.1.3 FIFO

This parameter determines whether data (barcodes) are buffered on a First In First Out basis allowing faster data collection in certain cases for example when using slow baud rates and/or hardware handshaking.

If the FIFO buffering is enabled, codes are collected and sent out on the serial line in the order of acquisition. Several hundred characters can be collected (buffer full), after which the reader signals an error and discards any further codes until the transmission is restored.

If the FIFO buffering is disabled, each code must be transmitted before another one can be read.

4.1.4 RX Timeout

When the RS232 interface is selected, the Host can be used to configure the device by sending it command strings (see appendix A).

This parameter can be used to automatically end data reception from the Host after the specified period of time.

If no character is received from the Host, after the timeout expires, any incomplete string (any string not terminated by <CR>) is flushed from the device buffer.

4.2 PEN PARAMETERS

4.2.1 Minimum Output Pulse

This parameter sets the duration of the output pulse corresponding to the narrowest element in the barcode. In this way the code resolution is controlled by the signal sent to the decoder, independently of the physical resolution of the code read.

The shortest pulse (200 μ s) corresponds to high-resolution code emulation and therefore a shorter transfer speed to the decoder (for decoders able to work on high-resolution codes). Likewise, longer pulses correspond to low-resolution code emulation and therefore a longer transfer time to the decoder.

4.2.2 Conversion to Code 39

When using these readers it is possible to convert all codes to Code 39. By disabling this option the decoded codes will be transmitted in their original format; except for the following codes which are ALWAYS converted into Code 39 format: MSI, Plessey, Telepen, Delta IBM, Code 11, Code 16K, Code 49 and RSS Codes.

4.2.3 Overflow

This parameter generates a white space before the first bar and after the last bar of the code. The selections are as follows:

narrow = space 10 times the minimum output pulse.
medium = space 20 times the minimum output pulse.
wide = space 30 times the minimum output pulse.

4.2.4 Output and Idle Levels

The following state diagrams describe the different output and idle level combinations for Pen emulation:

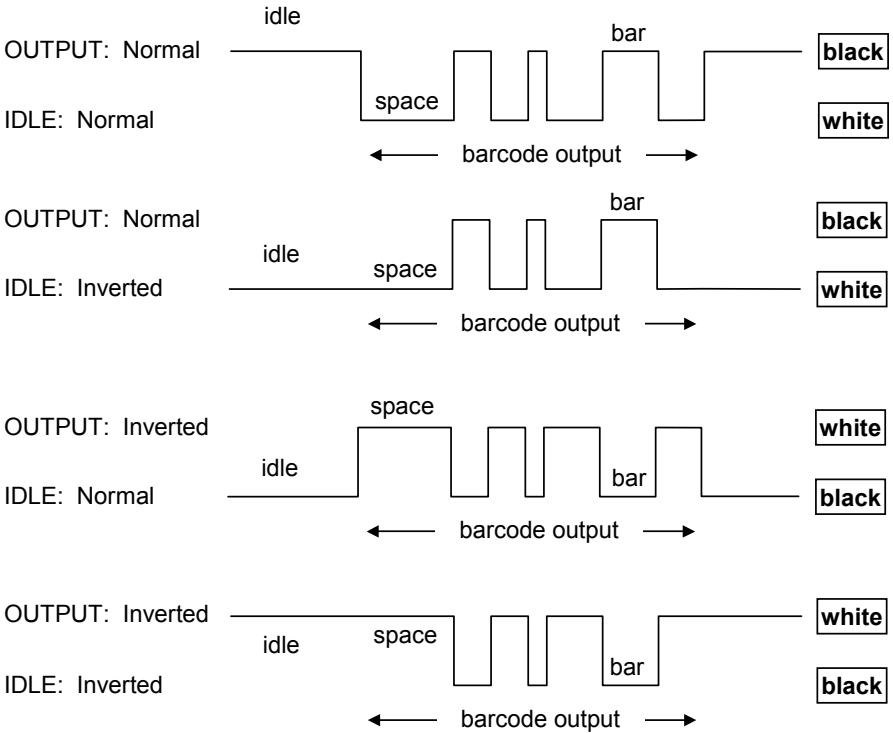

Output and Idle Levels

4.2.5 Inter-Block Delay

For the PEN Emulation interface, data are sent to the Host in fixed size blocks of 20 characters each. The inter-block delay parameter allows setting a delay between each block sent to the Host.

4.3 IBM 46XX

4.3.1 IBM Data Formatting (Transmission Format)

The IBM 46xx Series cash register recognizes the following codes:

- EAN 8 / EAN13 / UPC A / UPC E with and without Add On
- Interleaved 2/5
- Code 39
- Codabar
- Code 128
- Code 93
- Normal 2/5

The transmission format of codes belonging to this set is specified by the protocol. As the reader allows a wider set of codes to be selected, the following formats are defined to offer the user all the reading possibilities of the Datalogic product.

Conversion to Code 39 Format

Data from any code selected may be transmitted. Each code is transmitted to the Host as Code 39. Any character not included in the standard Code 39 set will be replaced with a "Space" (20 Hex).

IBM Standard Format

Only codes belonging to the above mentioned set may be transmitted. Each code transmitted to the Host is recognized by the identifier requested by the protocol. If the selected code does not belong to this set, it will not be transmitted.

Mixed IBM Standard + Code 39 Format

Data from any code selected may be transmitted. For codes belonging to the above mentioned set, the "IBM Standard Format" is applied. The "Code 39" Format applies to codes not belonging to this set.

4.4 DATA FORMAT

4.4.1 Header/Terminator Selection

The header/terminator selection is not effected by the reading of the restore default code. In fact, header and terminator default values depend on the interface selection:

RS232 and USB-COM: no header, terminator CR-LF
 WEDGE and USB-KBD: no header, terminator ENTER
 WEDGE ALT-MODE and USB-KBD-ALT-MODE: no header, terminator CR

These default values are always restored through the reading of the relative interface selection code, see chapter 2.

For the WEDGE interface, the following extended keyboard values can also be configured:

EXTENDED KEYBOARD TO HEX CONVERSION TABLE				
HEX	IBM AT IBM 3153 APPLE ADB	IBM XT	IBM 31xx, 32xx, 34xx, 37xx	Wyse Digital
83	ENTER	ENTER	FIELD EXIT	RETURN
84	TAB	TAB	TAB	TAB
85	F1	F1	F1	F1
86	F2	F2	F2	F2
87	F3	F3	F3	F3
88	F4	F4	F4	F4
89	F5	F5	F5	F5
8A	F6	F6	F6	F6
8B	F7	F7	F7	F7
8C	F8	F8	F8	F8
8D	F9	F9	F9	F9
8E	F10	F10	F10	F10
8F	F11	ESC	F11	F11
90	F12	BACKSPACE	F12	F12
91	HOME	HOME	ENTER	F13
92	END	END	RESET	F14
93	PG UP	PG UP	INSERT	F15
94	PG DOWN	PG DOWN	DELETE	F16
95	↑	↑	FIELD -	UP
96	↓	↓	FIELD +	DOWN
97	←	←	ENTER (Paddle)	LEFT
98	→	→	PRINT	RIGHT
99	ESC	ESC		ESC
9A	CTRL (Right)	CTRL (Right)		CTRL (Right)
9B	Euro	Space	Space	Space

For all readers using Wedge interface, all values from **9C** to **FE** send the Space character.

4.4.2 Set Custom Extended Header/Terminator Keys

The extended Header/Terminator keys for **Wedge Interface users** can be customized by defining them through a simple keyboard setting procedure.

For example, the Numeric Keypad keys can be set for use as Headers or Terminators by substituting the default extended keys using this procedure.

The type of computer or terminal must be selected before activating the keyboard setting command.

Press and release a key to set it.

Some characters may require more than one key pressed simultaneously during normal use (refer to the manual of your PC or terminal for keyboard use). The exact sequence must be indicated to the reader in this case pressing and releasing the different keys.

Example:

If one has to press the "Shift" and "4" keys simultaneously on the keyboard to transmit the character "\$" to the video, to set the "\$", press and release "Shift" then press and release "4".

Each pressed and released key must generate an acoustic signal on the reader, otherwise repress the key. Never press more than one key at the same time, even if this corresponds to the normal use of your keyboard.

Press "Backspace" to correct a wrong key entry. In this case the reader emits 2 beeps.

Note: "CAPS LOCK" and "NUM LOCK" must be off before starting the keyboard setting procedure. "SHIFT" must be repressed for each character and cannot be substituted by "CAPS LOCK".



Set Custom Extended Header/Terminator Keys



Read the code above.

- If the first 4 KEYS (Shift, Alt, Ctrl, and Backspace) are not available on your keyboard, you can only substitute them with keys not used, or substitute them with each other.
- Keys 5 to 28 must be defined

Press the desired keys in the following order:

The reader signals the end of the procedure with 2 beeps indicating the keys have been registered.

CUSTOM EXTENDED KEYBOARD SETTING TABLE		
		Custom
Order	HEX	KEY
01	-	Shift
02	-	Alt
03	-	Ctrl
04	-	Backspace
05	83	
06	84	
07	85	
08	86	
09	87	
10	88	
11	89	
12	8A	
13	8B	
14	8C	
15	8D	
16	8E	
17	8F	
18	90	
19	91	
20	92	
21	93	
22	94	
23	95	
24	96	
25	97	
26	98	
27	99	
28	9A	

4.5 POWER SAVE

4.5.1 Sleep State/USB Suspend

When using standard devices, this mode allows the μ P in the reader to enter a "Sleep" state for minimum power consumption. This command is only valid when hardware trigger type is selected.

Before entering Sleep mode, the following are verified:

- no commands coming from Host
- no data being transmitted to Host
- Enter Sleep Timeout ended (see par. 4.5.2)

It is possible to exit Sleep mode either by pressing the button/trigger or by inserting the reader into the Stand (only for devices with Stand Recognition Beep).

Enabling the Sleep State/USB Suspend implements Standby mode for CCD devices, see par. 4.5.3.

When using USB devices, this mode allows the device to manage Selective Suspend conditions generated by the Host Operating System in which optimizing low power consumption (ex. Windows Stand-by). It is possible to exit the Suspend mode either from the Host (ex. moving the mouse during Stand-by) or through the barcode reader. The latter, called Remote Wakeup, makes the device wake up the Host restoring the communication. Remote Wakeup is possible either by pressing the button/trigger or by putting the reader into the stand (only for devices with Stand Recognition Beep).

4.5.2 Enter Sleep Timeout

For readers that have the Sleep state enabled, this timeout determines when the reader will enter this state.

4.5.3 Standby (*only for CCD devices*)

If this command is enabled, part of the CCD circuitry shuts down (Standby), in order to optimize low power consumption when not reading. When the trigger is pressed this circuitry powers up. This mode causes a minor delay before the reader is ready.

4.6 READING PARAMETERS

4.6.1 Hand-Held and Stand Operation

These parameter groups allow setting different reading modes for Hand-Held Operation and Stand Operation:

- **Software Trigger:** the reader is set in FLASH MODE. Code reading takes place during the *flash on* time;
- **Hardware Trigger:** the code reading is started with a trigger press (ON);
- **Hardware Trigger Ready:** the illuminator is switched ON when the reader sees a code. It functions as a pointer aiming at the code to be read. The reading phase starts only when the trigger is pressed. In this mode the reader is automatically set to **trigger active level** and **one read per cycle** parameters. (Only for Hand-Held Operation).
- **Automatic:** the illuminator is switched ON when the reader sees a code. The reading phase starts automatically.
- **Always ON:** the illuminator/laser is always ON and the reader always ready for code reading.

4.6.2 Hardware Trigger Signal

This parameter determines how the reader ON state is controlled for readers with button/trigger when *Hardware Trigger* is selected:

- **trigger level:** the reader goes ON when the trigger is pressed and goes OFF when it is released
- **trigger pulse:** the reader goes ON at the first trigger press and goes OFF only at a second press

4.6.3 Trigger-Off Timeout

When this timeout is selected, the reader turns OFF automatically after the desired period of time.

4.6.4 Reads per Cycle

In general, a **reading cycle** corresponds to the ON + OFF times of a device. The resulting effects of this parameter on code reading depend on other related configuration conditions. Here are the definitions of ON and OFF times.

- For readers using the software trigger parameter (FLASH MODE), a reading cycle corresponds to the flash on + flash off times. Code reading takes place during the flash on time.
- For readers using the hardware trigger parameter, a reading cycle corresponds to a trigger press (ON) + one of the following OFF events:
 - trigger release (for *trigger active level*)
 - a second trigger press (for *trigger active pulse*)
 - trigger-off timeout* (see par. 4.6.3).

When **one read per cycle** is selected, the device decodes only one code during the ON period and immediately turns the reader OFF. It is only possible to read another code when the next ON time occurs.

In **multiple reads per cycle**, the ON period is extended so that the device can continue decoding codes until an OFF event occurs. For software trigger mode, the *flash on* period is immediately reset after each read and therefore extended. If another code is decoded before the reset *flash on* period expires, it is again reset and the effect is that the device remains ON, decoding codes until the *flash on* or *timeout* period expires.

The Safety Time parameter should be used in this case to avoid unwanted multiple reading of the same code, see par. 4.6.5.

4.6.5 Safety Time

Safety time prevents the device from immediately decoding the same code more than once. Same code consecutive reading can be disabled requiring the reader to be removed from the code (no decoding) for at least 400 ms, or a timeout can be set up to 9.9 seconds before the decoder will accept the same code. Reading is immediate if the code changes.

For *Automatic* Hand-Held or Stand Operation, the Safety Time parameter is forced to no code consecutive reading (00).

The safety time parameter is not applicable when reading stacked codes or when setting one read per cycle in hardware trigger operating mode, since these settings require voluntary action by the user.

4.6.6 Automatic Operation Aiming Light

This parameter is valid for CCD long range devices in *Automatic* Hand-Held or Stand Operation and allows an aiming light to be continuously emitted in front of the reader to facilitate the positioning of the barcode to be read.

4.6.7 Aiming System

This parameter is valid for laser readers and provides a programmable timeout for the aiming system. If enabled, the scan line emitted from the reading window is preceded by a red spot which must illuminate the code center to get the best reading performance (see figure, ①). Once the defined timeout is reached, the red spot disappears and is followed by the scan line to start the code scanning.

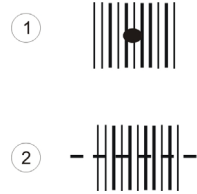

4.7 DECODING PARAMETERS



CAUTION

These parameters are intended to enhance the decoding capability of the reader for particular applications. Used incorrectly, they can degrade the reading performance or increase the possibility of a decoding error.

4.7.1 Ink-Spread

The ink-spread parameter allows the decoding of codes which are not perfectly printed because the page texture tends to absorb the ink.

4.7.2 Overflow Control

The overflow control parameter can be disabled when decoding codes printed on small surfaces, which don't allow the use of an overflow space.



This command does not effect code families 2/5, Code 128 and Code 93.

4.7.3 Interdigit Control

The interdigit control parameter verifies the interdigit spacing for code families Code 39 and Codabar.

4.8 CONFIGURATION EDITING COMMANDS

The following commands carry out their specific function and then exit the configuration environment.

Command	Description
	Restore system default configuration (see the relative Quick Reference Manual for default settings)
	Transmit the Software release. This command is not effective with the Pen emulation interface.
	Transmit the device configuration in ASCII format. This command is not effective with the Pen emulation interface.

4.9 CONFIGURATION COPY COMMAND

Procedure:

- ① Connect the **master** (correctly configured reader) and the **slave** (reader to be configured) together through two RS232 serial interface cables and external power supply. Accessory cables and power supply are available from your Datalogic distributor to provide this connection.

RS232 Cables: CAB363 & CAB364 or CAB320 & CAB328

Power Supply: PG5

- ② Using the slave device, read the Restore Default barcode and then the RS232 interface barcode from par. 2.1.2 of this manual or from the Quick Reference Manual.
- ③ With the master device, read the Configuration Copy barcode below.

Copy Configuration



The configuration will be copied from the master to the slave device. The slave device signals the end of the procedure with a series of beeps.

Note: The master device can be configured for any interface.

4.10 DEFAULT PARAMETERS FOR POS SYSTEMS

The default values for the RS232 and Data Format parameters for POS systems are listed in the following table:

	NIXDORF Mode A	FUJITSU	ICL Mode
RS232 Group			
Baud Rate	9600	9600	9600
Parity	Odd	None	Even
Data Bits	8	8	8
Stop Bits	1	1	1
Handshaking	Hardware (RTS/CTS)	None	RTS always on
ACK/NACK Protocol	Disabled	Disabled	Disabled
FIFO	Disabled	Enabled	Enabled
Inter-Character Delay	Disabled	Disabled	Disabled
RX Timeout	9.9 sec	2 sec	9.9 sec
Serial Trigger Lock	Disabled	Disabled	Disabled
Data Format Group			
Code Identifier	Custom	Custom	Custom
Header	No Header	No Header	No Header
Terminator	CR	CR	CR
Field Adjustment	Disabled	Disabled	Disabled
Code Length TX	Not Transmitted	Not Transmitted	Not Transmitted
Character Replacement	Disabled	Disabled	Disabled

The table below lists all the Code Identifiers available for POS systems:

CODE	NIXDORF Mode A	FUJITSU	ICL Mode
UPC-A	A0	A	A
UPC-E	C0	E	E
EAN-8	B	FF	FF
EAN-13	A	F	F
Code 39	M	None	C [code length]
Codabar	N	None	N [code length]
Code 128	K	None	L [code length]
Interleaved 2 of 5	I	None	I [code length]
Code 93	L	None	None
Industrial 2 of 5	H	None	H [code length]
UCC/EAN 128	P	None	L [code length]
MSI/Plessey	O	None	None
Code 11	None	None	None

4.11 FIRMWARE UPGRADES

Device firmware upgrades can be performed using the DL Sm@rtSet external Downloader utility tool from your PC either through RS232 or USB communications. The procedure for downloading is described in the DL Sm@rtSet User's Manual and in the Help window.

A special case occurs when using USB communications to upgrade devices without button/trigger.

Procedure: For devices WITHOUT button/trigger

- ① Launch the Downloader tool from the DL Sm@rtSet folder on your PC.
- ② Connect the device to the PC via USB interface.
- ③ Read the code given below to emulate the trigger press:

Trigger Press



The device will automatically be reset.

- ④ Proceed with the firmware upgrade (see the DL Sm@rtSet User's Manual for details).

A HOST CONFIGURATION STRINGS

In this section we provide a description of how to modify the device configuration using serial strings sent from the Host.

This method requires either the RS232 or USB-COM interface.

The device configuration can be changed by receiving commands from the Host through the serial interface. When this method is used, the programming sequence format is the following:

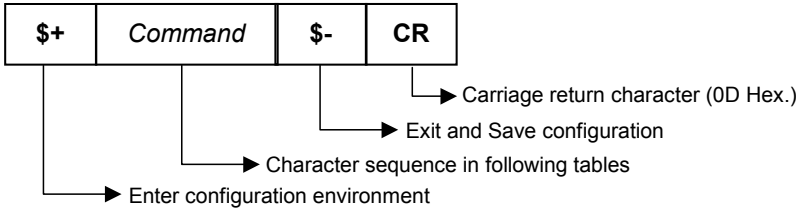

Example:

Multiple command programming sequence:

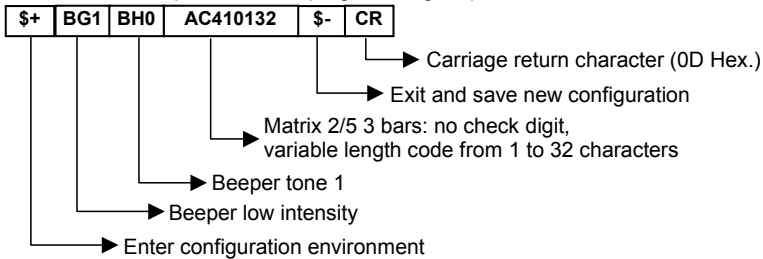

Each configuration parameter setting removes the condition previously active for that parameter.



NOTE

The device buffer can contain about 400 characters. If your programming string goes over this value, you must split it into separate groups and send each group after a delay of at least 3 seconds to give the reader time to empty the buffer and interpret the commands.

SERIAL CONFIGURATION STRINGS

ENTER/EXIT CONFIGURATION COMMANDS	
DESCRIPTION	STRING
Enter Configuration	\$+
Exit and Save Configuration	\$-
Restore Default	\$\$*
Transmit Software Release (not for PEN emulation)	\$\$!
Transmit Configuration (not for PEN emulation)	\$\$&

INTERFACE SELECTION			
DESCRIPTION		STRING	
USB	USB-KBD	UA03	
	USB-KBD-ALT-MODE	UA04	
	USB-KBD-APPLE	UA05	
	USB-COM	UA02	
	USB-IBM-Table Top	UA00	
	USB-IBM-Hand Held	UA01	
RS232	Standard	CP0	
	ICL Mode	CM0	
	Fujitsu	CM1	
	Nixdorf Mode A	CM2EC0	
WEDGE	for IBM AT	CP500	
	for IBM Terminals: 31xx, 32xx, 34xx, 37xx; make-break keyboard	CP501	
	for IBM Terminals: 31xx, 32xx, 34xx, 37xx; make-only keyboard	CP502	
	Keyboard Type for IBM Terminals 31xx, 32xx, 34xx, 37xx	typewriter	FK0
		advanced	FK1
	for IBM XT	CP503	
	for IBM Terminal 3153	CP504	
	for IBM PC Notebook	CP505	
	for IBM SURE1	CP506	
	for IBM AT - ALT mode	CP507	
	for IBM PC Notebook - ALT mode	CP508	
	for Wyse Terminal - ANSI Keyboard	CP509	
	for Wyse Terminal - PC Keyboard	CP510	
	for Wyse Terminal - ASCII Keyboard	CP511	
	for Wyse Terminal - VT220 style Keyboard	CP514	
for Digital Terminals VT2xx/3xx/4xx	CP512		
for Apple ADB Bus	CP513		
PEN EMULATION		CP6	
IBM 46xx	4501 Protocol	CP800	
	1520 Protocol	CP801	

USB		
DESCRIPTION		STRING
USB-COM		
Handshaking	disable	CE0
	RTS/CTS	CE1
	XON/XOFF	CE2
	RTS always ON	CE3
ACK/NACK Protocol	disable	ER0
	enable	ER1
FIFO	disable	EC0
	enable	EC1
Inter-character delay (<i>ms</i>)		CK00 - CK99
RX Timeout (<i>100 ms</i>)		CL00 - CL99
Serial Trigger Lock	disable	CR0
	enable	CR1ab
USB-KBD		
Keyboard nationality (not for USB-KBD-ALT-MODE)	Belgian	FJ7
	English	FJ4
	French	FJ2
	German	FJ3
	Italian	FJ1
	Spanish	FJ6
	Swedish	FJ5
	USA	FJ0
FIFO	disable	EC0
	enable	EC1
Delays	Inter-Character (<i>ms</i>)	CK00 - CK99
	Inter-Code (<i>s</i>)	FG00 - FG99
Control Character Emulation	CTRL + Shift + Key	FO0
	Ctrl + Key	FO1

a = Hex value of the ASCII character from **00** to **FE** enabling the device trigger;

b = Hex value of the ASCII character from **00** to **FE** disabling the device trigger;

RS232		
DESCRIPTION		STRING
Baud rate	300	CD1
	600	CD2
	1200	CD3
	2400	CD4
	4800	CD5
	9600	CD6
	19200	CD7
	38400	CD8
Parity	none	CC0
	even	CC1
	odd	CC2
Data bits	7	CA0
	8	CA1
	9	CA2
Stop bits	1	CB0
	2	CB1
Handshaking	disable	CE0
	RTS/CTS	CE1
	XON/XOFF	CE2
	RTS always ON	CE3
ACK/NACK Protocol	disable	ER0
	enable	ER1
FIFO	disable	EC0
	enable	EC1
Inter-character delay (ms)		CK00 - CK99
RX Timeout (100 ms)		CL00 - CL99
Serial Trigger Lock	disable	CR0
	enable	CR1 <i>ab</i>

a = Hex value of the ASCII character from **00** to **FE** enabling the device trigger;

b = Hex value of the ASCII character from **00** to **FE** disabling the device trigger;

WEDGE		
DESCRIPTION		STRING
Keyboard nationality	Belgian	FJ7
	English	FJ4
	French	FJ2
	German	FJ3
	Italian	FJ1
	Spanish	FJ6
	Swedish	FJ5
	USA	FJ0
Caps Lock	Japanese (IBM AT compatible only)	FJ8
	caps Lock ON	FE1
Caps Lock Auto-Recognition (IBM AT compatible only)	caps Lock OFF	FE0
	disable	FP0
Num Lock	enable	FP1
	Toggle Num Lock	FL1
Delays	Num Lock Unchanged	FL0
	Inter-Character (<i>ms</i>)	CK00 - CK99
Control Character Emulation	Inter-Code (<i>s</i>)	FG00 - FG99
	CTRL +Shift + Key	FO0
	Ctrl + Key	FO1

PEN		
DESCRIPTION		STRING
Operating mode	interpret (does not require \$+ or \$-)	\$]
	transparent (does not require \$+ or \$-)	[\$
Minimum output pulse	200 μ s	DG0
	400 μ s	DG1
	600 μ s	DG2
	800 μ s	DG3
	1 ms	DG4
Conversion to Code 39	1.2 ms	DG5
	disable conversion to Code 39	DA0
Output level	enable conversion to Code 39	DA1
	normal	DD0
Idle level	inverted	DD1
	normal	DE0
Overflow	inverted	DE1
	narrow overflow	DH0
	medium overflow	DH1
Inter-Block Delay (100 ms)	wide overflow	DH2
		CK00-CK99

IBM 46xx		
DESCRIPTION		STRING
IBM Data Formatting	Code 39 Format	GD0
	IBM Standard Format	GD1
	Mixed IBM Standard + Code 39 Format	GD2

DATA FORMAT		
<i>NOT FOR PEN EMULATION INTERFACES</i>		
DESCRIPTION		STRING
Code Identifier	disable	EB0
	Datalogic standard	EB1
	AIM standard	EB2
	Custom	EB3
Custom Code Identifier		EHabc
Headers	no header	EA00
	one character	EA01x
	two characters	EA02xx
	three characters	EA03xxx
	four characters	EA04xxxx
	five characters	EA05xxxxx
	six characters	EA06xxxxxx
	seven characters	EA07xxxxxxxx
eight characters	EA08xxxxxxxxx	
Terminators	no terminator	EA10
	one character	EA11x
	two characters	EA12xx
	three characters	EA13xxx
	four characters	EA14xxxx
	five characters	EA15xxxxx
	six characters	EA16xxxxxx
	seven characters	EA17xxxxxxxx
eight characters	EA18xxxxxxxxx	

a = ASCII character.
b, c, x = HEX values representing an ASCII character.

- a = ASCII character of the DATALOGIC STANDARD Code Identifier from the table on page 43.
- b = Hex value of the first Custom Code Identifier character from 00 to FE;
FF = disable Code Identifier
- c = Hex value of the second Custom Code Identifier character from 00 to FE;
FF = disable second character of Custom Code Identifier
- x = Hex value from 00 to FE

DATA FORMAT (continued)		
NOT FOR PEN EMULATION INTERFACES		
DESCRIPTION		STRING
Code Length Tx	not transmitted	EE0
	transmitted	EE1
	transmitted in 4-digit format	EE2
Field Adjustment	disabled	EF0
	right addition	EFa0d
	left addition	EFa1d
	right deletion	EFa2d
	left deletion	EFa3d
Field Adjustment Character		EGe
Character Replacement	disable character replacement	EO0
	first character replacement	EO1afg
	second character replacement	EO2afg
	third character replacement	EO3afg

a = ASCII character.

d = a number from the Hex/Numeric Table.

e, f, g = HEX values representing an ASCII character.

a = ASCII character of the DATALOGIC STANDARD Code Identifier from the table on page 43.

d = a number in the range **01 – 32** from the Hex/Numeric Table

e = Hex value from **00 to FE**

f = Hex value of the character to be replaced from **00 to FE**

g = Hex value of the new character to insert from **00 to FE**

FF = replace with no new character (remove character)

POWER SAVE		
DESCRIPTION		STRING
Scan Rate	Quarter	BT0
	Half	BT1
	Maximum	BT2
Sleep State/USB Suspend	disable	BQ0
	enable	BQ1
Enter Sleep Timeout (<i>100 ms</i>)		BR00-BR99
Standby	enable	BM0
	disable	BM1

READING PARAMETERS		
DESCRIPTION		STRING
Hand-Held Operation	software trigger	BK0
	hardware trigger	BK1
	automatic	BK2
	always on	BK3
	hardware trigger ready	BK4
Stand Operation	software trigger	BU1
	hardware trigger	BU3
	automatic	BU0
	always on	BU2
Hardware Trigger Signal	trigger active level	BA0
	trigger active pulse	BA1
Trigger-off Timeout (s)		BD00 - BD99
FLASH ON (100 ms)		BB001 - BB099
FLASH OFF (100 ms)		BB101 - BB199
Reads per Cycle	one read	BC0
	multiple reads	BC1
Safety Time (100 ms)		BE00 - BE99
Beeper Intensity	beeper off	BG0
	low intensity	BG1
	medium intensity	BG2
	high intensity	BG3
Beeper Tone	tone 1	BH0
	tone 2	BH1
	tone 3	BH2
	tone 4	BH3
Beeper Type	monotone	BJ0
	bitonal	BJ1
Beeper Length	long	BI0
	short	BI1
Good Read Spot Duration	disable	BV0
	short	BV1
	medium	BV2
	long	BV3
Stand Recognition Beep	disable	Ba0
	enable	Ba1
Automatic Operation Aiming Light	disable	Bb0
	enable	Bb1
Aiming System	disable	BX0
	300 ms	BX1
	500 ms	BX2
	1 sec	BX3

DECODING PARAMETERS		
DESCRIPTION		STRING
Ink-spread	disable	AX0
	enable	AX1
Overflow control	disable	AW1
	enable	AW0
Interdigit control	disable	AV0
	enable	AV1
Decoding Safety	one read	ED0
	two reads	ED1
	three reads	ED2
	four reads	ED3
PuzzleSolver™	disable	AU0
	enable	AU1

CODE SELECTION			
DESCRIPTION		STRING	
DISABLE ALL FAMILY CODES		AZ0	
EAN/UPC	disable EAN/UPC family		AA0
	EAN 8/EAN 13/UPC A/UPC E	without ADD ON	AA1
		with ADD ON	AA5
		with and without ADD ON	AA8
	EAN 8/EAN 13	without ADD ON	AA3
		with ADD ON 2 ONLY	AAK
		with ADD ON 5 ONLY	AAL
		with ADD ON 2 AND 5	AA6
	UPC A/UPC E	without ADD ON	AA4
		with ADD ON 2 ONLY	AAM
		with ADD ON 5 ONLY	AAN
		with ADD ON 2 AND 5	AA7
	EAN 8 check digit transmission	disable	AAG0
		enable	AAG1
	EAN 13 check digit transmission	disable	AAH0
		enable	AAH1
	UPC A check digit transmission	disable	AAI0
		enable	AAI1
	UPC E check digit transmission	disable	AAJ0
		enable	AAJ1
conversions	UPC E to UPC A	AAA	
	UPC E to EAN 13	AAB	
	UPC A to EAN 13	AAC	
	EAN 8 to EAN 13	AAD	

CODE SELECTION (continued)			
DESCRIPTION		STRING	
	ISBN Conversion codes	enable ISBN	AP1
		enable ISSN	AP2
		enable ISBN and ISSN	AP3
		disable ISBN and ISSN	AP0
Code 39	disable Code 39 family		AB0
	Standard	no check digit control	AB11
		check digit control and transmission	AB12
		check digit control without transmission	AB13
	Full ASCII	no check digit control	AB21
		check digit control and transmission	AB22
		check digit control without transmission	AB23
	CIP 39		AB3
Code 32		AB4	
code length		AB*xxxx	
2/5	disable Code 2/5 family		AC0
	Interleaved 2/5	no check digit control	AC11xxxx
		check digit control and transmission	AC12xxxx
		check digit control without transmission	AC13xxxx
	Normal 2/5 5 bars	no check digit control	AC21xxxx
		check digit control and transmission	AC22xxxx
		check digit control without transmission	AC23xxxx
	Industrial 2/5 (IATA)	no check digit control	AC31xxxx
		check digit control and transmission	AC32xxxx
		check digit control without transmission	AC33xxxx
	Matrix 2/5 3 bars	no check digit control	AC41xxxx
		check digit control and transmission	AC42xxxx
		check digit control without transmission	AC43xxxx
	CIP/HR		AC5

xxxx = ASCII numbers that define the code length where:

- First 2 digits = minimum acceptable code length.
- Second 2 digits = maximum acceptable code length.

The minimum code length must always be less than or equal to the maximum. The maximum code lengths are 99 characters.

Examples:

0132 = variable length from 1 to 32 digits in the code.

1010 = 10 digit code length only.

CODE SELECTION (continued)			
DESCRIPTION		STRING	
Codabar	disable Codabar family		AD0
	Standard	no start/stop character equality control nor transmission	AD111
		no start/stop character equality control but transmission	AD112
		start/stop character equality control but no transmission	AD121
		start/stop character equality control and transmission	AD122
	ABC Codabar	no start/stop character equality control but transmission	AD212
	Codabar ABC forced concatenation		AD232
	code length		AD*xxxx
start/stop character case in transmission	lower case	ADA0	
	upper case	ADA1	
Code 128	disable Code 128 family		AI0
	enable Code 128 - control without transmission of check digit		AI11
	enable EAN 128 - control without transmission of check digit		AI21
	add GS before Code	disable	EQ0
		enable	EQ1
	ISBT 128	enable ISBT 128	AI31
code length		AILxxxx	
Code 93	disable Code 93 family		AK0
	enable Code 93 - control without transmission of check digit		AK1
MSI	disable the family		AE0
	no check		AE1
	MOD10 no tx		AE2
	MOD10 with tx		AE3
	MOD11-MOD10 no tx		AE4
	MOD11-MOD10 with tx		AE5
	MOD10-MOD10 no tx		AE6
	MOD10-MOD10 with tx		AE7

xxxx = ASCII numbers that define the code length where:

- First 2 digits = minimum acceptable code length.
- Second 2 digits = maximum acceptable code length.

The minimum code length must always be less than or equal to the maximum. The maximum code lengths are **99** characters.

Examples:

0132 = variable length from 1 to 32 digits in the code.

1010 = 10 digit code length only.

CODE SELECTION (continued)		
DESCRIPTION		STRING
Plessey	disable the family	AF0
	Standard no check	AF11
	Standard check - with tx	AF12
	Standard check - no tx	AF13
	Anker no check	AF21
	Anker check - with tx	AF22
	Anker check - no tx	AF23
Telepen	disable the family	AL0
	Numeric no check	AL11
	Numeric check - with tx	AL12
	Numeric check - no tx	AL13
	Alpha no check	AL21
	Alpha check - with tx	AL22
	Alpha check - no tx	AL23
Delta IBM	disable the family	AH0
	no check	AH1
	Type 1 check	AH2
	Type 2 check	AH3
Code 11	disable the family	AG0
	no check	AG1
	Type C with tx	AG21
	Type C no tx	AG22
	Type K with tx	AG31
	Type K no tx	AG32
	Type C and K with tx	AG41
Type C and K no tx	AG42	
Code 16K	disable	AJ0
	enable	AJ1
Code 49	disable	AM0
	enable	AM1
RSS Codes	disable the family	AQ0
	disable RSS Expanded Linear and Stacked	AQ10
	enable RSS Expanded Linear and Stacked	AQ11
	disable RSS Limited	AQ20
	enable RSS Limited	AQ21
	disable RSS 14 Linear and Stacked	AQ30
	enable RSS 14 Linear and Stacked	AQ31

B CODE IDENTIFIER TABLE

2/5 Interleaved



2/5 Industrial



2/5 normal 5 bars



2/5 matrix 3 bars



EAN 8



EAN 13



UPC A



UPC E



EAN 8 with 2 ADD ON



EAN 8 with 5 ADD ON



EAN 13 with 2 ADD ON



EAN 13 with 5 ADD ON



UPC A with 2 ADD ON



UPC A with 5 ADD ON



UPC E with 2 ADD ON



UPC E with 5 ADD ON



Code 39



Code 39 Full ASCII



CODABAR



ABC CODABAR



Code 128



EAN 128



ISBT 128



CIP/HR



CIP/39



Code 93



Plessey Standard



Delta IBM



Code 16K



Code 49



RSS Limited



Code 32



MSI



Plessey Anker



Telepen



Code 11



RSS Expanded Linear and Stacked



RSS 14 Linear and Stacked



C HEX AND NUMERIC TABLE

CHARACTER TO HEX CONVERSION TABLE					
char	hex	char	hex	char	hex
NUL	00	*	2A	U	55
SOH	01	+	2B	V	56
STX	02	,	2C	W	57
ETX	03	-	2D	X	58
EOT	04	.	2E	Y	59
ENQ	05	/	2F	Z	5A
ACK	06	0	30	[5B
BEL	07	1	31	\	5C
BS	08	2	32]	5D
HT	09	3	33	^	5E
LF	0A	4	34		5F
VT	0B	5	35	~	60
FF	0C	6	36	a	61
CR	0D	7	37	b	62
SO	0E	8	38	c	63
SI	0F	9	39	d	64
DLE	10	:	3A	e	65
DC1	11	;	3B	f	66
DC2	12	<	3C	g	67
DC3	13	=	3D	h	68
DC4	14	>	3E	i	69
NAK	15	?	3F	j	6A
SYN	16	@	40	k	6B
ETB	17	A	41	l	6C
CAN	18	B	42	m	6D
EM	19	C	43	n	6E
SUB	1A	D	44	o	6F
ESC	1B	E	45	p	70
FS	1C	F	46	q	71
GS	1D	G	47	r	72
RS	1E	H	48	s	73
US	1F	I	49	t	74
SPACE	20	J	4A	u	75
!	21	K	4B	v	76
"	22	L	4C	w	77
#	23	M	4D	x	78
\$	24	N	4E	y	79
%	25	O	4F	z	7A
&	26	P	50	{	7B
'	27	Q	51		7C
(28	R	52	}	7D
)	29	S	53	~	7E
		T	54	DEL	7F

CHARACTER TO HEX CONVERSION TABLE					
char	hex	char	hex	char	hex
€	80	ª	AA	Õ	D5
□	81	«	AB	Ö	D6
,	82	¬	AC	×	D7
ENTER	83	-	AD	Ø	D8
TAB	84	®	AE	Ù	D9
F1	85	—	AF	Ú	DA
F2	86	°	B0	Û	DB
F3	87	±	B1	Ü	DC
F4	88	²	B2	Ý	DD
F5	89	³	B3	Þ	DE
F6	8A	´	B4	ß	DF
F7	8B	µ	B5	à	E0
F8	8C	¶	B6	á	E1
F9	8D	·	B7	â	E2
F10	8E	¸	B8	ã	E3
F11	8F	¹	B9	ä	E4
F12	90	º	BA	å	E5
HOME	91	»	BB	æ	E6
END	92	¼	BC	ç	E7
Pg UP	93	½	BD	è	E8
Pg Down	94	¾	BE	é	E9
↑	95	¿	BF	ê	EA
↓	96	À	C0	ë	EB
←	97	Á	C1	ì	EC
→	98	Â	C2	í	ED
ESC	99	Ã	C3	î	EE
CTRL(Right)	9A	Ä	C4	ï	EF
€	9B	Å	C5	ð	F0
œ	9C	Æ	C6	ñ	F1
□	9D	Ç	C7	ò	F2
ž	9E	È	C8	ó	F3
ÿ	9F	É	C9	ô	F4
NBSP	A0	Ê	CA	õ	F5
ı	A1	Ë	CB	ö	F6
¢	A2	Ì	CC	÷	F7
£	A3	Í	CD	ø	F8
¤	A4	Î	CE	ù	F9
¥	A5	Ï	CF	ú	FA
¦	A6	Ð	D0	û	FB
§	A7	Ñ	D1	ü	FC
¨	A8	Ò	D2	ý	FD
©	A9	Ó	D3	Reserved	FE
		Ô	D4	Reserved	FF

HEX / NUMERIC TABLE



Backspace



Cancels an incomplete configuration sequence

Australia

Datalogic Scanning Pty Ltd
Telephone: [61] (2) 9870 3200
australia.scanning@datalogic.com

France and Benelux

Datalogic Scanning Sarl
Telephone: [33].01.64.86.71.00
france.scanning@datalogic.com

Germany

Datalogic Scanning GmbH
Telephone: 49 (0) 61 51/93 58-0
germany.scanning@datalogic.com

India

Datalogic Scanning India
Telephone: 91- 22 - 64504739
india.scanning@datalogic.com

Italy

Datalogic Scanning SpA
Telephone: [39] (0) 39/62903.1
italy.scanning@datalogic.com

Japan

Datalogic Scanning KK
Telephone: 81 (0)3 3491 6761
japan.scanning@datalogic.com

Latin America

Datalogic Scanning, Inc
Telephone: (305) 591-3222
latinamerica.scanning@datalogic.com

Singapore

Datalogic Scanning Singapore PTE LTD
Telephone: (65) 6435-1311
singapore.scanning@datalogic.com

Spain and Portugal

Datalogic Scanning Sarl Sucursal en España
Telephone: 34 91 746 28 60
spain.scanning@datalogic.com

United Kingdom

Datalogic Scanning LTD
Telephone: 44 (0) 1923 809500
uk.scanning@datalogic.com



www.scanning.datalogic.com

Datalogic Scanning, Inc.

959 Terry Street
Eugene, OR 97402
USA
Telephone: (541) 683-5700
Fax: (541) 345-7140

